

Purity



По вопросам продаж и поддержки обращайтесь:

Алматы (7273)495-231
Архангельск (8182)63-90-72
Астрахань (8512)99-46-04
Барнаул (3852)73-04-60
Белгород (4722)40-23-64
Брянск (4832)59-03-52
Владивосток (423)249-28-31
Волгоград (844)278-03-48
Вологда (8172)26-41-59
Воронеж (473)204-51-73
Екатеринбург (343)384-55-89
Иваново (4932)77-34-06
Ижевск (3412)26-03-58
Иркутск (395)279-98-46
Россия (495)268-04-70

Казань (843)206-01-48
Калининград (4012)72-03-81
Калуга (4842)92-23-67
Кемерово (3842)65-04-62
Киров (8332)68-02-04
Краснодар (861)203-40-90
Красноярск (391)204-63-61
Курск (4712)77-13-04
Липецк (4742)52-20-81
Магнитогорск (3519)55-03-13
Москва (495)268-04-70
Мурманск (8152)59-64-93
Набережные Челны (8552)20-53-41
Нижний Новгород (831)429-08-12
Киргизия (996)312-96-26-47

Новокузнецк (3843)20-46-81
Новосибирск (383)227-86-73
Омск (3812)21-46-40
Орел (4862)44-53-42
Оренбург (3532)37-68-04
Пенза (8412)22-31-16
Пермь (342)205-81-47
Ростов-на-Дону (863)308-18-15
Рязань (4912)46-61-64
Самара (846)206-03-16
Санкт-Петербург (812)309-46-40
Саратов (845)249-38-78
Севастополь (8692)22-31-93
Симферополь (3652)67-13-56
Казахстан (7172)727-132

Смоленск (4812)29-41-54
Сочи (862)225-72-31
Ставрополь (8652)20-65-13
Сургут (3462)77-98-35
Тверь (4822)63-31-35
Томск (3822)98-41-53
Тула (4872)74-02-29
Тюмень (3452)66-21-18
Ульяновск (8422)24-23-59
Уфа (347)229-48-12
Хабаровск (4212)92-98-04
Челябинск (351)202-03-61
Череповец (8202)49-02-64
Ярославль (4852)69-52-93



CONTENTS

END SUCTION/SUCCIÓN EXTREMO/FIN D'ASPIRATION

PST/PST4 Close coupled centrifugal pump
PST/PST4 Bomba centrífuga acoplado cerrado
PST/PST4 Pompe centrifuge à couple fermé 1

PS/PS4 End suction centrifugal pump
PS/PS4 Bomba centrífuga de succión final
PS/PS4 Pompe centrifuge aspiration finale 7

YE3 Electric motor TEFC type
YE3 Motor eléctrico tipo TEFC
YE3 Moteur électrique type TEFC 21

PD Diesel engine for pump
PD Motor diesel para bomba
PD Moteur diesel pour pompe 25

MULTISTAGE/MULTIETAPA/MULTICELLULAIRE

PV Vertical multistage centrifugal pump
PV Bomba centrífuga multietapa vertical
PV Pompe centrifuge multicellulaire verticale 27

PVT/PVS Stainless steel 304 vertical multistage pump
PVT/PVS Bomba de etapas múltiples inox304
PVT/PVS Pompe multicellulaire verticale inox304 31

SYSTEM/SISTEMA/SYSTÈME

PEJ/PEJ/PDJ/PVK Fire fighting system
PEJ/PEJ/PDJ/PVK Sistema de contra incendio
PEJ/PEJ/PDJ/PVK Système anti-incendie 39

INLINE/EN LINEA/EN LIGNE

PTD Inline circulation pump
PTD Bomba de circulación en línea
PTD Pompe de circulation en ligne 57

PT Vertical inline pump
PT Bomba vertical en-línea
PT Pompe en ligne verticale 77

CENTRIFUGAL/CENTRIFUGA/CENTRIFUGE

PW Same port centrifugal pump
PW Bomba centrífuga misma puerto
PW Pompe centrifuge même port 61

PC/P2C Thread port centrifugal pump
PC/P2C Bomba centrífuga roscada
PC/P2C Pompe centrifuge à orifice fileté 65

PZ Stainless steel standard pump
PZ Bomba normalizada en acero inoxidable
PZ Pompe standard en acier inoxydable 73

PG Single suction centrifugal pump
PG Bomba centrífuga de succión simple
PG Pompe centrifuge à aspiration unique 81

SPLIT CASE/CÁMARA PARTIDA/ÉTUI SPLIT

PSC Double suction split case pump
PSC Succión doble bomba de cámara partida
PSC Pompe à double corps d'aspiration 87

SELF-PRIMING/AUTOCEBANTE/AUTO-AMORÇAGE

PXZ Self-priming centrifugal pump
PXZ Bomba centrífuga autocebante
PXZ Pompe centrifuge auto-amorçante 93

PZW Self-priming non-blocking sewage pump
PZW Bomba de aguas residuales autocebante
PZW Pompe d'égout autobloquante non bloquante 95

SUBMERSIBLE/SUMERGIBLE/SUBMERSIBLE

WQV Vortex cutting submersible pump
WQV Vórtice bomba sumergible de corte
WQV Pompe submersible de coupe Vortex 97

WQ Submersible sewage pump
WQ Bomba sumergible para aguas sucias
WQ Pompe submersible pour eaux usées 101

WATERSUPPLY/SUMINISTRO AGUA/ALIMENTATION

PBWS Non-negative pressure water supply system
PBWS Sistema de suministro presión no negativa
PBWS Système d'alimentation à pression non négative 107

PERFORMANCE CURVE/CURVA/COURBE 111



reliable pumps for project





PST



PST(B)



PST $n \approx 2900 \text{ rpm}$
Close coupled centrifugal pump
Bomba centrífuga acoplado cerrado
Pompe centrifuge à couple fermé



PST(C)



PST(B/C)
 30-160kW



NEW/NUEVO/NOUVEAU

DESCRIPTION/DESCRIPCIONES/DESCRIPTION

- ◆ New EN733 standard centrifugal pump
- ◆ Original design by PURITY (Patent no.201530478502.0)
- ◆ Both square motor & round motor available
- ◆ YE3 high efficient motor, with protection IP55 class F
- ◆ Pump case with anti-corrosive coating
- ◆ Galvanized counter flange with bolts, nuts and gaskets
- ◆ Quality NSK bearing, wear resistance mechanical seal
- ◆ Nuevas bombas centrífugas según norma EN733
- ◆ Diseño original de PURITY (Patente no.201530478502.0)
- ◆ Motor redondo y cuadrado disponible
- ◆ Motor de eficiencia YE3 con Protección IP55 clase F
- ◆ Cuerpo de bomba con tratamiento anti-corrosión
- ◆ Contrabridas galvanizadas con pernos, tuercas y empaques
- ◆ Rodamiento de marca NSK y cierre mecánico personalizado
- ◆ Nouvelle pompe centrifuge standard EN733
- ◆ Design original par PURITY (Brevet no.201530478502.0)
- ◆ Moteur carré et moteur rond disponibles
- ◆ Moteur haute efficacité YE3, avec protection IP55 classe F
- ◆ Boîtier de pompe avec revêtement anti-corrosif
- ◆ Contre-bride galvanisée avec boulons, écrous et joints
- ◆ Roulement NSK qualité, joint mécanique de résistance à l'usure

APPLICATIONS/APLICACIONES/APPLICATIONS

- ◆ Suitable for use with clean water and liquids that are not chemically aggressive towards the materials from which the pump is made. The EN733 centrifugal pumps are recommended for use in water supply, cleaning sets, pressure boosting, firefighting sets, irrigation, industrial applications, water circulation in climatization sets, agricultural.
- ◆ Son recomendadas para bombear agua limpia, sin partículas abrasivas y líquidos químicamente no agresivos con los materiales que constituyen la bomba. Las Bombas centrífugas según EN733 diseñadas para abastecimiento hídrico, instalaciones de lavado, presurización, contraincendio, irrigación, industria, circulación del agua, agricultura.
- ◆ Convient pour une utilisation avec de l'eau propre et des liquides qui ne sont pas chimiquement agressifs envers les matériaux dont la pompe est faite. Les pompes centrifuges EN733 sont recommandées pour une utilisation dans l'alimentation en eau, kits de nettoyage, boosters de pression, kits anti-incendie, irrigation, industriels applications, circulation de l'eau dans les groupes de climatization, agricole.

USING LIMITS/LÍMITES UTILIZACIÓN/UTILISATION LIMITES

- ◆ Liquid temperature between -10°C and $+120^{\circ}\text{C}$
- ◆ Ambient temperature between -10°C and $+50^{\circ}\text{C}$
- ◆ Max. working pressure **16 bar**
- ◆ Continuous service **S1**
- ◆ Temperatura del líquido de -10°C hasta $+120^{\circ}\text{C}$
- ◆ Temperatura ambiente de -10°C hasta $+50^{\circ}\text{C}$
- ◆ Presión máxima en el cuerpo de la bomba **16 bar**
- ◆ Funcionamiento continuo **S1**
- ◆ Température du liquide entre -10°C et $+120^{\circ}\text{C}$
- ◆ Température ambiante entre -10°C et $+50^{\circ}\text{C}$
- ◆ Max. pression de service **16 bar**
- ◆ Service continu **S1**

MODEL CODE/CÓDIGO MODELO/COE MODÈLE

For example/Par ejemplo/Par exemple

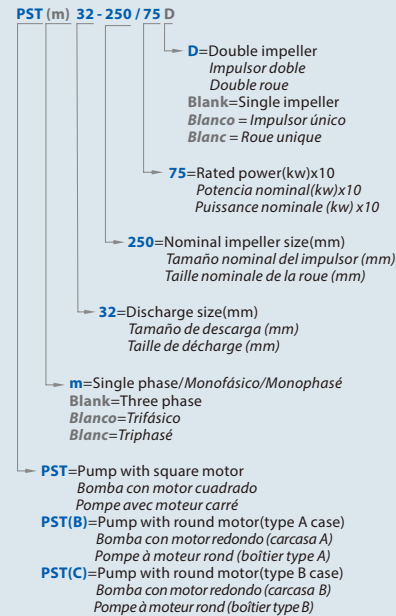

TECHNICAL SHEET/HOJA TÉCNICA/FICHE TECHNIQUE

Model/Modelo/Modèle	PST	
Capacity/Caudal/Débit	0-400	m ³ /h
Head/Altura/Hauteur	0-151	m
DN	32-125	mm
Speed/Velocidad/Vitesse	2900	rpm
T max	120	°C
Power/Potencia/Puiss.	0.75-160	kW
Voltage/Voltaje/Tension	220/380/400/440	V
HZ	50	
Class/Clase/Classe	Class F	
IP	IP 55	
Duty/Servicio/Devoir	S1 continuous	
Casing/Cuerpo/Corps	Grey Cast iron Hierro fundido gris Fonte grise	
Impeller/Impulsor/Roue	Cast iron/AlSi 304/Brass Hierro fundido/Inox304/Bronce Fonte/Inox304/Laiton	
Shaft/Eje/Arbre	45# steel/AlSi304 45 # acero/Inox304 45 # acier/Inox304	
Shaft seal/Sello/Scellé	Mechanical Seal Sello mecánico Garniture mécanique	
Bearing/Rodamiento/Palier	Grease lubrication rolling bearing Rodamientos lubricación con grasa Roulement lubrification à la graisse	

TECHNICAL DATA/DATOS TÉCNICOS/DONNÉES TECHNIQUES

50 Hz n=2900 1/min

MODEL MODELO MODÈLE	DN mm	Power Potencia Puissance		Q=DELIVERY/CAUDAL/DÉBIT																
		kw	hp	us	26	40	66	79	106	119	159	185	211	238	317	370	396	476	529	608
				gpm	l/min	m³/h	0	100	150	250	300	400	450	600	700	800	900	1200	1400	1500
PST 32-125/07	50x32	0.75	1	17.5	16.7	15	12	9	-	-	-	-	-	-	-	-	-	-	-	-
PST 32-125/11	50x32	1.1	1.5	22	21	19.7	16.5	14.5	9	-	-	-	-	-	-	-	-	-	-	-
PST 32-160/15	50x32	1.5	2	25.4	23.7	22.5	18.5	15.8	-	-	-	-	-	-	-	-	-	-	-	-
PST 32-160/22	50x32	2.2	3	31	29.6	28.5	24.5	22	15	-	-	-	-	-	-	-	-	-	-	-
PST 32-160/30	50x32	3	4	35	34.3	32.5	28	25.5	19	15	-	-	-	-	-	-	-	-	-	-
PST 32-200/30	50x32	3	4	44.2	42	39.8	35.2	32.2	24.6	19.8	-	-	-	-	-	-	-	-	-	-
PST 32-200/40	50x32	4	5.5	54.5	52	50	45.5	42.3	35	30.3	-	-	-	-	-	-	-	-	-	-
PST 32-250/55	50x32	5.5	7.5	60	59.5	59	55	50.2	34.5	-	-	-	-	-	-	-	-	-	-	-
PST 32-250/75	50x32	7.5	10	69.5	69	68.5	66	63	53	-	-	-	-	-	-	-	-	-	-	-
PST 32-250/92	50x32	9.2	12.5	75	75	74.5	72	69	59	-	-	-	-	-	-	-	-	-	-	-
PST 32-250/110	50x32	11	15	90	89.5	88	82	78	66	-	-	-	-	-	-	-	-	-	-	-
PST 32-250/150	50x32	15	20	97	96.5	96	90	86	73	-	-	-	-	-	-	-	-	-	-	-
PST 32-250/55D	50x32	5.5	7.5	79.5	74.7	71.8	63	56	37.5	-	-	-	-	-	-	-	-	-	-	-
PST 32-250/75D	50x32	7.5	10	95	93	91	83	76	57.8	-	-	-	-	-	-	-	-	-	-	-
PST 40-125/11	65x40	1.1	1.5	14.7	-	-	-	13	11.5	10.1	5.8	-	-	-	-	-	-	-	-	-
PST 40-125/15	65x40	1.5	2	18.1	-	-	-	17	15	13.9	10	6	-	-	-	-	-	-	-	-
PST 40-125/22	65x40	2.2	3	24.5	-	-	-	23.2	21.5	20.2	16	13	8.3	-	-	-	-	-	-	-
PST 40-160/30	65x40	3	4	31.8	-	-	-	29.5	27.5	26.3	21.5	17.5	-	-	-	-	-	-	-	-
PST 40-160/40	65x40	4	5.5	38	-	-	-	36	34	33	28.5	25	20.1	-	-	-	-	-	-	-
PST 40-200/55	65x40	5.5	7.5	46	-	-	-	43.8	41.3	40.1	35	30	-	-	-	-	-	-	-	-
PST 40-200/75	65x40	7.5	10	57	-	-	-	53.6	51.5	50	45	41	36.5	-	-	-	-	-	-	-
PST 40-250/92	65x40	9.2	12.5	64	-	-	-	59	56.5	55	49.5	45	39.8	-	-	-	-	-	-	-
PST 40-250/110	65x40	11	15	72	-	-	-	67.5	65	63.5	57.5	52.2	47	-	-	-	-	-	-	-
PST 40-250/150	65x40	15	20	84.5	-	-	-	79.3	77.3	75.2	70	66	61	-	-	-	-	-	-	-
PST 40-250/185	65x40	18.5	25	90	-	-	-	85.5	82.8	80.7	75.8	70.5	66.5	-	-	-	-	-	-	-
PST 50-125/22	65x50	2.2	3	17	-	-	-	-	15.4	14	12.8	11.5	6.5	-	-	-	-	-	-	-
PST 50-125/30	65x50	3	4	20	-	-	-	-	18.8	18	17	15.6	11	-	-	-	-	-	-	-
PST 50-125/40	65x50	4	5.5	24	-	-	-	-	23.1	23	21.5	20.3	15.8	11.8	-	-	-	-	-	-
PST 50-160/55	65x50	5.5	7.5	32	-	-	-	-	30.6	30	28	26.6	20.5	14.8	-	-	-	-	-	-
PST 50-160/75	65x50	7.5	10	40	-	-	-	-	38	37	36	34.4	29	24	21	-	-	-	-	-
PST 50-200/92	65x50	9.2	12.5	50.5	-	-	-	-	46.8	45	43	40.9	32.5	26.7	-	-	-	-	-	-
PST 50-200/110	65x50	11	15	57.5	-	-	-	-	53.5	52	50	47.5	40	34	29	-	-	-	-	-
PST 50-200/150	65x50	15	20	62	-	-	-	-	58	56.5	54.5	52	44.5	39	35.5	-	-	-	-	-
PST 50-250/150	65x50	15	20	68.5	-	-	-	-	64	63	61.5	59	50	41	-	-	-	-	-	-
PST 50-250/185	65x50	18.5	25	79	-	-	-	-	75.8	74.8	74	71.5	63.5	55.5	47	-	-	-	-	-
PST 50-250/220	65x50	22	30	89.5	-	-	-	-	86	85.3	84	81.5	73.5	63.5	57	-	-	-	-	-
PST 65-125/40	80x65	4	5.5	19	-	-	-	-	-	-	17.3	16.8	14.5	13	11.8	-	-	-	-	-
PST 65-125/55	80x65	5.5	7.5	23	-	-	-	-	-	-	21.3	20.9	19	17.5	16.7	13.7	-	-	-	-
PST 65-125/75	80x65	7.5	10	27	-	-	-	-	-	-	26	25.6	24.5	23	22.5	20	18	-	-	-
PST 65-160/92	80x65	9.2	12.5	33	-	-	-	-	-	-	31.5	30	28	27.1	24	21.5	-	-	-	-
PST 65-160/110	80x65	11	15	36	-	-	-	-	-	-	34.5	33	31.5	30.8	28	25.5	-	-	-	-
PST 65-160/150	80x65	15	20	42	-	-	-	-	-	-	41	40	38.5	37.8	35	33	29.5	-	-	-
PST 65-200/150	80x65	15	20	45	-	-	-	-	-	-	45.5	43	41	40.2	36.5	34	-	-	-	-
PST 65-200/185	80x65	18.5	25	52	-	-	-	-	-	-	52.3	51	49	48.2	44.5	42	-	-	-	-
PST 65-200/220	80x65	22	30	59	-	-	-	-	-	-	59.5	58	56	55	52	49.5	44.5	-	-	-
PST 65-250/220	80x65	22	30	64.8	-	-	-	-	-	-	64.7	62	60	58.5	53	50	-	-	-	-
PST 65-250/300	80x65	30	40	80	-	-	-	-	-	-	79.8	77.5	75.5	74.5	70	66	58	-	-	-
PST 65-250/370	80x65	37	50	92	-	-	-	-	-	-	90.5	88.5	87	85	80.5	78	68	-	-	-

PSTB PSTC also available/también disponible/aussi disponible

Performance curve in page/Curva en página/Courbe en page 111-129

TECHNICAL DATA/DATOS TÉCNICOS/DONNÉES TECHNIQUES

50 Hz n=2900 1/min

MODEL MODELO MODÈLE	DN mm	Power Potencia Puissance		Q=DELIVERY/CAUDAL/DÉBIT																
		kw	hp	us	264	396	529	634	793	881	925	969	1057	1233	1322	1586	1762			
				gpm	l/min	m³/h	0	1000	1500	2000	2400	3000	3333	3500	3667	4000	4667	5000	6000	6667
PST 65-315/450	80x65	45	60	102	98	94.5	90	83	-	-	-	-	-	-	-	-	-	-	-	-
PST 65-315/550	80x65	55	75	122	120	114.5	110	100	76	-	-	-	-	-	-	-	-	-	-	-
PST 65-315/750	80x65	75	100	141	141	134.5	130	120	96	78	65.5	-	-	-	-	-	-	-	-	-
PST 65-315/900	80x65	90	125	151	150	144.5	140	130	106	88	75.5	-	-	-	-	-	-	-	-	-
PST 80-125/40	100x80	4	5.5	17	15	12.3	7.5	-	-	-	-	-	-	-	-	-	-	-	-	-
PST 80-125/55	100x80	5.5	7.5	21	19.6	17.4	13.4	9.5	-	-	-	-	-	-	-	-	-	-	-	-
PST 80-125/75	100x80	7.5	10	26	24.8	23	19.5	16.5	-	-	-	-	-	-	-	-	-	-	-	-
PST 80-160/110	100x80	11	15	28	27	27.3	24.5	21.1	16	-	-	-	-	-	-	-	-	-	-	-
PST 80-160/150	100x80	15	20	34	32.6	32.5	30.2	27	22.1	18.5	16.7	-	-	-	-	-	-	-	-	-
PST 80-160/185	100x80	18.5	25	39	38.5	38	36.7	33.6	28.8	25.3	23.5	-	-	-	-	-	-	-	-	-
PST 80-160/220	100x80	22	30	44	43.5	43	41.7	38.6	33.8	30.3	28.5	-	-	-	-	-	-	-	-	-
PST 80-200/220	100x80	22	30	48	47.7	47.5	43.5	39.2	32.5	27.2	24.5	-	-	-	-	-	-	-	-	-
PST 80-200/300	100x80	30	40	60	59.7	59.5	57	53.1	47	42.7	40.5	-	-	-	-	-	-	-	-	-
PST 80-250/370	100x80	37	50	71.5	70.9	70.5	65.5	59.3	51	43.2	38.5	-	-	-	-	-	-	-	-	-
PST 80-250/450	100x80	45	60	88	86.7	86	83.6	78.5	70.5	60	51	-	-	-	-	-	-	-	-	-
PST 80-250/550	100x80	55	75	94.5	94.5	94.5	91.8	87	79.5	72.1	68.3	-	-	-	-	-	-	-	-	-
PST 80-315/450	100x80	45	60	85	84	82.6	82	78	68.3	61	56	-	-	-	-	-	-	-	-	-
PST 80-315/550	100x80	55	75	98	97	95.6	95	91	81.3	74	69	-	-	-	-	-	-	-	-	-
PST 80-315/750	100x80	75	100	124	123	121.6	121	117	107.3	100	95	90	80.8	-	-	-	-	-	-	-
PST 80-315/900	100x80	90	125	144	143	141.6	141	137	127.3	120	115	110	100.8	-	-	-	-	-	-	-
PST 100-160/150	125x100	15	20	35	33.5	32.5	30	27.8	24.5	21.5	20	18.3	15	-	-	-	-	-	-	-
PST 100-160/185	125x100	18.5	25	38.5	37.5	36.5	34.3	32.2	29	25.7	24	22	18	-	-	-	-	-	-	-
PST 100-160/220	125x100	22	30	43	41	40	37.6	35.2	31.5	28.5	27	25.3	22	-	-	-	-	-	-	-
PST 100-200/220	125x100	22	30	38.5	36.7	35.7	33.8	31.7	28.5	26.8	26	25	22.9	16.3	13	-	-	-	-	-
PST 100-200/300	1																			



PS $n \approx 2900 \text{ rpm}$
End suction centrifugal pump
Bomba centrífuga de succión final
Pompe centrifuge aspiration finale



PS



PSM



PSB



PSBM

NEW/NUEVO/NOUVEAU

DESCRIPTION/DESCRIPCIONES/DESCRIPTION

- ◆ Complete range with a full series of end suction pumps
 - ◆ Original design by PURITY (Patent no.201530478502.0)
 - ◆ Outstanding reliability for operation in any application
 - ◆ YE3 high efficient motor, with protection IP55 class F
 - ◆ Pump case with anti-corrosive coating
 - ◆ Customize casting logo on the bearing house as request
 - ◆ Quality NSK bearing, wear resistance mechanical seal
- ◆ Gama completa con una serie completa de bombas
 - ◆ Diseño original de PURITY (Patente no.201530478502.0)
 - ◆ Excelente fiabilidad para cualquier aplicación
 - ◆ Motor de eficiencia YE3 con Protección IP55 clase F
 - ◆ Cuerpo de bomba con tratamiento anti-corrosión
 - ◆ Personalizar el logotipo de fundición en la caja como solicitud
 - ◆ Rodamiento de marca NSK y cierre mecánico personalizado
- ◆ Gamme complète avec une série complète de pompes
 - ◆ Design original par PURITY (Brevet no.201530478502.0)
 - ◆ Fiabilité exceptionnelle pour n'importe quelle application
 - ◆ Moteur haute efficacité YE3, avec protection IP55 classe F
 - ◆ Boîtier de pompe avec revêtement anti-corrosif
 - ◆ Personnalisez le logo de coulée sur le palier comme demande
 - ◆ Roulement NSK qualité, joint mécanique de résistance à l'usure

APPLICATIONS/APLICACIONES/APPLICATIONS

- ◆ The impressive range end-suction pumps is compatible with an array of application areas, including water intake, heating, industrial pressure boosting, industrial liquid transfer, air-conditioning, district cooling, irrigation, fire fighting and many more.
- ◆ La impresionante gama de bombas de succión final es compatible con una variedad de áreas de aplicación, que incluyen la toma de agua, calefacción, aumento de la presión industrial, transferencia de líquido industrial, aire acondicionado, refrigeración urbana, riego, extinción de incendios y muchos más.
- ◆ La gamme impressionnante de pompes à aspiration finale est compatible avec un large éventail de domaines d'application, notamment prise d'eau, chauffage, surpression industrielle, transfert de liquide industriel, climatisation, refroidissement urbain, l'irrigation, lutte contre l'incendie et bien d'autres.

USING LIMITS/LÍMITES UTILIZACIÓN/UTILISATION LIMITES

- ◆ Liquid temperature between -10°C and $+120^{\circ}\text{C}$
- ◆ Ambient temperature between -10°C and $+50^{\circ}\text{C}$
- ◆ Max. working pressure **20 bar**
- ◆ Continuous service **S1**
- ◆ Temperatura del líquido de -10°C hasta $+120^{\circ}\text{C}$
- ◆ Temperatura ambiente de -10°C hasta $+50^{\circ}\text{C}$
- ◆ Presión máxima en el cuerpo de la bomba **20 bar**
- ◆ Funcionamiento continuo **S1**
- ◆ Température du liquide entre -10°C et $+120^{\circ}\text{C}$
- ◆ Température ambiante entre -10°C et $+50^{\circ}\text{C}$
- ◆ Max. pression de service **20 bar**
- ◆ Service continu **S1**

MODEL CODE/CÓDIGO MODELO/CODE MODÈLE

For example/Par ejemplo/Par exemple

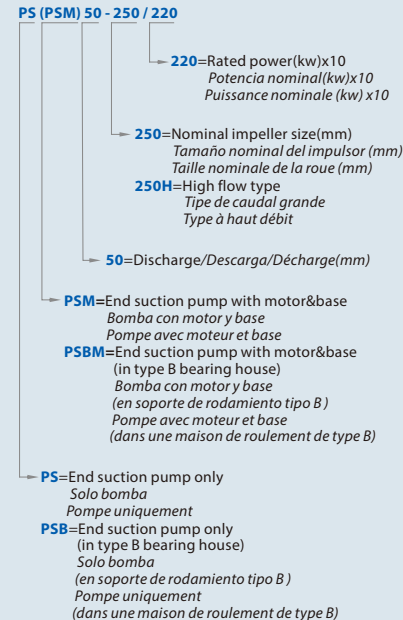

TECHNICAL SHEET/HOJA TÉCNICA/FICHE TECHNIQUE

Model/Modelo/Modèle	PS	
Capacity/Caudal/Débit	0-1000	m ³ /h
Head/Altura/Hauteur	0-164	m
DN	32-150	mm
Speed/Velocidad/Vitesse	2900	rpm
T max	120	°C
Power/Potencia/Puiss.	1.5-315	kW
Casing/Cuerpo/Corps	Grey cast iron Hierro fundido gris Fonte grise	
Impeller/Impulsor/Roue	Cast iron/AISI 304/Brass Hierro fundido/Inox304/Bronce Fonte/Inox 304/Laiton	
Shaft/Eje/Arbre	45# steel/AISI 304 45 # acero/Inox304 45 # acier/Inox 304	
Shaft seal/Sello/Scellé	Mechanical Seal Sello mecánico Garniture mécanique	
Bearing/Rodamiento/Palier	Grease lubrication rolling bearing Rodamientos lubricación con grasa Roulement lubrification à la graisse	

TECHNICAL DATA/DATOS TÉCNICOS/DONNÉES TECHNIQUES

50 Hz n=2900 1/min

MODEL MODELO MODÈLE	DN	Impr Φ	Power Potencia Puissance	Q=DELIVERY/CAUDAL/DÉBIT																		
				0	26	40	66	79	106	119	159	185	211	238	317	370	396	476	529	608	793	925
				H=Head/Altura/Hauteur(m)																		
				0	6	9	15	18	24	27	36	42	48	54	72	84	90	108	120	138	180	210
				0	6	9	15	18	24	27	36	42	48	54	72	84	90	108	120	138	180	210
PS 32-160/15	50x32	142	1.5	2	25.4	23.7	22.5	18.5	15.8	-	-	-	-	-	-	-	-	-	-	-	-	
PS 32-160/22	50x32	158	2.2	3	31	29.6	28.5	24.5	22	15	-	-	-	-	-	-	-	-	-	-	-	
PS 32-160/30	50x32	168	3	4	35	34.3	32.5	28	25.5	19	15	-	-	-	-	-	-	-	-	-	-	
PS 32-200/30	50x32	190	3	4	44.2	42	39.8	35.2	32.2	24.6	19.8	-	-	-	-	-	-	-	-	-	-	
PS 32-200/40	50x32	204	4	5.5	54.5	52	50	45.5	42.3	35	30.3	-	-	-	-	-	-	-	-	-	-	
PS 32-250/55	50x32	208	5.5	7.5	60	59.5	59	55	50.2	34.5	-	-	-	-	-	-	-	-	-	-	-	
PS 32-250/75	50x32	230	7.5	10	69.5	69	68.5	66	63	53	-	-	-	-	-	-	-	-	-	-	-	
PS 32-250/92	50x32	237	9.2	12.5	75	75	74.5	72	69	59	-	-	-	-	-	-	-	-	-	-	-	
PS 32-250/110	50x32	250	11	15	90	89.5	88	82	78	66	-	-	-	-	-	-	-	-	-	-	-	
PS 32-250/150	50x32	258	15	20	97	96.5	96	90	86	73	-	-	-	-	-	-	-	-	-	-	-	
PS 40-160/30	65x40	160	3	4	31.8	-	-	-	29.5	27.5	26.3	21.5	17.5	-	-	-	-	-	-	-	-	
PS 40-160/40	65x40	170	4	5.5	38	-	-	-	36	34	33	28.5	25	20.1	-	-	-	-	-	-	-	
PS 40-200/55	65x40	195	5.5	7.5	46	-	-	-	43.8	41.3	40.1	35	30	-	-	-	-	-	-	-	-	
PS 40-200/75	65x40	209	7.5	10	57	-	-	-	53.6	51.5	50	45	41	36.5	-	-	-	-	-	-	-	
PS 40-250/92	65x40	224	9.2	12.5	64	-	-	-	59	56.5	55	49.5	45	39.8	-	-	-	-	-	-	-	
PS 40-250/110	65x40	230	11	15	72	-	-	-	67.5	65	63.5	57.5	52.2	47	-	-	-	-	-	-	-	
PS 40-250/150	65x40	250	15	20	84.5	-	-	-	79.3	77.3	75.2	70	66	61	-	-	-	-	-	-	-	
PS 40-250/185	65x40	258	18.5	25	90	-	-	-	85.5	82.8	80.7	75.8	70.5	66.5	-	-	-	-	-	-	-	
PS 40-315/185	65x40	260	18.5	25	95	-	-	-	95	93	92.5	87	81	-	-	-	-	-	-	-	-	
PS 40-315/220	65x40	275	22	30	106	-	-	-	106	104	103.5	98	92	-	-	-	-	-	-	-	-	
PS 40-315/300	65x40	290	30	40	120	-	-	-	120	118	117	115	112	-	-	-	-	-	-	-	-	
PS 40-315/370	65x40	322	37	50	144	-	-	-	144	143	142	141	140	132	-	-	-	-	-	-	-	
PS 40-315/450	65x40	340	45	60	160	-	-	-	160	160	159	158	157	152	-	-	-	-	-	-	-	
PS 50-125/22	65x50	123	2.2	3	17	-	-	-	-	15.4	14	12.8	11.5	6.5	-	-	-	-	-	-	-	
PS 50-125/30	65x50	130	3	4	20	-	-	-	-	18.8	18	17	15.6	11	-	-	-	-	-	-	-	
PS 50-125/40	65x50	139	4	5.5	24	-	-	-	-	23.1	23	21.5	20.3	15.8	11.8	-	-	-	-	-	-	
PS 50-160/55	65x50	158	5.5	7.5	32	-	-	-	-	30.6	30	28	26.6	20.5	14.8	-	-	-	-	-	-	
PS 50-160/75	65x50	170	7.5	10	40	-	-	-	-	38	37	36	34.4	29	24	21	-	-	-	-	-	
PS 50-200/92	65x50	195	9.2	12.5	50.5	-	-	-	-	46.8	45	43	40.9	32.5	26.7	-	-	-	-	-	-	
PS 50-200/110	65x50	204	11	15	57.5	-	-	-	-	53.5	52	50	47.5	40	34	29	-	-	-	-	-	
PS 50-200/150	65x50	209	15	20	62	-	-	-	-	58	56.5	54.5	52	44.5	39	35.5	-	-	-	-	-	
PS 50-250/150	65x50	228	15	20	68.5	-	-	-	-	64	63	61.5	59	50	41	-	-	-	-	-	-	
PS 50-250/185	65x50	235	18.5	25	79	-	-	-	-	75.8	74.8	74	71.5	63.5	55.5	47	-	-	-	-	-	
PS 50-250/220	65x50	250	22	30	89.5	-	-	-	-	86	85.3	84	81.5	73.5	63.5	57	-	-	-	-	-	
PS 50-250/300	65x50	258	30	40	95.5	-	-	-	-	92	91.3	90	87.5	79.5	70	63	-	-	-	-	-	
PS 50-315/300	65x50	264	30	40	97	-	-	-	-	94	92	90.5	88	80	72	-	-	-	-	-	-	
PS 50-315/370	65x50	284	37	50	114	-	-	-	-	111	109	107.5	105	97	89	84	-	-	-	-	-	
PS 50-315/450	65x50	306	45	60	132	-	-	-	-	129	127	125.5	123	115	107	102	-	-	-	-	-	
PS 50-315/550	65x50	322	55	75	146	-	-	-	-	143	141	139.5	137	129	121	116	-	-	-	-	-	
PS 50-315/750	65x50	340	75	100	164	-	-	-	-	161	159	157.5	155	147	139	134	-	-	-	-	-	
PS 65-125/40	80x65	122	4	5.5	19	-	-	-	-	17.3	16.8	14.5	13	11.8	-	-	-	-	-	-	-	
PS 65-125/55	80x65	132	5.5	7.5	23	-	-	-	-	21.3	20.9	19	17.5	16.7	13.7	-	-	-	-	-	-	
PS 65-125/75	80x65	142	7.5	10	27	-	-	-	-	26	25.6	24.5	23	22.5	20	18	-	-	-	-	-	
PS 65-160/92	80x65	155	9.2	12.5	33	-	-	-	-	31.5	30	28	27.1	24	21.5	-	-	-	-	-	-	
PS 65-160/110	80x65	164	11	15	36	-	-	-	-	34.5	33	31.5	30.8	28	25.5	-	-	-	-	-	-	
PS 65-160/150	80x65	183	15	20	42	-	-	-	-	41	40	38.5	37.8	35	33	29.5	-	-	-	-	-	
PS 65-200/150	80x65	190	15	20	45	-	-	-	-	45.5	43	41	40.2	36.5	34	-	-	-	-	-	-	
PS 65-200/185	80x65	198	18.5	25	52	-	-	-	-	52.3	51	49	48.2	44.5	42	-	-	-	-	-	-	
PS 65-200/220	80x65	212	22	30	59	-	-	-	-	59.5	58	56	55	52	49.5	44.5	-	-	-	-	-	
PS 65-250/220	80x65	225	22	30	64.8	-	-	-	-	64.7	62	60	58.5	53	50	-	-	-	-	-	-	
PS 65-250/300	80x65	244	30	40	80	-	-	-	-	79.8	77.5	75.5	74.5	70	66	58	-	-	-	-	-	
PS 65-250/370	80x65	258	37	50	92	-	-	-	-	90.5	88.5	87	85	80.5	78	68	-	-	-	-	-	
PS 65-315/450	80x65	262	45	60	102	-	-	-	-	99.2	97	95	94.5	92.4	90	83	-	-	-	-	-	
PS 65-315/550	80x65	290	55	75	122	-	-	-	-	119.2	117.4	115.7	114.5	112.5	110	103	76	-	-	-	-	
PS 65-315/750	80x65	317	75	100	141	-	-	-	-	139.8	137.3	135.6	134.5	132.5	130	122	96	65.5	-	-	-	
PS 65-315/900	80x65	328	90	125	151	-	-	-	-	149.8	147.3	145.6	144.5	142.5	140	132	106	75.5	-	-	-	
PS 80-125/40	100x80	122	4	5.5	17	-	-	-	-	16.5	15.9	14.3	13.5	11.6	10	7.5	-	-	-	-	-	
PS 80-125/55	100x80	132	5.5	7.5	21	-	-	-	-	20.5	20	19	18	16.5	15	12.5	9.5	-	-	-	-	
PS 80-125/75	100x80	142	7.5	10	26	-	-	-	-	25	25	24.5	23.8	22.5	21.5	19.5	16.5	-	-	-	-	

PSM PSB PSBM also available/también disponible/aussi disponible

Performance curve in page/Curva en página/Courbe en page 112-131

TECHNICAL DATA/DATOS TÉCNICOS/DONNÉES TECHNIQUES

50 Hz n=2900 1/min

MODEL MODELO MODÈLE	DN	Impr Φ	Power Potencia Puissance	Q=DELIVERY/CAUDAL/DÉBIT																				
				0	264	396	529	634	793	881	925	969	1057	1233	1322	1586	1762	2203	2643	2907	3524	4405		
				H=Head/Altura/Hauteur(m)																				
				0	60	90	100	150	200	240	300	3333	3500	3667	4000	4667	5000	6000	6667	8333	10000	11000	13333	16667
				0	60	90	100	150	200	240	300	3333	3500	3667	4000	4667	5000	6000	6667	8333	10000	11000	13333	16667
PS 80-160/110	100x80	160	11	15	28	27	27.3	24.5	21.1	16	-	-	-	-	-	-	-	-	-	-	-	-		
PS 80-160/150	100x80	168	15	20	34	32.6	32.5	30.2	27	22.1	18.5	16.7	-	-	-	-	-	-	-	-	-	-		
PS 80-160/185	100x80	180	18.5	25	39	38.5	38	36.7	33.6	28.8	25.3	23.5	-	-	-	-	-	-	-	-	-	-		
PS 80-160/220	100x80	190	22	30	44	43.5	43	41.7	38.6	33.8	30.3	28.5	-	-	-	-	-	-	-	-	-	-		
PS 80-200/220	100x80	190	22	30	48	47.7	47.5	43.5	39.2	32.5	27.2	24.5	-	-	-	-	-	-	-	-	-	-		
PS 80-200/300	100x80	215	30	40	60	59.7	59.5	57	53.1	47	42.7	40.5	-	-	-	-	-	-	-	-	-	-		
PS 80-250/370	100x80	226	37	50	71.5	70.9	70.5	65.5	59.3	51	43.2	38.												



PS4 n = 1450 rpm

End suction centrifugal pump Bomba centrífuga de succión final Pompe centrifuge aspiration finale



PS4



PSM4



PSB4

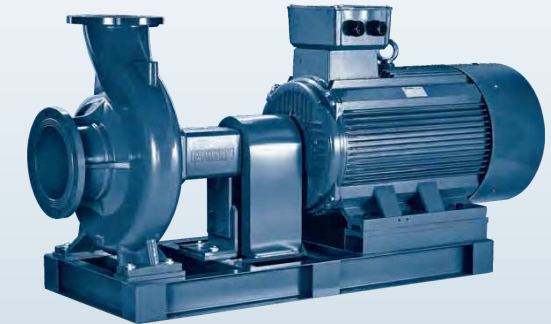

PSBM4

NEW/NUEVO/NOUVEAU

DESCRIPTION/DESCRIPCIONES/DESCRIPTION

- ◆ Complete range with a full series of end suction pumps
 - ◆ Original design by PURITY (Patent no.201530478502.0)
 - ◆ Outstanding reliability for operation in any application
 - ◆ YE3 high efficient motor, with protection IP55 class F
 - ◆ Pump case with anti-corrosive coating
 - ◆ Customize casting logo on the bearing house as request
 - ◆ Quality NSK bearing, wear resistance mechanical seal
- ◆ Gama completa con una serie completa de bombas
 - ◆ Diseño original de PURITY (Patente no.201530478502.0)
 - ◆ Excelente fiabilidad para cualquier aplicación
 - ◆ Motor de eficiencia YE3 con Protección IP55 clase F
 - ◆ Cuerpo de bomba con tratamiento anti-corrosión
 - ◆ Personalizar el logotipo de fundición en la caja como solicitud
 - ◆ Rodamiento de marca NSK y cierre mecánico personalizado
- ◆ Gamme complète avec une série complète de pompes
 - ◆ Design original par PURITY (Brevet no.201530478502.0)
 - ◆ Fiabilité exceptionnelle pour n'importe quelle application
 - ◆ Moteur haute efficacité YE3, avec protection IP55 classe F
 - ◆ Boîtier de pompe avec revêtement anti-corrosif
 - ◆ Personnalisez le logo de coulée sur le palier comme demande
 - ◆ Roulement NSK qualité, joint mécanique de résistance à l'usure

APPLICATIONS/APLICACIONES/APPLICATIONS

- ◆ The impressive range end-suction pumps is compatible with an array of application areas, including water intake, heating, industrial pressure boosting, industrial liquid transfer, air-conditioning, district cooling, irrigation, fire fighting and many more.
- ◆ La impresionante gama de bombas de succión final es compatible con una variedad de áreas de aplicación, que incluyen la toma de agua, calefacción, aumento de la presión industrial, transferencia de líquido industrial, aire acondicionado, refrigeración urbana, riego, extinción de incendios y muchos más.
- ◆ La gamme impressionnante de pompes à aspiration finale est compatible avec un large éventail de domaines d'application, notamment prise d'eau, chauffage, surpression industrielle, transfert de liquide industriel, climatisation, refroidissement urbain, l'irrigation, lutte contre l'incendie et bien d'autres.

USING LIMITS/LÍMITES UTILIZACIÓN/UTILISATION LIMITES

- ◆ Liquid temperature between -10°C and +120°C
- ◆ Ambient temperature between -10°C and +50°C
- ◆ Max. working pressure **16 bar**
- ◆ Continuous service **S1**
- ◆ Temperatura del líquido de -10 °C hasta +120 °C
- ◆ Temperatura ambiente de -10 °C hasta +50 °C
- ◆ Presión máxima en el cuerpo de la bomba **16 bar**
- ◆ Funcionamiento continuo **S1**
- ◆ Température du liquide entre -10 °C et +120 °C
- ◆ Température ambiante entre -10 °C et +50 °C
- ◆ Max. pression de service **16 bar**
- ◆ Service continu **S1**

MODEL CODE/CÓDIGO MODELO/CODE MODÈLE

For example/ Por ejemplo/ Par exemple

PS4 (PSM4) 100 - 250 / 75

- ◆ **75**=Rated power(kw)x10
Potencia nominal(kw)x10
Puissance nominale (kw) x10
- ◆ **250**=Nominal impeller size(mm)
Tamaño nominal del impulsor (mm)
Taille nominale de la roue (mm)
- ◆ **100**=Discharge/Descarga/Décharge(mm)
- ◆ **PSM4**=End suction pump with motor&base 1450 rpm
Bomba con motor y base 1450 rpm
Pompe avec moteur et base 1450 rpm
- ◆ **PSBM4**=End suction pump with motor&base 1450 rpm
(in type B bearing house)
Bomba con motor y base 1450 rpm
(en soporte de rodamiento tipo B)
Pompe avec moteur et base 1450 rpm
(dans une maison de roulement de type B)
- ◆ **PS4**=End suction pump only 1450 rpm
Solo bomba 1450 rpm
Pompe uniquement 1450 rpm
- ◆ **PSB4**=End suction pump only 1450 rpm
(in type B bearing house)
Solo bomba 1450 rpm
(en soporte de rodamiento tipo B)
Pompe uniquement 1450 rpm
(dans une maison de roulement de type B)

TECHNICAL SHEET/HOJA TÉCNICA/FICHE TECHNIQUE

Model/Modelo/Modèle	PS4	
Capacity/Caudal/Débit	0-1500	m ³ /h
Head/Altura/Hauteur	0-72	m
DN	65-250	mm
Speed/Velocidad/Vitesse	1450	rpm
T max	120	°C
Power/Potencia/Puiss.	1.1-250	kW
Casing/Cuerpo/Corps	Grey cast iron Hierro fundido gris Fonte grise	
Impeller/Impulsor/Roue	Cast iron/AISI 304/Brass Hierro fundido /Inox 304/Bronce Fonte /Inox 304 /Laiton	
Shaft/Eje/Arbre	45# steel/AISI304 45 # acero/Inox304 45 # acier/Inox304	
Shaft seal/Sello/Scellé	Mechanical Seal Sello mecánico Garniture mécanique	
Bearing/Rodamiento/Palier	Grease lubrication rolling bearing Rodamientos lubricación con grasa Roulement lubrification à la graisse	

MATERIAL DESCRIPTION/DESCRIPCIÓN DE MATERIAL/DESCRIPTION DU MATÉRIEL

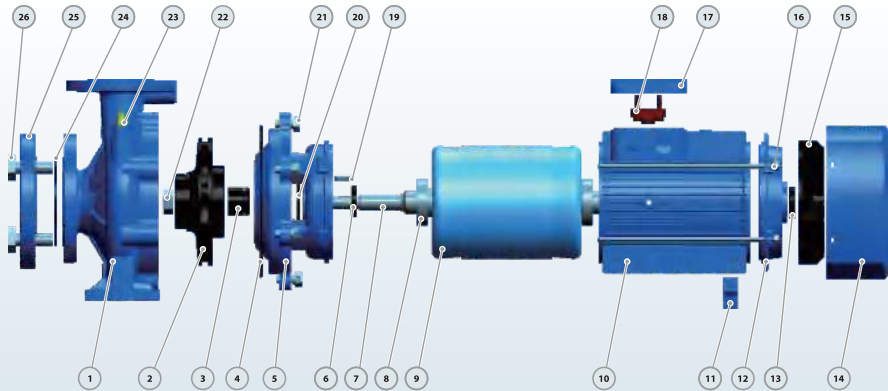

No.	Description Descripción Description	Material Material Matériel	No.	Description Descripción Description	Material Material Matériel
1	Pump Case Cuerpo de Bomba Boîtier de pompe	Cast iron Fundición Fonte	10	Motor Case Cuerpo de Motor Boîtier du moteur	Aluminum Aluminio Aluminium
2	Impeller Impulsor Roue	SS304/Cast iron Inox304/Fundición Inox304/Fonte	11	Support Foot Soporte Pie Pied de support	Plastic Plástico Plastique
3	Mechanical Seal Cierre Mecánico Garniture mécanique	SiC/Carbon/SS304 SiC/Grafito/Inox304 SiC/Carbon/Inox304	12	Back Cover Tapa Trasera Quatrième de couverture	Cast iron Fundición Fonte
4	O-ring Junta Tórica Joint torique	Rubber Caucho Caoutchouc	13	Reinforced Seal Sello Reforzado Joint renforcé	Rubber Caucho Caoutchouc
5	Connection Conexión Lien	Cast iron Fundición Fonte	14	Fan Cover Tapa Ventilador Couverture de ventilateur	Aluminum Aluminio Aluminium
6	Reinforced Seal Sello Reforzado Joint renforcé	Rubber Caucho Caoutchouc	15	Fan Ventilador Ventilateur	Plastic Plástico Plastique
7	Shaft Eje Arbre	SS304/45# Steel Inox 304/45# Hierro Inox304/45 #Acier	16	Through Bolt Caja de Bornas Traversant le boulon	Steel Acero Acier
8	Bearing Rodamiento Palier	Ball Bearing Bola Rodamiento Roulement à billes	17	Terminal Box Caja de Bornas Boîte à bornes	Aluminum Aluminio Aluminium
9	Wound Stator/Rotor Estator / Rotor Stator / Rotor blessure	Silicon Steel/Copper Acero al Silicio/Cobre Acier au silicium/Cuivre	18	Terminal Board Tablero de Bornas Terminal Board	Plastic Plástico Plastique

MATERIAL DESCRIPTION/DESCRIPCIÓN DE MATERIAL/DESCRIPTION DU MATÉRIEL

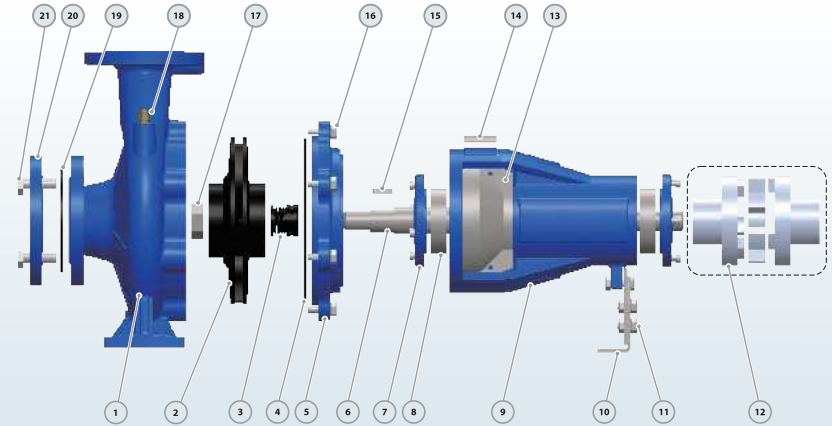

No.	Description Descripción Description	Material Material Matériel	No.	Description Descripción Description	Material Material Matériel
1	Pump Case Cuerpo de Bomba Boîtier de pompe	Cast iron Fundición Fonte	8	Bearing Rodamiento Palier	Ball Bearing Bola Rodamiento Roulement à billes
2	Impeller Impulsor Roue	SS304/Cast iron Inox304/Fundición Inox304/Fonte	9	Support Case Cuerpo Soporte Cas de support	Cast iron Fundición Fonte
3	Mechanical Seal Cierre Mecánico Garniture mécanique	SiC/Carbon/SS304 SiC/Grafito/Inox304 SiC/Carbon/Inox304	10	Support Foot Soporte Pie Pied de support	Iron Hierro Le fer
4	O-ring Junta Tórica Joint torique	Rubber Caucho Caoutchouc	11	Foot Bolt Perno Boulon de pied	Steel Acero Acier
5	Connection Conexión Lien	Cast iron Fundición Fonte	12	Coupling(Optional) Unión(Opcional) Accouplement (facultatif)	Steel Acero Acier
6	Shaft Eje Arbre	SS304/45# Steel Inox304/45# Hierro Acier Inox304/45 #	13	Case Cover Tapa Cuerpo Housse de protection	SS304 Inox304 Inox304
7	Bearing Cover Tapa Rodamiento Couvercle de palier	Cast iron Fundición Fonte	14	Nameplate Letrero Plaque signalétique	Aluminum Aluminio Aluminium
			15	Impeller Key Chaveta Impulsor Clé de roue	Iron Hierro Le fer
			16	Connection Bolt Perno Boulon de connexion	Steel Acero Acier
			17	Impeller Nut Tuerca de Impulsor Écrou de roue	Galvanized Steel Acero Galvanizado Acier Galvanisé
			18	Release Valve Tapón Cebado Soupape de décharge	Brass Bronce Laiton
			19	Gasket Empaque Joint	Rubber Caucho Caoutchouc
			20	Counter Flange Contra Brida Contre bride	Galvanized Cast iron Fundición Galvanizado Fonte Galvanisée
			21	Flange Bolt Perno de Brida Boulon à bride	Steel Acero Acier

DIMENSIONS AND WEIGHT/DIMENSIONES Y PESOS/DIMENSIONS ET POIDS

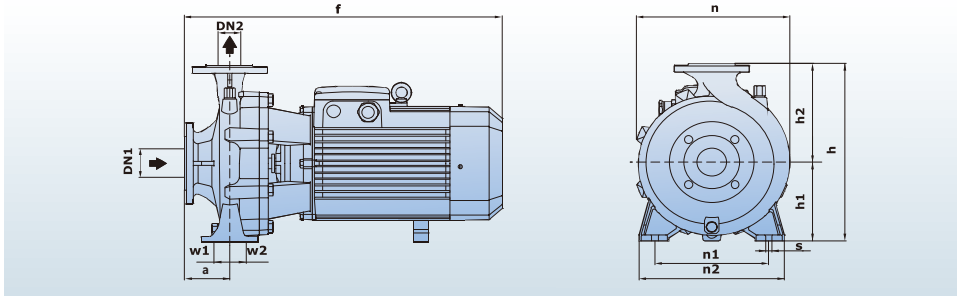

MODEL MODELO MODÈLE	DIMENSIONS/DIMENSIONES/DIMENSIONS mm														kg 3~				
	DN1	DN2	a	f	h	h1	h2	n	n1	n2	w1	w2	s	3~					
PST 32-125/7	50	32	80	435	255	114	141	202	140	190	35	35	15	24					
PST 32-125/11			80	435	255	114	141	202	140	190				25					
PST 32-160/15			83	435	295	133	162	245	190	245				34					
PST 32-160/22			83	470	295	133	162	245	190	245				39					
PST 32-160/30			82	490	342	161	181	265	190	240				50					
PST 32-200/30			82	490	342	161	181	265	190	240				52					
PST 32-200/40			82	490	342	161	181	265	190	240				53					
PST 32-250/55			88	590	405	186	219	333	250	328				66					
PST 32-250/75			88	590	405	186	219	333	250	328				73					
PST 32-250/92			88	590	405	186	219	333	250	328				80					
PST 32-250/110	88	590	405	186	219	333	250	328	95										
PST 32-250/150	94	712	415	186	229	327	250	327	125										
PST 32-250/55D-75D	160	610	362	162	200	330	216	280	73/80										
PST 40-125/11	50	40	82	440	260	116	144	220	160	212	37	37	15	27					
PST 40-125/15			82	440	260	116	144	220	160	212				29					
PST 40-125/22			80	490	305	135	170	250	190	241				34					
PST 40-160/30			80	490	305	135	170	250	190	241				48					
PST 40-160/40			102	560	345	162	193	282	214	267				50					
PST 40-200/55-75			102	560	345	162	193	282	214	267				66/73					
PST 40-250/92			94	712	415	186	229	327	250	327				100					
PST 40-250/110			94	712	415	186	229	327	250	327				116					
PST 40-250/150			94	712	415	186	229	327	250	327				146					
PST 40-250/185			94	712	415	186	229	327	250	327				155					
PST 50-125/22	50	50	102	525	305	135	170	263	190	245	37	37	15	41					
PST 50-125/30			102	525	305	135	170	263	190	245				50					
PST 50-125/40			110	560	348	164	193	270	212	262				52					
PST 50-160/55-75			110	560	348	164	193	270	212	262				64/71					
PST 50-200/92			104	722	392	186	206	307	232	310				90					
PST 50-200/110			104	722	392	186	206	307	232	310				106					
PST 50-200/150			102	720	416	186	230	330	250	327				145					
PST 50-250/150-185-220			102	720	416	186	230	330	250	327				148/153/183					
PST 65-125/40			80	65	104	580	345	162	193	275				212	280	49	49	16	56
PST 65-125/55-75					104	580	345	162	193	275				212	280				68/74
PST 65-160/92	110	730			425	186	239	330	232	309	90								
PST 65-160/110	110	730			425	186	239	330	232	309	106								
PST 65-160/150	111	740			425	186	239	330	232	309	134								
PST 65-200/150-185-220	111	740			425	186	239	330	232	309	140/145/185								
PST 80-125/40	100	80			117	750	357	163	194	330	212	280	55	55	16				56
PST 80-125/55-75					117	750	357	163	194	330	212	280							68/74
PST 80-160/110					88	750	435	186	250	330	255	332							113
PST 80-160/150					88	750	435	186	250	330	255	332							143/150/183
PST 80-160/150-185-220			88	750	435	186	250	330	255	332	143/150/183								
PST 100-160/150-185-220			125	100	130	765	435	186	250	345	262	340				55	55	16	143/150/183

DIMENSIONS AND WEIGHT/DIMENSIONES Y PESOS/DIMENSIONS ET POIDS

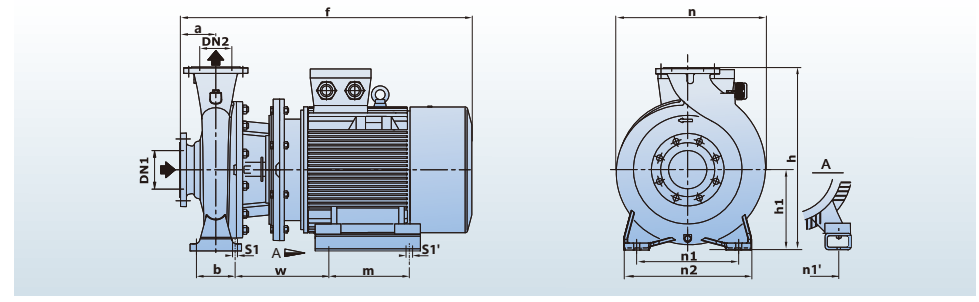

MODEL MODELO MODÈLE	DIMENSIONS/DIMENSIONES/DIMENSIONS mm																kg 3~
	DN1	DN2	a	f	h	h1	n	n1	n1'	n2	b	l	w	m	s1	s1'	
PST 65-250/220	80	65	116	870	420	180	369	280	279	360	120	237	241	18	15	214	
PST 65-250/300	80	65	116	990	420	180	369	280	318	360	120	278	305	18	18	265	
PST 65-250/370	80	65	116	990	420	180	369	280	318	360	120	278	305	18	18	285	
PST 65-315/450	80	65	125	1069	505	225	440	280	356	360	120	324	311	18	18	371	
PST 65-315/550	80	65	125	1160	505	225	440	280	406	360	120	373	349	18	24	450	
PST 65-315/750	80	65	125	1232	505	225	440	280	457	360	120	395	368	18	24	582	
PST 65-315/900	80	65	125	1283	505	225	440	280	457	360	120	395	419	18	24	617	
PST 80-200/220	100	80	125	880	460	250	360	280	279	345	95	251	241	14	15	211	
PST 80-200/300	100	80	125	950	460	250	360	280	318	345	95	242	305	14	18	262	
PST 80-250/370	100	80	125	950	535	250	410	315	318	400	120	229	305	18	18	289	
PST 80-250/450	100	80	125	980	535	250	410	315	356	400	120	235	311	18	18	362	
PST 80-250/550	100	80	125	1160	535	250	410	315	406	400	120	373	349	18	24	441	
PST 80-315/450	100	80	125	1069	565	250	452	315	356	400	120	324	311	18	18	381	
PST 80-315/550	100	80	125	1160	565	250	452	315	406	400	120	373	349	18	24	460	
PST 80-315/750	100	80	125	1232	565	250	452	315	457	400	120	395	368	18	24	592	
PST 80-315/900	100	80	125	1283	565	250	452	315	457	400	120	395	419	18	24	627	
PST 100-200/220	125	100	125	910	530	225	422	280	279	360	120	268	241	18	15	216	
PST 100-200/300	125	100	125	1025	530	225	422	280	318	360	120	304	305	18	18	267	
PST 100-200/370	125	100	125	1025	530	225	422	280	318	360	120	304	305	18	18	287	
PST 100-250/450	125	100	140	1000	580	250	450	315	356	400	120	240	311	18	18	366	
PST 100-250/550	125	100	140	1180	580	250	450	315	406	400	120	378	349	18	24	445	
PST 100-250/750	125	100	140	1250	580	250	450	315	457	400	120	398	368	18	24	577	
PST 100-250/900	125	100	140	1300	580	250	422	315	457	400	120	397	419	18	24	612	
PST 100-315/750	125	100	140	1262	625	250	480	315	457	400	120	410	368	19	24	591	
PST 100-315/900	125	100	140	1313	625	250	480	315	457	400	120	410	419	19	24	626	
PST 100-315/1100	125	100	140	1474	625	250	480	315	508	400	120	436	406	19	28	972	
PST 100-315/1320	125	100	140	1584	625	250	480	315	508	400	120	436	457	19	28	1087	
PST 100-315/1600	125	100	140	1584	625	250	480	315	508	400	120	436	508	19	28	1125	
PST 125-200/450	150	125	140	1099	565	250	422	315	356	400	120	339	311	19	18	378	
PST 125-200/550	150	125	140	1190	565	250	422	315	406	400	120	388	349	19	24	457	
PST 125-200/750	150	125	140	1262	565	250	422	315	457	400	120	410	368	19	24	589	
PST 125-250/550	150	125	140	1190	605	250	500	315	406	400	120	388	349	19	24	457	
PST 125-250/750	150	125	140	1262	605	250	500	315	457	400	120	410	368	19	24	589	
PST 125-250/900	150	125	140	1313	605	250	500	315	457	400	120	410	419	19	24	624	
PST4 65-250/30	80	65	116	606	420	180	369	280	160	360	120	147	140	18	12	71	
PST4 65-250/40	80	65	116	594	420	180	369	280	190	360	120	154	140	18	12	87	
PST4 65-250/55	80	65	116	638	420	180	369	280	216	360	120	193	140	18	12	98	
PST4 65-315/40	80	65	125	644	505	225	440	280	190	360	120	195	140	18	12	101	
PST4 65-315/55-75	80	65	125	688	505	225	440	280	216	360	120	234	140	18	12	112/130	
PST4 65-315/110-150	80	65	125	858	505	225	440	280	254	360	120	283	210	18	15	163/185	
PST4 80-200/30	100	80	125	606	460	250	360	280	160	345	95	151	140	14	12	68	
PST4 80-200/40	100	80	125	594	460	250	360	280	190	345	95	158	140	14	12	84	

DIMENSIONS AND WEIGHT/DIMENSIONES Y PESOS/DIMENSIONS ET POIDS

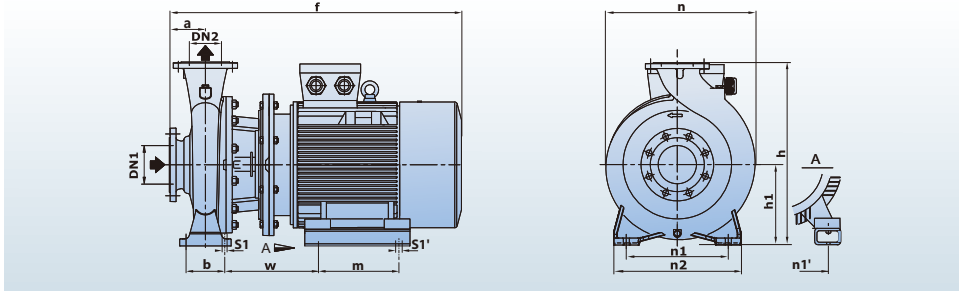

MODEL MODELO MODÈLE	DIMENSIONS/DIMENSIONES/DIMENSIONS mm													kg 3~		
	DN1	DN2	a	f	h	h1	n	n1	n1'	n2	b	w	m		s1	s1'
PST4 80-250/55	100	80	125	638	535	250	410	315	216	400	120	184	140	18	12	102
PST4 80-250/75	100	80	125	638	535	250	410	315	216	400	120	184	140	18	12	120
PST4 80-250/110	100	80	125	808	535	250	410	315	254	400	120	233	210	18	15	154
PST4 80-315/55-75	100	80	125	688	565	250	452	315	216	400	120	234	140	18	12	122/140
PST4 80-315/110-150	100	80	125	858	565	250	452	315	254	400	120	283	210	18	15	173/195
PST4 80-400/185	100	80	125	902	635	280	536	315	254	400	120	283	254	18	15	251
PST4 80-400/220	100	80	125	938	635	280	536	315	279	400	120	296	241	18	15	271
PST4 80-400/300	100	80	125	1029	635	280	536	315	318	400	120	308	305	18	18	334
PST4 100-200/40	125	100	125	644	530	225	422	280	190	360	120	195	140	18	12	89
PST4 100-200/55-75	125	100	125	688	530	225	422	280	216	360	120	234	140	18	12	100/118
PST4 100-250/55-75	125	100	140	688	580	250	450	315	216	400	120	219	140	18	12	107/125
PST4 100-250/110-150	125	100	140	858	580	250	450	315	254	400	120	268	210	18	15	158/180
PST4 100-315/150	125	100	140	888	625	250	480	315	254	400	120	298	210	19	15	194
PST4 100-315/185	125	100	140	932	625	250	480	315	254	400	120	298	254	19	15	234
PST4 100-315/220	125	100	140	968	625	250	480	315	279	400	120	311	241	19	15	254
PST4 100-315/300	125	100	140	1059	625	250	480	315	318	400	120	323	305	19	18	317
PST4 100-400/300-370	125	100	140	1059	655	280	548	400	318	500	150	308	305	23	18	348/391
PST4 100-400/450	125	100	140	1099	655	280	548	400	356	500	150	324	311	23	18	418
PST4 125-200/55-75	150	125	140	718	565	250	422	315	216	400	120	249	140	19	12	107/125
PST4 125-200/110	150	125	140	888	565	250	422	315	254	400	120	298	210	19	15	170
PST4 125-250/75	150	125	140	718	605	250	500	315	216	400	120	249	140	19	12	137
PST4 125-250/110-150	150	125	140	888	605	250	500	315	254	400	120	298	210	19	15	170/192
PST4 125-250/185	150	125	140	932	605	250	500	315	254	400	120	298	254	19	15	232
PST4 125-315/185	150	125	140	932	635	280	525	400	254	500	150	283	254	23	15	252
PST4 125-315/220	150	125	140	968	635	280	525	400	279	500	150	296	241	23	15	272
PST4 125-315/300-370	150	125	140	1059	635	280	525	400	318	500	150	308	305	23	18	335/378
PST4 150-200/110-150	200	150	160	928	680	280	435	450	254	550	150	303	210	23	15	197/219
PST4 150-200/185	200	150	160	972	680	280	435	450	254	550	150	303	254	23	15	259
PST4 150-200/220	200	150	160	1008	680	280	435	450	279	550	150	316	241	23	15	279
PST4 150-250/150	200	150	160	928	715	280	510	450	254	550	150	303	210	23	15	226
PST4 150-250/185	200	150	160	972	715	280	510	450	254	550	150	303	254	23	15	266
PST4 150-250/220	200	150	160	1008	715	280	510	450	279	550	150	316	241	23	15	286
PST4 150-250/300	200	150	160	1099	715	280	510	450	318	550	150	328	305	23	18	349
PST4 150-315/370	200	150	160	1099	740	280	548	450	318	550	150	328	305	23	18	395
PST4 150-315/450	200	150	160	1139	740	280	548	450	356	550	150	344	311	23	18	422
PST4 150-315/550	200	150	160	1230	740	280	548	450	406	550	150	393	349	23	24	511
PST4 150-315/750	200	150	160	1302	740	280	548	450	457	550	150	415	368	23	24	639
PST4 150-400/550	200	150	160	1230	765	315	623	450	406	550	150	393	349	23	24	532
PST4 150-400/750	200	150	160	1302	765	315	623	450	457	550	150	415	368	23	24	660
PST4 150-400/900	200	150	160	1353	765	315	623	450	457	550	150	415	419	23	24	752
PST4 150-400/1100	200	150	160	1514	765	315	623	450	508	550	150	441	406	23	28	1053
PST4 150-400/1320	200	150	160	1624	765	315	623	450	508	550	150	441	457	23	28	1147

DIMENSIONS AND WEIGHT/DIMENSIONES Y PESOS/DIMENSIONS ET POIDS

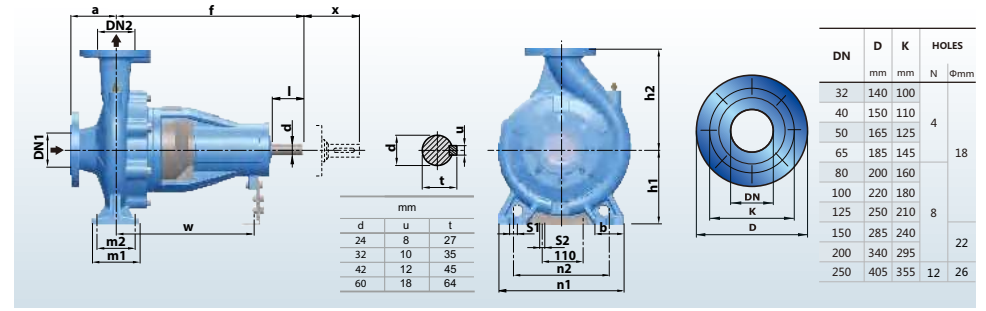

MODEL MODELO MODÈLE	DIMENSIONS/DIMENSIONES/DIMENSIONS mm																kg 3~	
	DN1	DN2	a	f	h1	h2	b	m1	m2	n1	n2	s1	s2	w	x	d		l
32-160	50	32	80	360	132	160	55	95	70	240	190	14	14	260	100	24	50	31
32-200	50	32	80	360	160	180	55	95	70	240	190	14	14	260	100	24	50	35
32-250	50	32	80	360	160	180	55	95	70	240	190	14	14	260	100	24	50	35
40-160	65	40	80	360	132	160	50	100	70	240	190	14	14	260	100	24	50	35
40-200	65	40	100	360	160	180	55	100	70	265	212	14	14	260	100	24	50	38
40-250	65	40	100	360	180	225	65	125	95	320	250	14	14	260	100	24	50	58
40-315	65	40	125	500	200	160	65	125	95	345	280	14	14	370	140	32	80	82
50-125	65	50	100	360	132	180	50	100	70	240	190	14	14	260	100	24	50	30
50-160	65	50	100	360	160	200	55	100	70	265	212	14	14	260	100	24	50	35
50-200	65	50	100	360	160	225	50	100	70	265	212	14	14	260	100	24	50	45
50-250	65	50	100	360	180	180	65	125	95	320	250	14	14	260	100	24	50	50
50-315	65	50	125	500	225	280	65	125	95	345	280	14	14	370	140	32	80	90
65-125	80	65	100	360	160	250	65	125	95	280	212	14	14	260	100	24	50	42
65-160	80	65	100	360	160	200	65	125	95	280	212	14	14	260	100	24	50	45
65-200	80	65	100	360	180	225	65	125	95	320	250	14	14	260	140	24	50	50
65-250	80	65	100	470	200	250	80	160	120	360	280	18	14	340	140	32	80	71
65-315	80	65	125	470	225	280	80	160	120	360	280	18	14	340	140	32	80	98
80-125	100	80	100	360	180	225	65	125	95	320	250	14	14	260	140	24	50	46
80-160	100	80	100	360	180	225	65	125	95	345	250	14	14	260	140	24	50	48
80-200	100	80	100	470	200	250	65	125	95	345	280	14	14	340	140	32	80	65
80-250	100	80	100	470	200	280	80	160	120	400	315	18	14	340	140	32	80	79
80-315	100	80	125	470	250	315	80	160	120	400	315	18	14	340	140	24	50	118
80-400	100	80	125	540	280	355	80	160	120	400	315	18	14	340	140	32	80	150
100-160	125	100	125	360	200	280	80	160	120	360	280	18	14	260	140	32	80	55
100-200	125	100	125	470	200	280	80	160	120	360	280	18	14	340	140	32	80	75
100-250	125	100	125	470	225	280	80	160	120	400	315	18	14	340	140	32	80	88
100-315	125	100	140	470	250	315	80	160	120	400	315	19	14	340	140	32	80	116
100-400	125	100	140	530	280	355	100	200	150	500	400	23	14	370	140	42	110	178
125-200	150	125	140	470	250	315	80	160	120	400	315	19	14	340	140	32	80	112
125-250	150	125	140	470	250	355	80	160	120	400	315	19	14	340	140	32	80	112
125-250H	150	125	140	530	250	355	80	160	120	400	315	19	14	370	140	42	110	140
125-315	150	125	140	530	280	355	100	200	150	500	400	23	14	370	140	42	110	152
125-400	150	125	140	530	315	400	100	200	150	500	400	23	14	370	140	42	110	200
150-200	200	150	160	470	280	400	100	200	150	550	450	23	14	370	140	32	80	166
150-250	200	150	160	530	280													



YE3

Electric motor TEFC type
Motor eléctrico tipo TEFC
Moteur électrique type TEFC



NEW/NUEVO/NOUVEAU

DESCRIPTION/DESCRIPCIONES/DESCRIPTION

- ◆ Design according to IEC60034 standard
 - ◆ TOTAL ENCLOSED FAN COOLING TYPE motor
 - ◆ YE3 high efficient motor
 - ◆ Protection IP55 class F
 - ◆ Quality NSK bearing
 - ◆ Continuous duty S1
 - ◆ Reliable used for fire fighting system etc.
 - ◆ Ambient temperature up to +50°C
 - ◆ Cooling type : IC411
- ◆ Diseño de acuerdo con el estándar IEC60034
 - ◆ TOTAL DE VENTILADOR CERRADO TIPO motor
 - ◆ Motor de alta eficiencia YE3
 - ◆ Protección IP55 clase F
 - ◆ Rodamiento NSK de calidad
 - ◆ Servicio continuo S1
 - ◆ Fiable utilizado para el sistema de contra incendios, etc.
 - ◆ Temperatura ambiente hasta + 50 °C
 - ◆ Tipo de enfriamiento: IC411
- ◆ Conception selon la norme IEC60034
 - ◆ TOTAL REFOUILLISSEMENT PAR VENTILATEUR MOTEUR TYPE
 - ◆ Moteur haute efficacité YE3
 - ◆ Protection IP55 classe F
 - ◆ Roulement NSK de qualité
 - ◆ Service continu S1
 - ◆ Fiable utilisé pour le système de lutte contre l'incendie, etc.
 - ◆ Température ambiante jusqu'à + 50 °C
 - ◆ Type de refroidissement: IC411

MODEL CODE/CÓDIGO MODELO/CODE MODÈLE

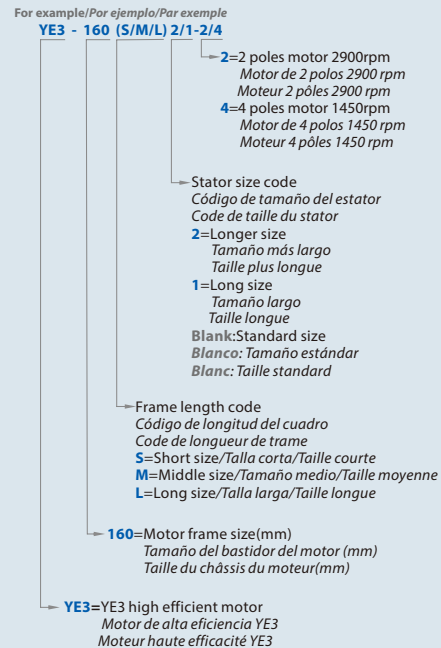

TECHNICAL DATA/DATOS TÉCNICOS/DONNÉES TECHNIQUES

50 Hz n=2900 1/min

MODEL MODELO MODÈLE	Power Potencia Puissance		RPM	η			cos Φ	A			Nm	Ts/Tn	Tmax/Tn	Is/In	dB(A)	Kgs	
	kw	hp		1/min	%	75%		50%	380V	400V							415V
	YE3-801-2	0.75		1	2880	80.7		80.7	79.1	0.82							1.72
YE3-802-2	1.1	1.5	2880	82.7	82.7	81	0.83	2.43	2.31	2.23	3.65	2.2	2.3	7.3	73	19.5	
YE3-90S-2	1.5	2	2895	84.2	84.2	82.5	0.84	3.22	3.06	2.95	4.95	2.2	2.3	7.6	76	23.3	
YE3-90L-2	2.2	3	2895	85.9	85.9	84.2	0.85	4.58	4.35	4.19	7.26	2.2	2.3	7.6	77	27.1	
YE3-100L-2	3	4	2895	87.1	87.1	85.4	0.87	6.02	5.71	5.51	9.9	2.2	2.3	7.8	79	38.8	
YE3-112M-2	4	5.5	2905	88.1	88.1	86.3	0.88	7.84	7.45	7.18	13.1	2.2	2.3	8.3	80	48.3	
YE3-132S1-2	5.5	7.5	2930	89.2	89.2	87.4	0.88	10.6	10.1	9.75	17.9	2	2.3	8.3	83	55.1	
YE3-132S2-2	7.5	10	2930	90.1	90.1	88.3	0.88	14.4	13.7	13.2	24.4	2	2.3	7.9	84	69.2	
YE3-160M1-2	11	15	2945	91.2	91.2	89.4	0.89	20.6	19.6	18.9	35.7	2	2.3	8.1	87	113	
YE3-160M2-2	15	20	2945	91.9	91.9	90.1	0.89	27.9	26.5	25.5	48.6	2	2.3	8.1	87	123	
YE3-160L-2	18.5	25	2940	92.4	92.4	90.6	0.89	34.2	32.5	31.3	60.1	2	2.3	8.2	90	142	
YE3-180M-2	22	30	2955	92.7	92.7	90.8	0.89	40.5	38.5	37.1	71.1	2	2.3	8.2	90	182	
YE3-200L1-2	30	40	2960	93.3	93.3	91.4	0.89	54.9	52.1	50.3	96.8	2	2.3	7.6	91	246	
YE3-200L2-2	37	50	2960	93.7	93.7	91.8	0.89	67.4	64	61.7	119.4	2	2.3	7.6	91	265	
YE3-225M-2	45	60	2965	94	94	92.1	0.9	80.8	76.8	74	144.9	2	2.3	7.7	93	323	
YE3-250M-2	55	75	2970	94.3	94.3	92.4	0.9	98.5	93.5	90.2	176.9	2	2.3	7.7	93	413	
YE3-280S-2	75	100	2975	94.7	94.7	92.8	0.9	134	127	122	240.8	1.8	2.3	7.1	94	546	
YE3-280M-2	90	125	2975	95	95	93.1	0.9	160	152	146	288.9	1.8	2.3	7.1	94	569	
YE3-315S-2	110	150	2978	95.2	95.2	93.3	0.9	195	185	179	352.8	1.8	2.3	7.1	94	897	
YE3-315M-2	132	180	2978	95.4	95.4	93.5	0.9	234	222	214	423.3	1.8	2.3	7.1	95	1029	
YE3-315L1-2	160	220	2980	95.6	95.6	93.7	0.91	279	265	256	512.8	1.8	2.3	7.2	95	1067	
YE3-315L2-2	200	270	2980	95.8	95.8	93.9	0.91	349	331	319	640.9	1.8	2.2	7.2	95	1194	
YE3-355M-2	250	340	2982	95.8	95.8	93.9	0.91	436	414	399	800.6	1.6	2.2	7.2	103	1685	
YE3-355L-2	315	430	2982	95.8	95.8	93.9	0.91	549	522	503	1009	1.6	2.2	7.2	103	1734	

50 Hz n=1450 1/min

MODEL MODELO MODÈLE	Power Potencia Puissance		RPM	η			cos Φ	A			Nm	Ts/Tn	Tmax/Tn	Is/In	dB(A)	Kgs	
	kw	hp		1/min	%	75%		50%	380V	400V							415V
	YE3-801-4	0.55		0.75	1400	80.8		80.8	79.2	0.75							1.38
YE3-802-4	0.75	1	1420	82.5	82.5	80.9	0.75	1.84	1.75	1.69	5.04	2.3	2.3	6.6	63	18.4	
YE3-90S-4	1.1	1.5	1445	84.1	84.1	82.4	0.76	2.61	2.48	2.39	7.27	2.3	2.3	6.8	66	24.2	
YE3-90L-4	1.5	2	1445	85.3	85.3	83.6	0.77	3.47	3.3	3.18	9.91	2.3	2.3	7	66	29.7	
YE3-100L1-4	2.2	3	1450	86.7	86.7	85	0.81	4.76	4.52	4.36	14.6	2.3	2.3	7.6	68	41.5	
YE3-100L2-4	3	4	1450	87.7	87.7	85.9	0.82	6.34	6.02	5.8	20	2.3	2.3	7.6	68	46	
YE3-112M-4	4	5.5	1450	88.6	88.6	86.8	0.82	8.37	7.95	7.66	26.5	2.2	2.3	7.8	72	63.2	
YE3-132S-4	5.5	7.5	1460	89.6	89.6	87.8	0.83	11.2	10.7	10.3	36	2	2.3	7.9	74	71.2	
YE3-132M-4	7.5	10	1460	90.4	90.4	88.6	0.84	15	14.3	13.7	49.1	2	2.3	7.5	77	85.1	
YE3-160M-4	11	15	1465	91.4	91.4	89.6	0.85	21.5	20.4	19.7	71.7	2.2	2.3	7.7	78	121	
YE3-160L-4	15	20	1465	92.1	92.1	90.3	0.86	28.8	27.3	26.3	97.8	2.2	2.3	7.8	82	142	
YE3-180M-4	18.5	25	1470	92.6	92.6	90.7	0.86	35.3	33.5	32.3	120.2	2	2.3	7.8	82	181	
YE3-180L-4	22	30	1470	93	93	91.1	0.86	41.8	39.7	38.3	142.9	2	2.3	7.8	82	209	
YE3-200L-4	30	40	1475	93.6	93.6	91.7	0.86	56.6	53.8	51.8	194.2	2	2.3	7.3	84	284	
YE3-225S-4	37	50	1485	93.9	93.9	92	0.86	69.6	66.1	63.7	237.9	2	2.3	7.4	85	328	
YE3-225M-4	45	60	1485	94.2	94.2	92.3	0.86	84.4	80.2	77.3	289.4	2	2.3	7.4	86	363	
YE3-250M-4	55	75	1485	94.6	94.6	92.7	0.86	103	97.6	94.1	353.7	2.2	2.3	7.4	86	442	
YE3-280S-4	75	100	1486	95	95	93.1	0.88	136	139	125	482	2	2.3	6.9	89	569	
YE3-280M-4	90	125	1486	95.2	95.2	93.3	0.88	163	155	149	578.2	2	2.3	6.9	89	639	
YE3-315S-4	110	150	1488	95.4	95.4	93.5	0.89	197	187	180	706	2	2.2	7	89	939	
YE3-315M-4	132	180	1488	95.6	95.6	93.7	0.89	236	224	216	847.2	2	2.2	7	92	1033	
YE3-315L1-4	160	220	1488	95.8	95.8	93.9	0.89	285	271	261	1027	2	2.2	7.1	92	1126	
YE3-315L2-4	200	270	1490	96	96	94.1	0.9	352	334	322	1282	2	2.2	7.1	92	1238	
YE3-355M-4	250	340	1490	96	96	94.1	0.9	440	418	403	1602	2	2.2	7.1	101	1830	
YE3-355L-4	315	430	1490	96	96	94.1	0.9	554	526	507	2019	2	2.2	7.1	101	1950	



PD

**Diesel engine for pump
Motor diesel para bomba
Moteur diesel pour pompe**

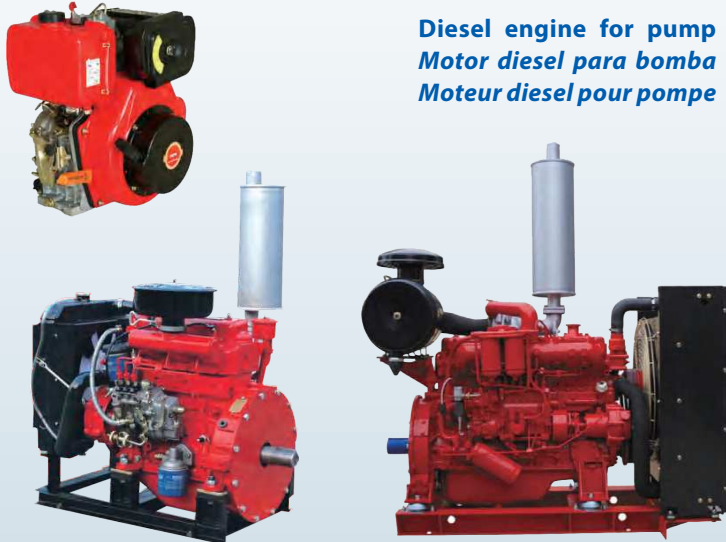

NEW/NUEVO/NOUVEAU

DESCRIPTION/DESCRIPCIONES/DESCRIPTION

- ◆ Air-cooled 1-cylinder in-line naturally aspirated engines
- ◆ Water-cooling 3-to 6-cylinder naturally and turbo engines
- ◆ Advanced direct injection and combustion system
- ◆ Extremely compact dimensions,easy to assemble
- ◆ Noise-optimized technology,stronger power
- ◆ Meeting China III emission standard
- ◆ Low fuel consumption,environmental protective
- ◆ Refrigerados por aire de 1 cilindro en línea motores
- ◆ Refrigeración por agua de 3 a 6 cilindros motores
- ◆ Sistema avanzado de inyección directa y combustión
- ◆ Dimensiones extremadamente compactas, fáciles de montar
- ◆ Tecnología de ruido optimizado, potencia más fuerte
- ◆ Cumple con el estándar de emisiones de China III
- ◆ Bajo consumo combustible, protección del medio ambiente
- ◆ Moteurs 1 cylindre à aspiration naturelle refroidis par air
- ◆ Refroidissement par eau de 3 à 6 cylindres moteurs
- ◆ Système avancé d'injection directe et de combustion
- ◆ Dimensions extrêmement compactes, faciles à assembler
- ◆ Technologie optimisée pour le bruit, puissance accrue
- ◆ Conforme à la norme d'émission China III
- ◆ Faible consommation de carburant

MODEL CODE/CÓDIGO MODELO/CODE MODÈLE

For example/Por ejemplo/Par exemple

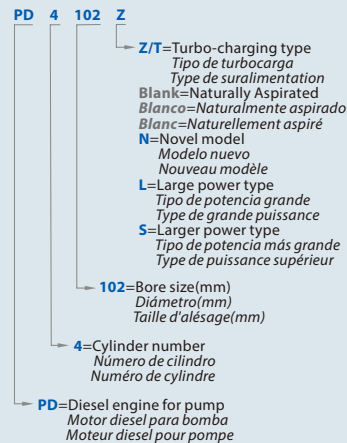

TECHNICAL DATA/DATOS TÉCNICOS/DONNÉES TECHNIQUES

Model Modelo Modèle	178	186	188	192	380	385	480	485	490N	490	495	498	4102	4105	4108
Type Tipo Type	4 strokes,Air cooling 4 tiempos,Refrigeración por aire 4 temps,refroidissement par air				Direct Injection,4 strokes, Water-cooling Inyección directa, 4 carreras, refrigeración por agua Injection directe, 4 temps, refroidissement par eau										
Intake Type Tipo de aspirada Type d'admission	Naturally Aspirated/Aspiración natural/Aspiration naturelle														
Bore*Stroke(mm) Diámetro *Carrera(mm) Alésage * Course(mm)	78*62	86*72	88*75	92*75	80*90	85*90	80*90	85*100	90*100	90*105	95*105	98*105	102*118	105*118	108*118
Cylinder No. Cilindro No. N° de cylindre	1	1	1	1	3	3	4	4	4	4	4	4	4	4	4
Displacement Desplazamiento Déplacement	0.296L	0.418L	0.456L	0.499L	1.357L	1.532L	1.8L	2.27L	2.54L	2.67L	2.977L	3.168L	3.857L	4.087L	4.324L
r/min	3000	3000	3000	3000	3000	3000	3000	3000	3000	3000	3000	3000	3000	3000	3000
Rated kW kW nominal kW nominale	3.7kW 4.0kW	5.7kW 6.3kW	6.6kW 7.2kW	7.5kW 8.2kW	20kW	24kW	28kW	36kW	42kW	45kW	50kW	54kW	62kW	67kW	73kW
Rated HP HP nominal HP nominale	5.0HP 5.5HP	7.8HP 8.6HP	9HP 10HP	10.2HP 12HP	27HP	32HP	38HP	49HP	58HP	61HP	68HP	73HP	85HP	91HP	99HP
Fuel Consumption(g/kw.h) El consumo combustible Consumo carburant	280.3 282.5	273.5 285.7	273.5 285.7	275 281	228	228	215	228	228	228	228	228	228	238	238
Start Voltage Voltaje de inicio Tension de démarrage	12V	12V	12V	12V	12V	12V	12V	12V	12V	12V	12V	12V	12V	24V	24V
Speed regulation type Tipo regulación Type régulation vitesse	Mechanical/Mecánico/Mécanique														
Including Incluso Comprenant	Radiator, Fan, Starter, charge alternator, Air filter, Muffler, Stop Solenoid, PTO shaft, Fuel Tank, Meter Panel Radiador, ventilador, arrancadora, alternador carga, filtro aire, silenciador, Solenoide parada, eje toma fuerza, tanque combustible, panel medidor Radiateur, ventilateur, démarreur, alternateur charge, filtre air, silencieux, solénoïde d'arrêt, arbre prise force, réservoir carburant, panneau compteur														

Model Modelo Modèle	485Z	490NZ	498Z	4102Z	4105Z	4108Z	490T	4108T	4108TL	6102NT	6102T	6102TL	6126T	6126TL	6126TS
Type Tipo Type	Direct Injection,4 strokes, Water-cooling Inyección directa, 4 carreras, refrigeración por agua Injection directe, 4 temps, refroidissement par eau														
Intake Type Tipo de aspirada Type d'admission	Turbo-charging/Turbocarga/Turbo-charge						Naturally			Turbo-charging/Turbocarga/Turbo-charge					
Bore*Stroke(mm) Diámetro *Carrera(mm) Alésage * Course(mm)	85*100	90*100	98*105	102*118	105*118	108*118	90*102	108*125	108*125	102*118	102*118	102*118	126*130	126*130	126*155
Cylinder No. Cilindro No. N° de cylindre	4	4	4	4	4	4	4	4	4	6	6	6	6	6	6
Displacement Desplazamiento Déplacement	2.27L	2.54L	3.168L	3.857L	4.087L	4.324L	2.6L	3.8L	3.8L	5.78L	5.78L	5.78L	9.726L	9.726L	9.726L
r/min	3000	3000	3000	3000	3000	3000	3000	3000	3000	3000	3000	3000	3000	3000	3000
Rated kW kW nominal kW nominale	44kW	50kW	60kW	73kW	75kW	83kW	55kW	75kW	90kW	110kW	125kW	165kW	200kW	250kW	300kW
Rated HP HP nominal HP nominale	60HP	68HP	81HP	99HP	102HP	113HP	75HP	100HP	125HP	150HP	170HP	225HP	270HP	340HP	410HP
Fuel Consumption(g/kw.h) El consumo combustible Consumo carburant	228	228	228	238	238	238	228	218	218	229	229	229	250	250	250
Start Voltage Voltaje de inicio Tension de démarrage	12V	12V	12V	24V	24V	24V	12V	24V	24V	24V	24V	24V	24V	24V	24V
Speed regulation type Tipo regulación Type régulation vitesse	Mechanical/Mecánico/Mécanique												Electronic Electrónico Électronique		
Including Incluso Comprenant	Radiator, Fan, Starter, charge alternator, Air filter, Muffler, Stop Solenoid, PTO shaft, Fuel Tank, Meter Panel Radiador, ventilador, arrancadora, alternador carga, filtro aire, silenciador, Solenoide parada, eje toma fuerza, tanque combustible, panel medidor Radiateur, ventilateur, démarreur, alternateur charge, filtre air, silencieux, solénoïde d'arrêt, arbre prise force, réservoir carburant, panneau compteur														

MATERIAL DESCRIPTION/DESCRIPCIÓN DE MATERIAL/DESCRIPTION DU MATÉRIEL

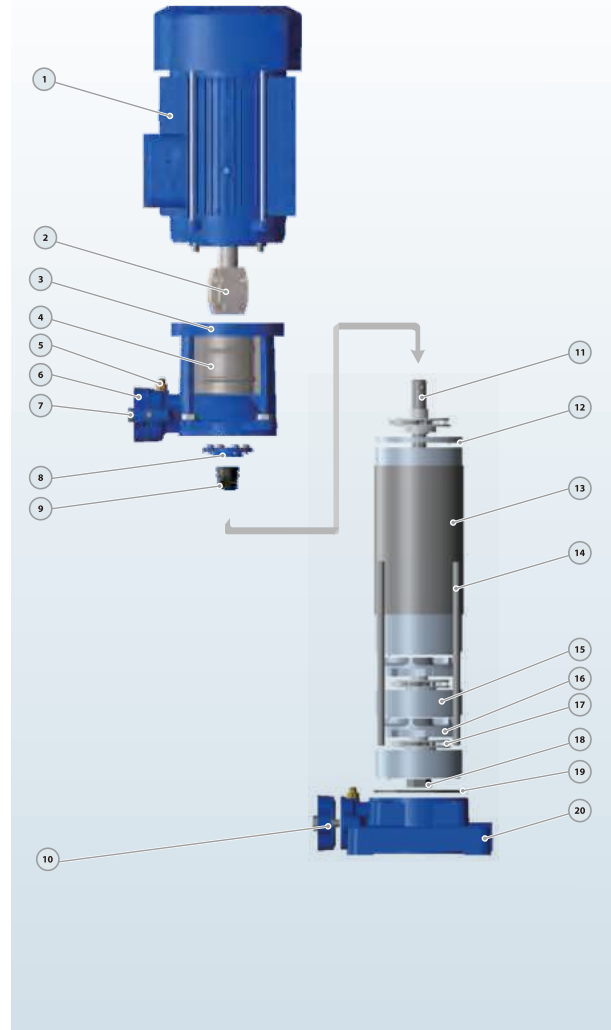

No.	Description Descripción Description	Material Material Matériel
1	Motor Motor Moteur	IP55 Class F IP55 Classe F IP55 classe F
2	Coupling Unión Couplage	Iron Hierro Le fer
3	Discharge Body Cuerpo Impulsión Corps de décharge	Cast iron Fundición Fonte
4	Cover Tapa Couverture	SS304 Inox 304 Inox 304
5	Release Valve Tapón Cebado Soupape de décharge	Brass Bronce Laiton
6	Discharge Impulsión Décharge	Cast iron Fundición Fonte
7	Bolt Perno Boulon	Steel Acero Acier
8	Seal Cover Tapa Cierre Couvercle de joint	Cast iron Fundición Fonte
9	Mechanical Seal Cierre Mecánico Garniture mécanique	SiC/Carbon/SS304 SiC/Grafito/Inox304 SiC/Carbon /Inox304
10	Suction Aspiración Suction	Cast iron Fundición Fonte
11	Pump Shaft Eje Arbre de pompe	SS304 Inox304 Inox304
12	Diffuser Top Cover Tapa Tapa Difusor Couvercle diffuseur	Technopolimer Technopolimero Technopolimer
13	Pump Cover Tapa Bomba Couvercle de pompe	SS304 Inox 304 Inox 304
14	Through Bolt Perno Traversant le boulon	Steel Acero Acier
15	Diffuser Cover Tapa Difusor Couvercle de diffuseur	Technopolimer with SS304 ring Technopolimero con Inox anillo Technopolimer avec anneau Inox
16	Diffuser Difusor Diffuseur	Technopolimer with SS304 ring Technopolimero con Inox anillo Technopolimer avec anneau Inox
17	Impeller Impulsor Roue	Technopolimer Technopolimero Technopolimer
18	Impeller Nut Tuerca de Impulsor Ecrou de roue	Galvanized Steel Acero Galvanizado Acier Galvanisé
19	O-ring Junta Tórica Joint torique	Rubber Caucho Caoutchouc
20	Suction Body Cuerpo Aspiración Corps d'aspiration	Cast iron Fundición Fonte

DIMENSIONS AND WEIGHT/DIMENSIONES Y PESOS/DIMENSIONS ET POIDS

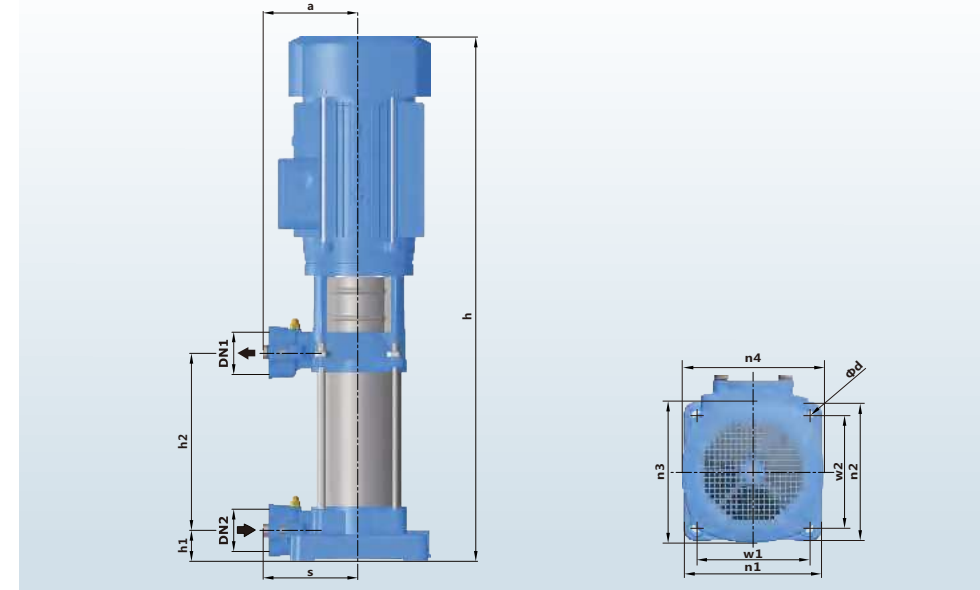

MODEL MODELO MODÈLE	DIMENSIONS/DIMENSIONES/DIMENSIONS mm														kg		
	DN1	DN2	N	a	s	h	h1	h2	w1	w2	n1	n2	n3	n4	d	1~	3~
PV 4x7/1.5	25/32	25/32	7	141	141	720	45.5	261.5	165	165	202	202	175	175	12	28.0	27.0
PV 4x9/2	25/32	25/32	9	141	141	790	45.5	331.5	165	165	202	202	175	175	12	33.0	32.0
PV 4x13/3	25/32	25/32	13	141	141	930	45.5	471.5	165	165	202	202	175	175	12	38.0	37.0
PV 4x16/4	25/32	25/32	16	141	141	1082	45.5	576.5	165	165	202	202	195	195	12	48.0	47.0
PV 6x5/1.5	25/32	25/32	5	141	141	650	45.5	191.5	165	165	202	202	175	175	12	26.0	25.0
PV 6x8/2	25/32	25/32	8	141	141	755	45.5	296.5	165	165	202	202	175	175	12	31.0	30.0
PV 6x11/3	25/32	25/32	11	141	141	860	45.5	401.5	165	165	202	202	175	175	12	36.0	35.0
PV 6x15/4	25/32	25/32	15	141	141	1047	45.5	541.5	165	165	202	202	195	195	12	46.0	45.0
PV 8x4/1.5	40/50	40/50	4	141	141	615	45.5	156.5	165	165	202	202	175	175	12	26.0	25.0
PV 8x7/2	40/50	40/50	7	141	141	720	45.5	261.5	165	165	202	202	175	175	12	31.0	30.0
PV 8x9/3	40/50	40/50	9	141	141	790	45.5	331.5	165	165	202	202	175	175	12	36.0	35.0
PV 8x12/4	40/50	40/50	12	141	141	942	45.5	436.5	165	165	202	202	195	195	12	46.0	45.0
PV 8x16/5.5	40/50	40/50	16	141	141	1082	45.5	576.5	165	165	202	202	195	195	12	-	50.0
PV 12x3/1.5	40/50	40/50	3	141	141	580	45.5	121.5	165	165	202	202	175	175	12	25.0	24.0
PV 12x5/2	40/50	40/50	5	141	141	650	45.5	191.5	165	165	202	202	175	175	12	30.0	29.0
PV 12x7/3	40/50	40/50	7	141	141	720	45.5	261.5	165	165	202	202	175	175	12	35.0	34.0
PV 12x9/4	40/50	40/50	9	141	141	837	45.5	331.5	165	165	202	202	195	195	12	45.0	44.0
PV 12x12/5.5	40/50	40/50	12	141	141	942	45.5	436.5	165	165	202	202	195	195	12	-	50.0
PV 12x17/7.5	40/50	40/50	17	141	141	1167	45.5	611.5	165	165	202	202	204	204	12	-	60.0
PV 30x7/10	50/65	50/65	7	170	170	1046	62	416	187	187	230	230	260	260	12	-	86.0
PV 30x9/12	50/65	50/65	9	170	170	1153	62	523	187	187	230	230	260	260	12	-	92.0
PV 30x11/15	50/65	50/65	11	170	170	1260	62	630	187	187	230	230	260	260	12	-	100



PVT

PVS



PVT/PVS

S.S.304 vertical multistage pump
Bomba de etapas múltiples inox304
Pompe multicellulaire verticale inox304

NEW/NUEVO/NOUVEAU

DESCRIPTION/DESCRIPCIONES/DESCRIPTION

- ◆ SS304 vertical, multistage centrifugal pump
 - ◆ The suction and discharge ports on the same level
 - ◆ PVT pump head and base are in cast iron
 - ◆ PVT pump impeller and shaft are in stainless steel
 - ◆ PVS pump all wetted parts are in stainless steel
 - ◆ YE3 high efficient motor, with protection IP55 class F
 - ◆ Quality bearing, wear resistance mechanical seal
 - ◆ Liquid temperature between -10°C and +120°C
- ◆ **Inox 304 bomba centrífuga vertical de etapas múltiples**
 - ◆ **Los puertos de succión y descarga en el mismo nivel**
 - ◆ **El cabezal y la base de la bomba PVT son de hierro fundido**
 - ◆ **El impulsor y el eje de la bomba PVT son de acero inoxidable**
 - ◆ **PVS todas las partes húmedas son de acero inoxidable**
 - ◆ **Motor de alta eficiencia YE3, con protección IP55 clase F**
 - ◆ **Rodamiento de marca NSK y cierre mecánico personalizado**
 - ◆ **Temperatura del líquido entre -10 °C y + 120 °C**
- ◆ **Pompe centrifuge multicellulaire verticale inox 304**
 - ◆ **Les orifices d'aspiration et de refoulement au même niveau**
 - ◆ **La tête et la base de la pompe PVT sont en fonte.**
 - ◆ **Roue et arbre de pompe PVT en acier inoxydable**
 - ◆ **PVS toutes les pièces en contact avec le fluide sont en inox**
 - ◆ **Moteur haute efficacité YE3, avec protection IP55 classe F**
 - ◆ **Roulement NSK qualité, joint mécanique résistance à l'usure**
 - ◆ **Température du liquide entre -10°C et + 120°C**

APPLICATIONS/APLICACIONES/APPLICATIONS

- ◆ The stainless steel multistage pumps are suitable for industrial processing systems, washing and cleaning systems, pumping of acids and alkalis, filtration systems, water pressure boosting, water treatment, HVAC, irrigation, fire protection systems etc.
- ◆ **Las bombas multietapa de acero inoxidable son adecuadas para sistemas de procesamiento industrial, sistemas de lavado y limpieza, bombeo de ácidos y álcalis, sistemas de filtración, aumento de la presión del agua, HVAC, riego, sistemas de protección contra incendios, etc.**
- ◆ **Les pompes à plusieurs étages en acier inoxydable conviennent systèmes de traitement industriel, systèmes de lavage et de nettoyage, pompage des acides et des alcalis, systèmes de filtration, à la surpression, traitement de l'eau, CVC, à l'irrigation, systèmes de protection contre les incendies, etc.**

MODEL CODE/CÓDIGO MODELO/CODE MODÈLE

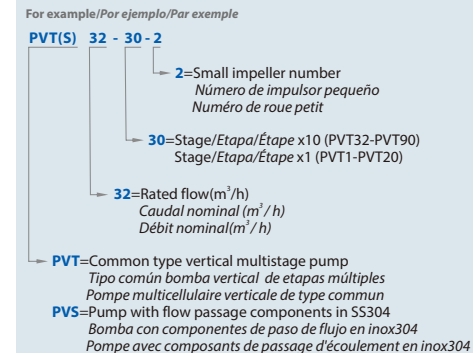

TECHNICAL DATA/DATOS TÉCNICOS/DONNÉES TECHNIQUES

50 Hz n=2900 1/min

MODEL MODELO MODÈLE	DN mm	Power Potencia Puissance		Q=DELIVERY/CAUDAL/DÉBIT															
		kw	hp	1.8	2.6	3.5	4.4	5.3	6.2	7	7.9	8.8	10.6	12.3	13.2	14.1	15.4	15.9	17.6
				gpm	l/min	7	10	13	17	20	23	27	30	33	40	47	50	53	58
				0.6	0.8	1	1.2	1.4	1.6	1.8	2	2.4	2.8	3	3.2	3.5	3.6	4	
				H=Head/Altura/Hauteur(m)															
				10	10.5	10	9.5	9	-	-	-	-	-	-	-	-	-	-	-
PVT 1-2	25x25	0.37	0.5	13	12.5	12	11.5	11	10.5	10	9.5	9	-	-	-	-	-	-	-
PVT 1-3	25x25	0.37	0.5	19	18	17.5	17	16.5	16	15	14	12	-	-	-	-	-	-	-
PVT 1-4	25x25	0.37	0.5	24	23.5	23	22.5	21.5	21	19	18	16	-	-	-	-	-	-	-
PVT 1-5	25x25	0.37	0.5	30	29.6	29	28	27	26	24	22	20	-	-	-	-	-	-	-
PVT 1-6	25x25	0.37	0.5	36	35.5	35	33.5	33	31	28	26	23	-	-	-	-	-	-	-
PVT 1-7	25x25	0.37	0.5	42	41	40.5	39	38	36	33	30	27	-	-	-	-	-	-	-
PVT 1-8	25x25	0.55	0.75	48	47	46	45	43	41	38	34	30	-	-	-	-	-	-	-
PVT 1-9	25x25	0.55	0.75	54	53	52	51	49	46	43	39	33	-	-	-	-	-	-	-
PVT 1-10	25x25	0.55	0.75	60	59	58	57	54	51	48	43	36	-	-	-	-	-	-	-
PVT 1-11	25x25	0.55	0.75	66	65	63	61	59	56	52	47	40	-	-	-	-	-	-	-
PVT 1-12	25x25	0.75	1	72	71	69	67	64	61	57	51	44	-	-	-	-	-	-	-
PVT 1-13	25x25	0.75	1	78	77	75	73	69	66	62	55	47	-	-	-	-	-	-	-
PVT 1-15	25x25	0.75	1	89	88	86	84	79	76	71	63	55	-	-	-	-	-	-	-
PVT 1-17	25x25	1.1	1.5	101	99	97	95	89	86	80	71	62	-	-	-	-	-	-	-
PVT 1-19	25x25	1.1	1.5	113	110	108	106	99	96	89	79	69	-	-	-	-	-	-	-
PVT 1-21	25x25	1.1	1.5	124	122	120	117	110	106	98	87	75	-	-	-	-	-	-	-
PVT 1-23	25x25	1.1	1.5	137	133	131	128	121	116	107	96	82	-	-	-	-	-	-	-
PVT 1-25	25x25	1.5	2	149	145	143	139	131	126	116	104	89	-	-	-	-	-	-	-
PVT 1-27	25x25	1.5	2	161	157	155	150	141	136	125	112	95	-	-	-	-	-	-	-
PVT 1-30	25x25	1.5	2	178	175	171	166	157	150	139	124	106	-	-	-	-	-	-	-
PVT 1-33	25x25	2.2	3	196	192	188	183	173	165	154	137	118	-	-	-	-	-	-	-
PVT 1-36	25x25	2.2	3	214	210	205	200	190	181	169	151	130	-	-	-	-	-	-	-
PVT 2-2	25x25	0.37	0.5	-	-	-	-	18	17	16	15	13	12	11	10	8	-	-	-
PVT 2-3	25x25	0.37	0.5	-	-	-	-	27	26	25	24	23	22	20	18	15	12	-	-
PVT 2-4	25x25	0.55	0.75	-	-	-	-	36	35	34	33	32	30	26	24	22	20	16	-
PVT 2-5	25x25	0.55	0.75	-	-	-	-	45	43	42	40	39	37	33	30	27	24	20	-
PVT 2-6	25x25	0.75	1	-	-	-	-	53	52	51	50	48	45	40	36	33	30	24	-
PVT 2-7	25x25	0.75	1	-	-	-	-	63	61	59	57	55	52	47	41	38	35	28	-
PVT 2-9	25x25	1.1	1.5	-	-	-	-	80	78	76	73	70	67	61	54	50	45	37	-
PVT 2-11	25x25	1.1	1.5	-	-	-	-	98	95	92	89	86	82	73	64	59	54	44	-
PVT 2-13	25x25	1.5	2	-	-	-	-	116	114	110	106	102	98	89	78	72	65	52	-
PVT 2-15	25x25	1.5	2	-	-	-	-	134	130	127	123	118	112	100	90	82	73	60	-
PVT 2-18	25x25	2.2	3	-	-	-	-	161	157	153	148	142	136	121	108	100	91	76	-
PVT 2-22	25x25	2.2	3	-	-	-	-	197	192	186	180	173	165	148	130	120	110	90	-
PVT 2-26	25x25	3	4	-	-	-	-	232	228	221	214	206	198	179	158	144	130	110	-
PVT 3-2	25x25	0.37	0.5	-	-	-	-	12.5	12	11.5	11	11	10.5	10	9	8	7	7	6
PVT 3-3	25x25	0.37	0.5	-	-	-	-	19	19	18.5	18	17.5	16.5	15	14	13	12	11	9
PVT 3-4	25x25	0.37	0.5	-	-	-	-	25	25	24	24	23	21.5	20	19	18	16	15	12
PVT 3-5	25x25	0.37	0.5	-	-	-	-	31	31	30	30	29	27	25	23	22	20	19	16
PVT 3-6	25x25	0.55	0.75	-	-	-	-	36	36	35	35	34	32	30	28	27	24	23	19
PVT 3-7	25x25	0.55	0.75	-	-	-	-	43	42	41	40	40	39	37	34	32	31	28	27
PVT 3-8	25x25	0.75	1	-	-	-	-	49	48	47	46	45	43	39	37	35	32	31	25
PVT 3-9	25x25	0.75	1	-	-	-	-	55	54	53	52	51	48	45	42	40	36	35	28
PVT 3-10	25x25	0.75	1	-	-	-	-	61	60	59	58	57	54	50	47	45	41	39	31
PVT 3-11	25x25	1.1	1.5	-	-	-	-	67	66	64	63	61	58	54	51	49	44	42	34
PVT 3-12	25x25	1.1	1.5	-	-	-	-	73	72	70	69	67	63	58	55	52	47	45	37
PVT 3-13	25x25	1.1	1.5	-	-	-	-	78	77	76	75	73	69	64	60	57	51	49	40
PVT 3-15	25x25	1.1	1.5	-	-	-	-	90	89	88	86	84	79	73	69	66	59	57	46
PVT 3-17	25x25	1.5	2	-	-	-	-	103	102	100	98	96	90	83	79	75	67	64	52
PVT 3-19	25x25	1.5	2	-	-	-	-	115	114	112	110	107	100	92	88	83	75	72	58
PVT 3-21	25x25	2.2	3	-	-	-	-	128	126	124	122	119	112	102	98	91	82	79	64
PVT 3-23	25x25	2.2	3	-	-	-	-	140	138	135	133	130	122	112	107	100	90	86	70
PVT 3-25	25x25	2.2	3	-	-	-	-	151	149	147	144	141	131	122	116	109	98	94	76
PVT 3-27	25x25	2.2	3	-	-	-	-	164	162	159	156	152	143	132	124	117	105	101	82
PVT 3-29	25x25	2.2	3	-	-	-	-	175	173	170	167	163	153	142	133	126	113	109	88
PVT 3-31	25x25	3	4	-	-	-	-	187	185	182	179	175	165	153	142	135	121	116	94
PVT 3-33	25x25	3	4	-	-	-	-	199	197	194	191	187	176	163	151	145	130	125	100
PVT 3-36	25x25	3	4	-	-	-	-	218	215	212	208	204	192	178	168	159	143	137	109

PVS also available/también disponible/aussi disponible

Performance curve in page/Curva en página/Courbe en page 179-181

DIMENSIONS AND WEIGHT/DIMENSIONES Y PESOS/DIMENSIONS ET POIDS

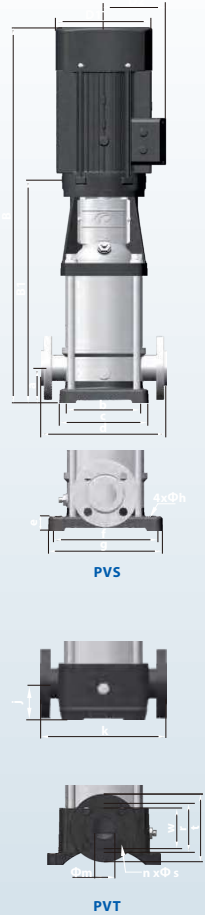

	B1	B	D1	D2	COMMON COMUN COMMUN	kg		B1	B	D1	D2	COMMON COMUN COMMUN	kg
1-2	258	483	148	117	DN=25 a=50 b=100 c=150 d=210 e=20 f=180 g=210 h=13 j=75 k=250 m=32 n=4 r=85 s=14 t=115 w=60	20	4-2	276	501	148	117	DN=32 a=50 b=100 c=150 d=210 e=20 f=180 g=210 h=13 j=75 k=250 m=32 n=4 r=100 s=18 t=140 w=60	21
1-3	276	501	148	117		20	4-3	303	528	148	117	22	
1-4	294	519	148	117		21	4-4	340	585	170	142	25	
1-5	312	537	148	117		21	4-5	367	612	170	142	27	
1-6	330	555	148	117		22	4-6	394	639	170	142	27	
1-7	348	573	148	117		23	4-7	431	721	190	155	33	
1-8	366	591	148	117		24	4-8	458	748	190	155	33	
1-9	384	609	148	117		25	4-10	512	802	190	155	37	
1-10	402	627	148	117		26	4-12	566	856	190	155	38	
1-11	420	645	148	117		26	4-14	630	975	197	165	46	
1-12	448	693	170	142		29	4-16	684	1029	197	165	48	
1-13	466	711	170	142		30	4-19	765	1120	230	188	57	
1-15	502	747	170	142		31	4-22	846	1201	230	188	59	
1-17	538	783	170	142		33	8-2-1	347	592	170	142	32	
1-19	574	819	170	142		34	8-2	347	592	170	142	32	
1-21	610	855	170	142		35	8-3	377	622	170	142	34	
1-23	646	891	170	142		36	8-4	417	707	190	155	40	
1-25	692	982	190	155		42	8-5	447	737	190	155	44	
1-27	728	1018	190	155		43	8-6	477	767	190	155	45	
1-30	782	1072	190	155		45	8-8	547	892	197	165	53	
1-33	836	1126	190	155		49	8-8	547	892	197	165	53	
1-36	890	1180	190	155		51	8-10	607	962	230	188	64	
2-2	258	483	148	117		20	8-12	667	1022	230	188	66	
2-3	276	501	148	117		20	8-14	747	1137	260	208	81	
2-4	294	519	148	117		22	8-16	807	1197	260	208	84	
2-5	312	537	148	117		23	8-18	867	1257	260	208	93	
2-6	340	585	170	142		26	8-20	927	1317	260	208	94	
2-7	358	603	170	142		26	10-1	347	592	170	142	40	
2-9	394	639	170	142		28	10-2	347	592	170	142	41	
2-11	430	675	170	142		29	10-3	377	622	170	142	43	
2-13	476	766	190	155		35	10-4	417	707	190	155	49	
2-15	512	802	190	155		36	10-5	447	737	190	155	53	
2-18	566	856	190	155		41	10-6	477	767	190	155	54	
2-22	638	928	190	155	42	10-7	517	862	197	165	64		
2-26	720	1065	197	165	52	10-8	547	892	197	165	65		
3-2	258	483	148	117	20	10-9	577	922	197	165	66		
3-3	276	501	148	117	20	10-10	607	962	230	188	74		
3-4	294	519	148	117	21	10-12	667	1022	230	188	76		
3-5	312	537	148	117	21	10-14	747	1137	260	208	100		
3-6	330	555	148	117	23	10-16	807	1197	260	208	102		
3-7	348	573	148	117	24	10-18	867	1257	260	208	107		
3-8	376	621	170	142	27	10-20	927	1317	260	208	109		
3-9	394	639	170	142	28	10-22	987	1377	260	208	111		
3-10	412	657	170	142	28	12-2	367	657	190	155	39		
3-11	430	675	170	142	29	12-3	397	687	190	155	43		
3-12	448	693	170	142	30	12-4	437	782	197	165	51		
3-13	466	711	170	142	31	12-5	467	812	197	165	53		
3-15	502	747	170	142	32	12-6	497	852	230	188	61		
3-17	548	838	190	155	38	12-7	547	937	260	208	73		
3-19	584	874	190	155	39	12-8	577	967	260	208	74		
3-21	620	910	190	155	42	12-9	607	997	260	208	76		
3-23	656	946	190	155	43	12-10	637	1027	260	208	83		
3-25	692	982	190	155	44	12-12	697	1087	260	208	87		
3-27	728	1018	190	155	45	12-14	845	1345	330	255	157		
3-29	764	1054	190	155	46	12-16	905	1405	330	255	161		
3-31	810	1155	197	165	54	12-18	965	1465	330	255	164		
3-33	846	1191	197	165	55								
3-36	900	1245	197	165	57								

DIMENSIONS AND WEIGHT/DIMENSIONES Y PESOS/DIMENSIONS ET POIDS

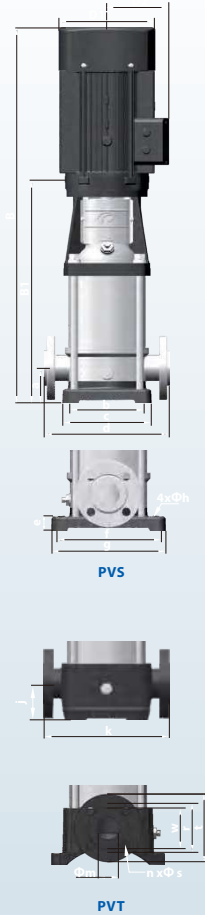

	B1	B	D1	D2	COMMON COMUN COMMUN	kg		B1	B	D1	D2	COMMON COMUN COMMUN	kg
16-2	397	687	190	155	DN=80 a=140 b=190 c=245 d=365 e=45 f=266 g=330 h=14 j=140 k=365 m=80 n=8 r=160 s=18 t=200 w=120	42	45-10-1	561	906	197	165	83	
16-3	452	797	197	165		50	45-10	561	916	230	188	90	
16-4	497	852	230	188		59	45-20-2	641	1031	260	208	105	
16-5	562	952	260	208		76	45-20	641	1031	260	208	110	
16-6	607	997	260	208		77	45-30-2	826	1326	330	255	183	
16-7	652	1042	260	208		84	45-30	826	1326	330	255	183	
16-8	697	1087	260	208		86	45-40-2	906	1406	330	255	197	
16-10	875	1375	330	255		158	45-40	906	1406	330	255	197	
16-12	965	1465	330	255		161	45-50-2	986	1536	330	255	221	
16-14	1055	1555	330	255		174	45-50	986	1536	330	255	221	
16-16	1145	1645	330	255		178	45-60-2	1066	1641	360	285	261	
20-1	387	632	170	142		33	45-60	1066	1641	360	285	261	
20-2	397	687	190	155		42	45-70-2	1146	1796	400	310	320	
20-3	452	807	230	188		58	45-70	1146	1796	400	310	320	
20-4	517	907	260	208		74	45-80-2	1226	1876	400	310	324	
20-5	562	952	260	208		76	45-80	1226	1876	400	310	324	
20-6	607	997	260	208		82	45-90-2	1306	1956	400	310	328	
20-7	652	1042	260	208		84	45-90	1306	1956	400	310	328	
20-8	785	1285	330	255		153	45-100-2	1386	2036	400	310	355	
20-10	875	1375	330	255		157	45-100	1386	2036	400	310	355	
20-12	965	1465	330	255		170	45-110-2	1466	2151	450	345	426	
20-14	1055	1555	330	255		172	45-110	1466	2151	450	345	426	
20-17	1190	1740	330	255		195	45-120-2	1546	2231	450	345	432	
32-10-1	505	795	190	155		64	45-120	1546	2231	450	345	432	
32-10	505	795	190	155		68	45-130-2	1626	2311	450	345	438	
32-20-2	575	920	197	165		77	64-10-1	561	916	230	188	93	
32-20	575	930	230	188		85	64-10	561	951	260	208	105	
32-30-2	645	1035	260	208		100	64-20-2	644	1034	260	208	110	
32-30	645	1035	260	208		100	64-20	754	1254	330	255	182	
32-40-2	715	1105	260	208		109	64-30-1	836	1336	330	255	196	
32-40	715	1105	260	208		109	64-30-2	836	1336	330	255	197	
32-50-2	890	1390	330	255		181	64-30	836	1386	330	255	221	
32-50	890	1390	330	255		181	65-40-2	919	1469	330	255	225	
32-60-2	960	1460	330	255	185	64-40-1	919	1494	360	285	258		
32-60	960	1460	330	255	185	64-40	919	1494	360	285	258		
32-70-2	1030	1530	330	255	199	64-50-2	1001	1651	400	310	319		
32-70	1030	1530	330	255	199	64-50-1	1001	1651	400	310	320		
32-80-2	1100	1600	330	255	203	64-60-2	1084	1734	400	310	325		
32-80	1100	1600	330	255	203	64-60-1	1084	1734	400	310	325		
32-90-2	1170	1720	330	255	222	64-70	1084	1734	400	310	349		
32-90	1170	1720	330	255	222	64-70-2	1166	1816	400	310	353		
32-100-2	1240	1790	330	255	227	64-70-1	1166	1816	400	310	353		
32-100	1240	1790	330	255	227	64-70	1166	1851	460	340	420		
32-110-2	1310	1885	360	285	272	64-80-2	1248	1933	460	340	424		
32-110	1310	1885	360	285	272	64-80-1	1248	1933	460	340	424		
32-120-2	1380	1955	360	285	276	90-10-1	571	961	260	208	105		
32-120	1380	1955	360	285	276	90-10	571	961	260	208	110		
32-130-2	1450	2100	400	310	337	90-20-2	571	961	260	208	110		
32-130	1450	2100	400	310	337	90-20-1	773	1273	330	255	181		
32-140-2	1520	2170	400	310	341	90-20	773	1273	330	255	192		
32-140	1520	2170	400	310	341	90-30-2	865	1415	330	255	215		
32-150-2	1590	2240	400	310	345	90-30	865	1440	360	285	252		
32-15													

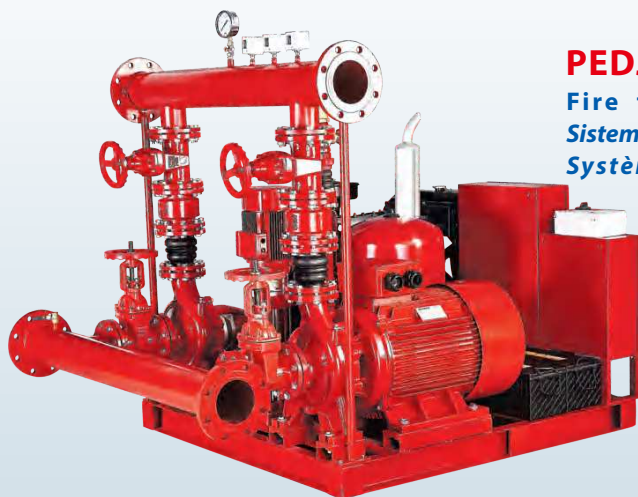

PEDJ

Fire fighting system

Sistema de contra incendio

Système anti-incendie

NEW/NUEVO/NOUVEAU

DESCRIPTION/DESCRIPCIONES/DESCRIPTION

- ♦ Fire pumps are designed for whole operational life, the maximum reliability is always the first priority
 - ♦ The components affixed onto a steel framing structure
 - ♦ Each controller has its own individual pressure sensing line
 - ♦ The suction line should never include a strainer
 - ♦ Check valve and butterfly valve in the discharge line
 - ♦ NFPA 20 no allows suction from negative level for end suction and split case pumps
- ♦ Bombas contra incendios están diseñadas para vida operativa completa, la máxima fiabilidad es siempre primera prioridad
 - ♦ Los componentes se fijarán en una estructura armazón de acero
 - ♦ Cada controlador tendrá su propia línea detección presión
 - ♦ La línea de succión nunca debe incluir un filtro
 - ♦ Válvula de retención y mariposa en la línea de descarga
 - ♦ NFPA 20 no permite la succión desde el nivel negativo para la succión final y las bombas de carcasa dividida
- ♦ Pompes à incendie sont conçues pour toute la durée de vie opérationnelle, la fiabilité maximale est toujours la première priorité
 - ♦ Tous les composants fixés sur une structure charpente en acier
 - ♦ Chaque contrôleur possède sa propre ligne détection pression
 - ♦ La conduite d'aspiration ne doit jamais comprendre de crépine
 - ♦ Clapet anti-retour et papillon dans la conduite de refoulement
 - ♦ NFPA 20 n'autorise pas l'aspiration à partir du niveau négatif pour les pompes à aspiration d'extrémité et à boîtier divisé

PRINCIPLE/PRINCIPIO/PRINCIPE

- When pressure drops below the set value, jockey starts running with the signal from the pressure switch and continues running for 10 minutes till the system pressure reaches the set value. If the pressure continues drop, first the main pump starts to run. If the system pressure can't supply and pressure continues drop, the standby pump starts to run.
- Cuando la presión cae por debajo del valor, jockey comienza a funcionar con la señal del interruptor de presión y continúa funcionando durante 10 minutos hasta que la presión del sistema alcanza el valor establecido. Si la presión continúa bajando, primero la bomba principal comienza a funcionar. Si la presión del sistema no puede suministrar y la presión continúa bajando, la bomba de reserva comienza a funcionar.
- Lorsque la pression chute en dessous de la valeur, jockey commence à fonctionner avec le signal du pressostat et continue de fonctionner pendant 10 minutes jusqu'à ce que la pression du système atteigne la valeur définie. Si la pression continue de chuter, la pompe principale commence d'abord à fonctionner. Si la pression du système ne peut pas fournir et que la pression continue de chuter, la pompe de secours commence à fonctionner.

For example/ Por ejemplo/ Par exemple

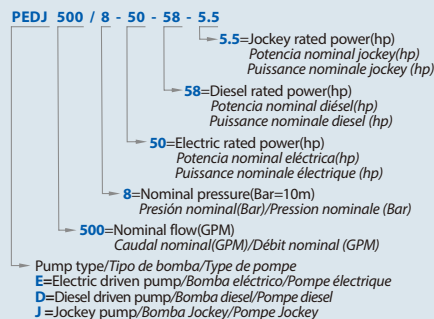

NFPA 20 FIRE PUMP VERSIONS/VERSIONES DE LA BOMBA CONTRA INCENDIOS NFPA 20/VERSIONS DE POMPE À INCENDIE NFPA 20

DESCRIPTION/DESCRIPCION/DESCRIPTION	PHOTO/FOTO/PHOTO
<p>PEJ Version: Fire pump set consists of Electric pump+Diesel pump+Jockey pump and all accessories</p> <p>Versión PEJ: Consiste en una bomba eléctrica + bomba diesel + bomba Jockey y todos los accesorios</p> <p>Versión PEJ: L'ensemble de pompe à incendie comprend pompe électrique +pompe diesel +pompe Jockey et tous les accessoires</p>	
<p>PDJ Version: Fire pump set consists of Diesel pump+Jockey pump and all accessories</p> <p>Versión PDJ: Consiste en una bomba Diesel + bomba Jockey y todos los accesorios.</p> <p>Versión PDJ: L'ensemble de pompe à incendie comprend pompe diesel + pompe Jockey et tous les accessoires.</p>	
<p>PEJ Version: Fire pump set consists of Electric pump+Jockey pump and all accessories</p> <p>Versión PEJ: Consiste en una bomba eléctrica + bomba Jockey y todos los accesorios</p> <p>Versión PEJ: L'ensemble de pompe à incendie comprend pompe électrique +pompe Jockey et tous les accessoires</p>	
<p>PEEJ Version: Fire pump set consists of Electric pump+Electric pump+Jockey pump and all accessories</p> <p>Versión PEEJ: Consiste en una bomba eléctrica + bomba eléctrica + bomba Jockey y todos los accesorios</p> <p>Versión PEEJ: L'ensemble de pompe à incendie comprend pompe électrique +pompe électrique + pompe Jockey et tous les accessoires</p>	

TECHNICAL DATA/DATOS TÉCNICOS/DONNÉES TECHNIQUES

50 Hz n=2900 1/min

Image	Q	H	Electric/Electrico/Électrique		Diesel/Diésel/Diesel	Jockey/Jockey/Jockey	
			Option 1	Option 2	Coupling type Tipo acoplado Type d'accouplement	Option 1	Option 2
			Close coupled Coplado cerrado Couplage étroit	Separate coupled Acoplado separado Séparé couplé		Plastic impeller Impulsor plástico Roue plastique	SS304 impeller Impulsor Inox304 Roue inox304
GPM	Bar	Image	Image	Image	Image	Image	
PEDJ 50/6-5.5-8.6-2	50	6	P2C 32-200/40 5.5HP	PSM 32-250/55 7.5HP	PSD 32-250/55 8.6HP	PV 4x9/2HP	PVT(S) 1-15 1HP
PEDJ 50/7-7.5-10-2	50	7	P2C 40-210/55 7.5HP	PSM 32-250/75 10HP	PSD 32-250/75 10HP	PV 4x9/2HP	PVT(S) 1-15 1HP
PEDJ 50/8-10-12-3	50	8	P2C 40-210/75 10HP	PSM 32-250/110 15HP	PSD 32-250/110 12HP	PV 4x13/3HP	PVT(S) 1-15 1HP
PEDJ 50/9-10-27-3	50	9	P2C 40-210/75 10HP	PSM 32-250/150 20HP	PSD 32-250/150 27HP	PV 4x13/3HP	PVT(S) 1-17 1.5HP
PEDJ 100/7-10-10-2	100	6-7	PST 32-250/75 10HP	PSM 32-250/75 10HP	PSD 32-250/75 10HP	PV 4x9/2HP	PVT(S) 2-11 1.5HP
PEDJ 100/8-15-27-3	100	8	P2C 40-200/110 15HP	PSM 32-250/150 20HP	PSD 32-250/150 27HP	PV 4x13/3HP	PVT(S) 2-13 2HP
PEDJ 100/9-17.5-27-3	100	9	P2C 40-250/130 17.5HP	PSM 40-250/185 25HP	PSD 40-250/185 27HP	PV 4x13/3HP	PVT(S) 2-13 2HP
PEDJ 120/7-10-12-3	120	7	PST 32-250/75D 10HP	PSM 32-250/75H 10HP	PSD 32-250/75H 12HP	PV 4x13/3HP	PVT(S) 2-13 2HP
PEDJ 150/7-15-12-3	150	7	PST 40-250/110 15HP	PSM 40-250/110 15HP	PSD 40-250/110 12HP	PV 4x13/3HP	PVT(S) 4-10 3HP
PEDJ 200/6-20-27-3	200	6	PST 50-250/150 20HP	PSM 50-250/150 20HP	PSD 50-250/150 27HP	PV 4x13/3HP	PVT(S) 4-10 3HP
PEDJ 200/7-25-27-3	200	7	PST 50-250/185 25HP	PSM 50-250/185 25HP	PSD 50-250/185 27HP	PV 4x13/3HP	PVT(S) 4-10 3HP
PEDJ 200/8-30-32-3	200	8	PST 50-250/220 30HP	PSM 50-250/220 30HP	PSD 50-250/220 32HP	PV 4x13/3HP	PVT(S) 4-12 3HP
PEDJ 200/9-40-38-4	200	9	-	PSM 50-250/300 40HP	PSD 50-250/300 38HP	PV 4x16/4HP	PVT(S) 4-12 3HP
PEDJ 200/10-50-58-4	200	10	-	PSM 50-315/370 50HP	PSD 50-315/370 58HP	PV 6x15/4HP	PVT(S) 4-14 4HP
PEDJ 250/7-25-27-4	250	7	PST 50-250/185 25HP	PSM 50-250/185 25HP	PSD 50-250/185 27HP	PV 6x15/4HP	PVT(S) 4-12 3HP
PEDJ 300/6-25-27-4	300	6	PST 50-250/185 25HP	PSM 50-250/185 25HP	PSD 50-250/185 27HP	PV 6x15/4HP	PVT(S) 8-6 3HP
PEDJ 300/7-30-32-4	300	7	PST 50-250/220 30HP	PSM 50-250/220 30HP	PSD 50-250/220 32HP	PV 6x15/4HP	PVT(S) 8-8 4HP
PEDJ 300/8-40-38-4	300	8	-	PSM 50-250/300 40HP	PSD 50-250/300 38HP	PV 8x12/4HP	PVT(S) 8-8 4HP
PEDJ 300/10-50-58-5.5	300	9-10	-	PSM 50-315/370 50HP	PSD 50-315/370 58HP	PV 8x16/5.5HP	PVT(S) 8-12 5.5HP
PEDJ 350/7-30-32-4	350	7	PST 50-250/220 30HP	PSM 50-250/220 30HP	PSD 50-250/220 32HP	PV 8x12/4HP	PVT(S) 8-8 4HP
PEDJ 400/6-30-32-4	400	6	PST 65-250/220 30HP	PSM 65-250/220 30HP	PSD 65-250/220 32HP	PV 8x12/4HP	PVT(S) 8-8 4HP
PEDJ 400/7-40-38-5.5	400	7	PST 65-250/300 40HP	PSM 65-250/300 40HP	PSD 65-250/300 38HP	PV 8x16/5.5HP	PVT(S) 8-8 4HP
PEDJ 400/8-50-58-5.5	400	8	PST 65-250/370 50HP	PSM 65-250/370 50HP	PSD 65-250/370 58HP	PV 8x16/5.5HP	PVT(S) 8-10 5.5HP
PEDJ 400/9-60-61-7.5	400	9	PST 65-315/450 60HP	PSM 65-315/450 60HP	PSD 65-315/450 61HP	PV 12x17/7.5HP	PVT(S) 8-12 5.5HP
PEDJ 500/7-40-38-5.5	500	6-7	PST 65-250/300 40HP	PSM 65-250/300 40HP	PSD 65-250/300 38HP	PV 12x12/5.5HP	PVT(S) 12-8 7.5HP
PEDJ 500/8-50-58-7.5	500	8	PST 65-250/370 50HP	PSM 65-250/370 50HP	PSD 65-250/370 58HP	PV 12x17/7.5HP	PVT(S) 12-8 7.5HP
PEDJ 500/9-60-61-7.5	500	9	PST 65-315/450 60HP	PSM 65-315/450 60HP	PSD 65-315/450 61HP	PV 12x17/7.5HP	PVT(S) 12-9 7.5HP
PEDJ 500/11-75-75-7.5	500	10-11	PST 65-315/550 75HP	PSM 65-315/550 75HP	PSD 65-315/550 75HP	PV 12x17/7.5HP	PVT(S) 12-12 10HP
PEDJ 500/13-100-100-15	500	12-13	PST 65-315/750 100HP	PSM 65-315/750 100HP	PSD 65-315/750 100HP	PV 30x11/15HP	PVT(S) 12-14 15HP

PDJ PEJ PEEJ also available/también disponible/aussi disponible

Other model can provide on request/Otro modelo disponible/Autre modèle disponible

TECHNICAL DATA/DATOS TÉCNICOS/DONNÉES TECHNIQUES

50 Hz n=2900 1/min

Image	Q	H	Electric/Electrico/Électrique		Diesel/Diésel/Diesel	Jockey/Jockey/Jockey	
			Option 1	Option 2	Coupling type Tipo acoplado Type d'accouplement	Option 1	Option 2
			Close coupled Coplado cerrado Couplage étroit	Separate coupled Acoplado separado Séparé couplé		Plastic impeller Impulsor plástico Roue plastique	SS304 impeller Impulsor Inox304 Roue inox304
GPM	Bar	Image	Image	Image	Image	Image	
PEDJ 500/14-125-125-15	500	14	PST 65-315/900 125HP	PSM 65-315/900 125HP	PSD 65-315/900 125HP	PV 30x11/15HP	PVT(S) 12-14 15HP
PEDJ 750/7-60-61-10	750	6-7	PST 80-250/450 60HP	PSM 80-250/450 60HP	PSD 80-250/450 61HP	PV 30x7/10HP	PVT(S) 16-8 10HP
PEDJ 750/8-75-75-10	750	8	PST 80-250/550 75HP	PSM 80-250/550 75HP	PSD 80-250/550 75HP	PV 30x7/10HP	PVT(S) 16-8 10HP
PEDJ 750/9-100-100-10	750	9	-	PSM 80-250/750 100HP	PSD 80-250/750 100HP	PV 30x7/10HP	PVT(S) 16-8 10HP
PEDJ 750/11-100-100-12	750	10-11	PST 80-315/750 100HP	PSM 80-315/750 100HP	PSD 80-315/750 100HP	PV 30x9/12HP	PVT(S) 16-10 15HP
PEDJ 750/13-125-125-15	750	12-13	PST 80-315/900 125HP	PSM 80-315/900 125HP	PSD 80-315/900 125HP	PV 30x11/15HP	PVT(S) 16-12 15HP
PEDJ 750/14-150-150-15	750	14	-	PSM 80-315/1100 150HP	PSD 80-315/1100 150HP	PV 30x11/15HP	PVT(S) 16-14 20HP
PEDJ 1000/8-100-100-10	1000	8	PST 100-250/750 100HP	PSM 100-250/750 100HP	PSD 100-250/750 100HP	PV 30x7/10HP	PVT(S) 20-8 15HP
PEDJ 1000/9-125-125-12	1000	9	PST 100-250/900 125HP	PSM 100-250/900 125HP	PSD 100-250/900 125HP	PV 30x9/12HP	PVT(S) 20-10 15HP
PEDJ 1000/11-150-150-12	1000	10-11	PST 100-315/1100 150HP	PSM 100-315/1100 150HP	PSD 100-315/1100 150HP	PV 30x9/12HP	PVT(S) 20-10 15HP
PEDJ 1000/12-180-170-15	1000	12	PST 100-315/1320 180HP	PSM 100-315/1320 180HP	PSD 100-315/1320 170HP	PV 30x11/15HP	PVT(S) 20-14 20HP
PEDJ 1000/14-220-225-20	1000	13-14	PST 100-315/1600 220HP	PSM 100-315/1600 220HP	PSD 100-315/1600 225HP	-	PVT(S) 20-14 20HP
PEDJ 1250/8-150-150-12	1250	8	-	PSM 125-250/1100 150HP	PSD 125-250/1100 150HP	PV 30x9/12HP	PVT(S) 32-60 15HP
PEDJ 1250/9-180-170-15	1250	9	-	PSM 125-315/1320 180HP	PSD 125-315/1320 170HP	PV 30x11/15HP	PVT(S) 32-60 15HP
PEDJ 1250/11-220-225-15	1250	10-11	-	PSM 125-315/1600 220HP	PSD 125-315/1600 225HP	PV 30x11/15HP	PVT(S) 32-80 20HP
PEDJ 1250/12-250-270-20	1250	12	-	PSM 125-315/1850 250HP	PSD 125-315/1850 270HP	-	PVT(S) 32-80 20HP
PEDJ 1250/13-270-270-25	1250	13	-	PSM 125-315/2000 270HP	PSD 125-315/2000 270HP	-	PVT(S) 32-100 25HP
PEDJ 1500/8-180-170-15	1500	8	-	PSM 125-250H/1320 180HP	PSD 125-250H/1320 170HP	PV 30x11/15HP	PVT(S) 32-80 20HP
PEDJ 1500/9-180-170-20	1500	9	-	PSM 125-315/1320 180HP	PSD 125-315/1320 170HP	-	PVT(S) 32-80 20HP
PEDJ 1500/10-220-225-20	1500	10	-	PSM 125-315/1600 220HP	PSD 125-315/1600 225HP	-	PVT(S) 32-80 20HP
PEDJ 1500/12-250-270-25	1500	11-12	-	PSM 125-315/1850 250HP	PSD 125-315/1850 270HP	-	PVT(S) 32-100 25HP
PEDJ 1500/13-270-270-25	1500	13	-	PSM 125-315/2000 270HP	PSD 125-315/2000 270HP	-	PVT(S) 32-100 25HP
PEDJ 2000/8-220-225-25	2000	8	-	PSM 150-250/1600 220HP	PSD 150-250/1600 225HP	-	PVT(S) 45-50 25HP
PEDJ 2000/9-270-270-25	2000	9	-	PSM 150-250/2000 270HP	PSD 150-250/2000 270HP	-	PVT(S) 45-50 25HP
PEDJ 2000/10-340-340-30	2000	10	-	PSM 150-315/2500 340HP	PSD 150-315/2500 340HP	-	PVT(S) 45-60 30HP
PEDJ 2000/13-430-410-40	2000	11-13	-	PSM 150-315/3150 430HP	PSD 150-315/3150 410HP	-	PVT(S) 45-70 40HP
PEDJ 2500/8-220-225-30	2500	8	-	PSM 150-250/1600 220HP	PSD 150-250/1600 225HP	-	PVT(S) 64-40 30HP
PEDJ 2500/9-270-270-40	2500	9	-	PSM 150-250/2000 270HP	PSD 150-250/2000 270HP	-	PVT(S) 64-50 40HP
PEDJ 2500/10-340-340-40	2500	10	-	PSM 150-315/2500 340HP	PSD 150-315/2500 340HP	-	PVT(S) 64-50 40HP
PEDJ 2500/12-430-410-40	2500	11-12	-	PSM 150-315/3150 430HP	PSD 150-315/3150 410HP	-	PVC(S) 64-60-2 40HP

PDJ PEJ PEEJ also available/también disponible/aussi disponible

Other model can provide on request/Otro modelo disponible/Autre modèle disponible

MATERIAL DESCRIPTION/DESCRIPCIÓN DE MATERIAL/DESCRIPTION DU MATÉRIEL

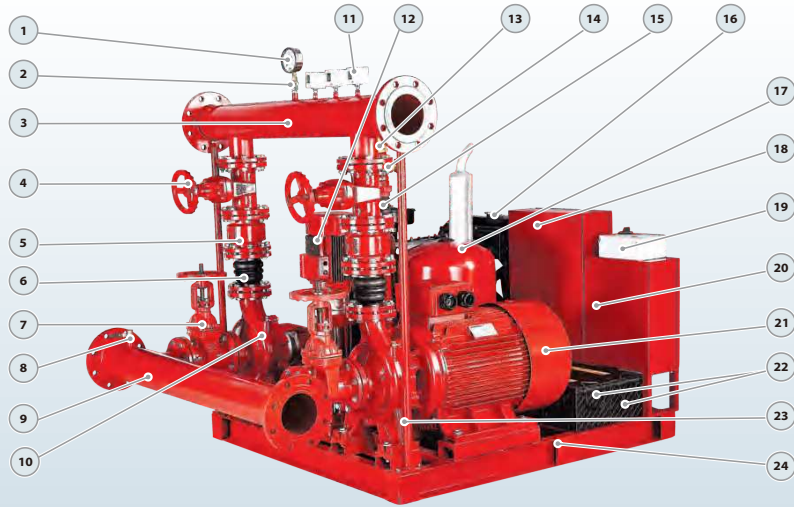

No.	Description Descripción Description	Material Material Matériel	No.	Description Descripción Description	Material Material Matériel	No.	Description Descripción Description	Material Material Matériel
1	Pressure Gauge Manómetro Manomètre	0-16bar 0-16bar 0-16bar	9	Suction pipeline Tubería de succión Canalisation d'aspiration	Carbon steel Acero carbono Acier Carbone	17	Pressure tank Tanque de presión Réservoir de pression	Iron/EPDM membrane Hierro/Membrana EPDM Fer-Membrane EPDM
2	Relief Valve Válvula de alivio Soupape de décharge	Brass Latón Laiton	10	Diesel pump Bomba diesel Pompe diesel	Standby supplier Proveedor en espera Fournisseur de secours	18	Electric controller Controladora eléctrica Contrôleur lectrique	DOL/Star-delta DOL/Star-delta DOL/étoile-delta
3	Discharge pipeline Tubería de descarga Canalisation de décharge	Carbon steel Acero carbono Acier Carbone	11	Pressure Switch Interruptor presión Pressostat	0-16bar 0-16bar 0-16bar	19	Jockey controller Controladora jockey Contrôleur Jockey	DOL DOL DOL
4	Gate Valve Válvula compuerta Robinet-vanne	Ductile Iron Hierro dúctil Fonte ductile	12	Jockey pump Bomba jockey Pompe jockey	Maintain supplier Mantener proveedor Maintenir le fournisseur	20	Diesel controller Controladora diesel Contrôleur diesel	DOL DOL DOL
5	Check Valve La válvula de retención Clapet anti-retour	Ductile Iron Hierro dúctil Fonte ductile	13	Jockey Check Valve Válvula de retención jockey Clapet anti-retour jockey	Brass Latón Laiton	21	Electric pump Bomba eléctrica Pompe électrique	Main supplier Proveedor principal Fournisseur principal
6	Flexible Joint Articulación flexible Joint flexible	Rubber Caucho Caoutchouc	14	Jockey Gate Valve Válvula de compuerta jockey Robinet-vanne jockey	Brass Latón Laiton	22	Batteries Pilas Piles	Main/Standby Principal/En espera Principal/Veille
7	OS&Y valve Válvula OS&Y Vanne OS&Y	Ductile Iron Hierro dúctil Fonte ductile	15	Flexible Joint Articulación flexible Joint flexible	Rubber Caucho Caoutchouc	23	Support rod Barra de soporte Tige de support	Iron Hierro Le fer
8	Relief Valve Válvula de seguridad Soupape de décharge	Brass Latón Laiton	16	Diesel engine Motor diesel Moteur diesel	Internal combustion Combustión interna Combustion interne	24	Base Base Base	Iron Hierro Le fer

PIPE DIAMETERS TABLE/TABLA DE DIÁMETROS TUBERÍA/TABLEAU DES DIAMÈTRES TUYAUX

Pump Flow Rate Caudal de la bomba Débit de la pompe		Minimum Pipe Diameters (Nominal) Diámetros mínimos de tubería(nominal) Diamètres minimum de tuyau(nominal)		Pump Flow Rate Caudal de la bomba Débit de la pompe		Minimum Pipe Diameters (Nominal) Diámetros mínimos de tubería(nominal) Diamètres minimum de tuyau(nominal)	
GPM	m³/h			GPM	m³/h	Suction Succión Succión	Discharge Descarga Décharge
25	6	1"-DN25	1"-DN25	750	170	6"-DN150	6"-DN150
50	11	1 ½"-DN40	1 ¼"-DN32	1000	227	8"-DN200	6"-DN150
100	23	2"-DN50	2"-DN50	1250	284	8"-DN200	8"-DN200
150	34	2 ½"-DN65	2 ½"-DN65	1500	341	8"-DN200	8"-DN200
200	45	3"-DN80	3"-DN80	2000	455	10"-DN250	10"-DN250
250	57	4"-DN100	3"-DN80	2500	568	10"-DN250	10"-DN250
300	68	4"-DN100	4"-DN100	3000	682	12"-DN300	12"-DN300
400	91	4"-DN100	4"-DN100	3500	795	12"-DN300	12"-DN300
450	102	5"-DN125	5"-DN125	4000	909	14"-DN350	12"-DN300
500	114	5"-DN125	5"-DN125	4500	1023	16"-DN400	14"-DN350
				5000	1136	16"-DN400	14"-DN350

SCHEMATIC DIAGRAM OF FIRE PUMP/DIAGRAMA SCHMATIC DE BOMBA CONTRA INCENDIOS/SCHÉMA SCHMATIQUE DE POMPE À INCENDIE

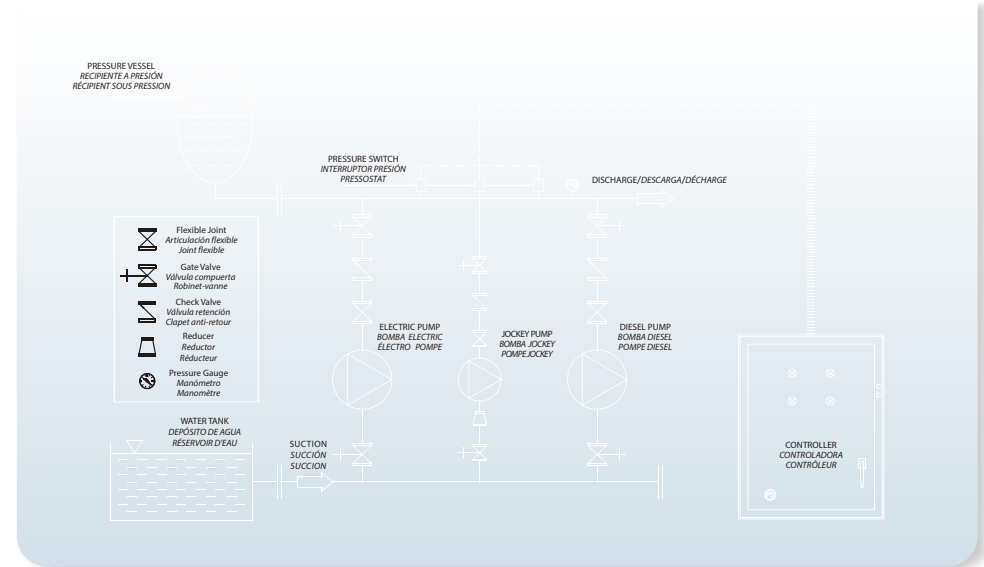

TECHNICAL SHEET/HOJA TÉCNICA/FICHE TECHNIQUE

Model/Modelo/Modèle	PST	
Capacity/Caudal/Débit	0-400	m³/h
Head/Altura/Hauteur	0-151	m
DN	32-125	mm
Speed/Velocidad/Vitesse	2900	rpm
T max	120	°C
Power/Potencia/Puiss.	0.75-160	kW
Voltage/Voltaje/Tension	220/380/400/440	V
HZ	50	
Class/Clase/Classe	Class F/IP 55	
Duty/Servicio/Devoir	S1 continuous	
Casing/Cuerpo/Corps	Grey Cast Iron Hierro fundido gris Fonte grise	
Impeller/Impulsor/Roue	AISI 304/Brass Inox304/Bronce Inox304/Laiton	
Shaft/Eje/Arbre	AISI304 Inox304 Inox304	
Shaft seal/Sello/Scellé	Mechanical Seal Sello mecánico Garniture mécanique	
Bearing/Rodamiento/Palier	Grease lubrication rolling bearing Rodamientos lubricación con grasa Roulement lubrification à la graisse	

Electric/Eléctrico/Électrique

- Electric pump to primarily provide flow and pressure in the system
- Bomba eléctrica para proporcionar principalmente flujo y presión
- Pompe électrique pour fournir principalement le débit et la pression



Close coupled type
Tipo acoplado cerrado
Type à couplage étroit

NEW/NUEVO/NOUVEAU

DESCRIPTION/DESCRIPCIONES/DESCRIPTION

- According to NFPA20, centrifugal pump shall be of the overhung impeller design with close or separate coupled end suction type
- Pump capacities are based on the calculated system demand
- Fire pump shutoff head should not exceed 140% of the nominal value
- Recommended the maximum system demand flow correlate to a point on pump curve between 90% to 140% of the pump capacity
- De acuerdo con NFPA20, bomba centrífuga debe ser del diseño impulsor sobresaliente con tipo succión extremo acoplado cerrado o separado
- Las capacidades de la bomba se basan en la demanda calculada del sistema
- El caudal de cierre de la bomba contra incendios no debe exceder el 140% del valor nominal
- Se recomienda que el flujo máximo de demanda se correlacione con un punto en la curva entre 90% y 140% de la capacidad nominal
- Selon NFPA20, pompe centrifuge doit être du type à roue surplombée avec type d'aspiration à extrémité couplée étroite ou séparée
- Les capacités de la pompe sont basées sur la demande calculée du système
- La tête d'arrêt de la pompe à incendie ne doit pas dépasser 140% de la valeur nominale
- Il est recommandé que le débit maximal de demande soit corrélé à un point sur la courbe entre 90% et 140% de la capacité nominale

MODEL CODE/CÓDIGO MODELO/CODE MODÈLE

For example/ Por ejemplo/ Par exemple

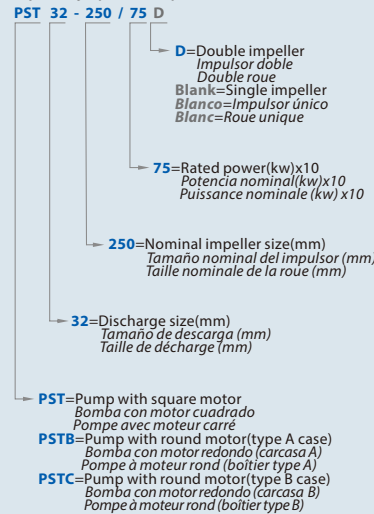

TECHNICAL DATA/DATOS TÉCNICOS/DONNÉES TECHNIQUES

50 Hz n=2900 1/min

	DN	mm	kw	hp	US																
					gpm	0	25	50	75	100	120	150	200	250	300	350	400	450	500	600	
					l/min	0	95	190	283	383	450	567	750	950	1133	1317	1517	1700	1900	2267	
					m³/h	0	5.7	11.4	17	23	27	34	45	57	68	79	91	102	114	136	
PST 32-250/55	50x32	5.5	7.5	60	60	58	52	39	-	-	-	-	-	-	-	-	-	-	-	-	-
PST 32-250/75	50x32	7.5	10	69.5	69.5	68	64	56	-	-	-	-	-	-	-	-	-	-	-	-	-
PST 32-250/92	50x32	9.2	12.5	75	75	73.5	70	61	-	-	-	-	-	-	-	-	-	-	-	-	-
PST 32-250/110	50x32	11	15	90	89	86	80	69	-	-	-	-	-	-	-	-	-	-	-	-	-
PST 32-250/150	50x32	15	20	97	96.8	94	88	76	-	-	-	-	-	-	-	-	-	-	-	-	-
PST 32-250/55D	50x32	5.5	7.5	79.5	76	69	58	42	-	-	-	-	-	-	-	-	-	-	-	-	-
PST 32-250/75D	50x32	7.5	10	95	94	88	78	62	-	-	-	-	-	-	-	-	-	-	-	-	-
PST 40-250/92	65x40	9.2	12.5	64	-	-	60	57	55	51	42	-	-	-	-	-	-	-	-	-	-
PST 40-250/110	65x40	11	15	72	-	-	68	66	63.5	59	50	-	-	-	-	-	-	-	-	-	-
PST 40-250/150	65x40	15	20	84.5	-	-	79.5	77.5	75.2	71.5	63	-	-	-	-	-	-	-	-	-	-
PST 40-250/185	65x40	18.5	25	90	-	-	86	83.5	80.7	77	68	-	-	-	-	-	-	-	-	-	-
PST 50-250/150	65x50	15	20	68.5	-	-	-	-	-	65	62	58	53	45	-	-	-	-	-	-	-
PST 50-250/185	65x50	18.5	25	79	-	-	-	-	-	77	74	71	66	59	47	-	-	-	-	-	-
PST 50-250/220	65x50	22	30	89.5	-	-	-	-	-	88	85	81.5	76	68	57	-	-	-	-	-	-
PST 65-250/220	80x65	22	30	64.8	-	-	-	-	-	-	-	63.5	62	61	58.5	56	52.5	-	-	-	-
PST 65-250/300	80x65	30	40	80	-	-	-	-	-	-	-	79	78	77	74.5	72	70	59	-	-	-
PST 65-250/370	80x65	37	50	92	-	-	-	-	-	-	-	89.5	88.5	87	85	83	80	69	-	-	-

	DN	mm	kw	hp	US															
					gpm	0	250	400	500	600	750	850	950	1000	1250	1350	1500	1750		
					l/min	0	950	1517	1900	2267	2833	3217	3600	3783	4733	5100	5683	6617		
					m³/h	0	57	91	114	136	170	193	216	227	284	306	341	397		
PST 65-315/450	80x65	45	60	102	98	94.5	90	83	-	-	-	-	-	-	-	-	-	-	-	-
PST 65-315/550	80x65	55	75	122	120	114.5	111	104	85	-	-	-	-	-	-	-	-	-	-	-
PST 65-315/750	80x65	75	100	141	141	134.5	132	123	105	86	64	-	-	-	-	-	-	-	-	-
PST 65-315/900	80x65	90	125	151	150	144.5	141	133	115	95	74	-	-	-	-	-	-	-	-	-
PST 80-250/370	100x80	37	50	71.5	70.9	70.5	66	62	54	46	37	-	-	-	-	-	-	-	-	-
PST 80-250/450	100x80	45	60	88	86.7	86	84	80	72	62	49	-	-	-	-	-	-	-	-	-
PST 80-250/550	100x80	55	75	94.5	94.5	94.5	92	89	82	76	66	-	-	-	-	-	-	-	-	-
PST 80-315/450	100x80	45	60	85	84	82.6	82	78	72	64	52	-	-	-	-	-	-	-	-	-
PST 80-315/550	100x80	55	75	98	97	95.6	95	92	86	78	67	-	-	-	-	-	-	-	-	-
PST 80-315/750	100x80	75	100	124	123	121.6	119	116	110	103	94.5	89	-	-	-	-	-	-	-	-
PST 80-315/900	100x80	90	125	144	143	141.6	140	137	130	122	114	108	-	-	-	-	-	-	-	-
PST 100-250/450	125x100	45	60	65	65	64	63	62	58.5	56	53	51	39	33.5	-	-	-	-	-	-
PST 100-250/550	125x100	55	75	77	76	75.5	76	75	73	72	70	70	62.3	59	-	-	-	-	-	-
PST 100-250/750	125x100	75	100	91	91	90.5	89.7	88	86	84	82	81	71.7	68.5	56	-	-	-	-	-
PST 100-250/900	125x100	90	125	100	100	99.5	98	97	95	93	91	90	80.7	77.5	65	-	-	-	-	-
PST 100-315/750	125x100	75	100	80	-	-	78	78	76	74	73	72	66	64	56	-	-	-	-	-
PST 100-315/900	125x100	90	125	100	-	-	98	98	96	94	93	92	86	84	77	-	-	-	-	-
PST 100-315/1100	125x100	110	150	118	-	-	116	115.5	114	112	111	110	104	102	95	-	-	-	-	-
PST 100-315/1320	125x100	132	180	129	-	-	127	126	124	123	122	121	115	112	105	-	-	-	-	-
PST 100-315/1600	125x100	160	220	148	-	-	146	145	144	142	141	140	134	132	125	-	-	-	-	-
PST 125-250/550	150x125	55	75	70	-	-	67	66.5	65	63.5	61.5	60.5	54	50.5	-	-	-	-	-	-
PST 125-250/750	150x125	75	100	80	-	-	77	76	74.5	73	72	71	67	65	60	-	-	-	-	-
PST 125-250/900	150x125	90	125	87	-	-	84	83	81.5	80	78.5	78	73.5	71.5	67.5	60	-	-	-	-

TECHNICAL SHEET/HOJA TÉCNICA/FICHE TECHNIQUE

Model/Modelo/Modèle	PV	
Capacity/Caudal/Débit	0-48	m ³ /h
Head/Altura/Hauteur	0-176	m
DN	25-65	mm
Speed/Velocidad/Vitesse	2900	rpm
T max	120	°C
Power/Potencia/Puiss.	1.1-11	kW
Voltage/Voltaje/Tension	220/380/400/440 V	
HZ	50	
Class/Clase/Classe	Class F/IP 55	
Duty/Servicio/Devoir	S1 continuous	
Casing/Cuerpo/Corps	Grey Cast Iron Hierro fundido gris Fonte grise	
Impeller/Impulsor/Roue	Plastic Plástico Plastique	
Shaft/Eje/Arbre	AISI304 Inox304 Inox304	
Shaft seal/Sello/Scellé	Mechanical Seal Sello mecánico Garniture mécanique	
Bearing/Rodamiento/Palier	Grease lubrication rolling bearing Rodamientos lubricación con grasa Roulement lubrification à la graisse	

Jockey/Jockey/Jockey

 The jockey pump is designed to maintain the necessary pressure in the system

 Bomba jockey para mantener la presión necesaria en el sistema

 Pompe jockey pour maintenir la pression nécessaire dans le système



Plastic impeller type
Tipo impulsor plástico
Type roue en plastique

TECHNICAL SHEET/HOJA TÉCNICA/FICHE TECHNIQUE

Model/Modelo/Modèle	PVT/S	
Capacity/Caudal/Débit	0-110	m ³ /h
Head/Altura/Hauteur	0-305	m
DN	25-100	mm
Speed/Velocidad/Vitesse	2900	rpm
T max	120	°C
Power/Potencia/Puiss.	0.37-45	kW
Voltage/Voltaje/Tension	220/380/400/440 V	
HZ	50	
Class/Clase/Classe	Class F/IP 55	
Duty/Servicio/Devoir	S1 continuous	
Casing/Cuerpo/Corps	Grey Cast Iron Hierro fundido gris Fonte grise	
Impeller/Impulsor/Roue	AISI304 Inox304 Inox304	
Shaft/Eje/Arbre	AISI304 Inox304 Inox304	
Shaft seal/Sello/Scellé	Mechanical Seal Sello mecánico Garniture mécanique	
Bearing/Rodamiento/Palier	Grease lubrication rolling bearing Rodamientos lubricación con grasa Roulement lubrification à la graisse	

Jockey/Jockey/Jockey

 The jockey pump is designed to maintain the necessary pressure in the system

 Bomba jockey para mantener la presión necesaria en el sistema



 Pompe jockey pour maintenir la pression nécessaire dans le système



SS304 impeller type
Tipo impulsor inox
Type de roue inox

NEW/NUEVO/NOUVEAU

DESCRIPTION/DESCRIPCIONES/DESCRIPTION

-  The jockey pump is designed to maintain the pressure on the fire protection system between preset limits when the system is not flowing water.
- Rated capacity not less than any normal leakage rate.
- Discharge pressure sufficient to maintain the desired fire protection system pressure.
- YE3 high efficient motor, with protection IP55 class F
-  La bomba jockey está diseñada para mantener la presión sobre los sistemas de protección contra incendios entre los límites preestablecidos cuando el sistema no fluye agua
- Tener una capacidad nominal no menor que cualquier tasa de fuga normal
- Tener una presión de descarga suficiente para mantener la presión deseada del sistema de protección contra incendios
- Motor de alta eficiencia YE3, con protección IP55 clase F
-  La pompe jockey est conçue pour maintenir la pression sur le (s) système (s) de protection contre les incendies entre les limites prédéfinies lorsque le système ne coule pas.
- Capacité nominale non inférieure à tout taux de fuite normal.
- Pression de décharge suffisante pour maintenir la pression souhaitée du système de protection contre les incendies.
- Moteur haute efficacité YE3, avec protection IP55 classe F

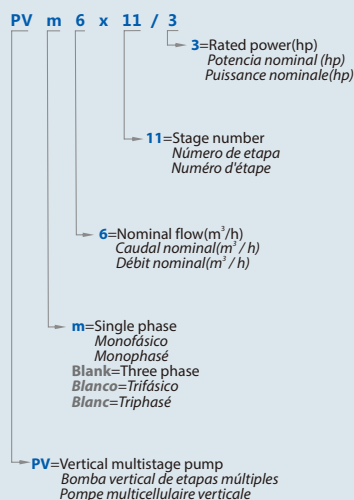

MODEL CODE/CÓDIGO MODELO/CODE MODÈLE

For example/Por ejemplo/Par exemple



NEW/NUEVO/NOUVEAU

DESCRIPTION/DESCRIPCIONES/DESCRIPTION

-  The jockey pump is designed to maintain the pressure on the fire protection system between preset limits when the system is not flowing water.
- Rated capacity not less than any normal leakage rate.
- Discharge pressure sufficient to maintain the desired fire protection system pressure.
- YE3 high efficient motor, with protection IP55 class F
-  La bomba jockey está diseñada para mantener la presión sobre los sistemas de protección contra incendios entre los límites preestablecidos cuando el sistema no fluye agua
- Tener una capacidad nominal no menor que cualquier tasa de fuga normal
- Tener una presión de descarga suficiente para mantener la presión deseada del sistema de protección contra incendios
- Motor de alta eficiencia YE3, con protección IP55 clase F
-  La pompe jockey est conçue pour maintenir la pression sur le (s) système (s) de protection contre les incendies entre les limites prédéfinies lorsque le système ne coule pas.
- Capacité nominale non inférieure à tout taux de fuite normal.
- Pression de décharge suffisante pour maintenir la pression souhaitée du système de protection contre les incendies.
- Moteur haute efficacité YE3, avec protection IP55 classe F

MODEL CODE/CÓDIGO MODELO/CODE MODÈLE

For example/Por ejemplo/Par exemple

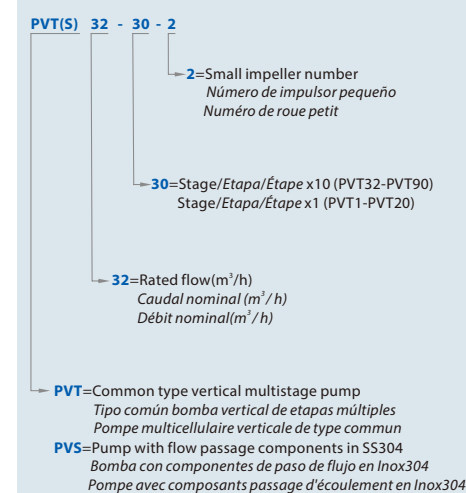

NEW/NUEVO/NOUVEAU

DESCRIPTION/DESCRIPCIONES/DESCRIPTION

- ◆ Equipped with **Smartgen** display screen, integrates digitalization, intellectualization and network technologies for precise data measurement, alarm protection, remote control, measuring and communication
 - ◆ DOL or Star Delta starter
 - ◆ All controllers completely assembled, wired, and tested
 - ◆ Self-acting to start, run, and protect the driver
 - ◆ Automatic or manual operation options
- ◆ Equipado con una pantalla de visualización **Smartgen**, se integra con las tecnologías de digitalización, intelectualización y red para la medición precisa de datos, protección de alarmas, control remoto, medición y comunicación
 - ◆ DOL o Star Delta starter
 - ◆ Todos los controladores completamente cableados y probados
 - ◆ De acción automática para iniciar, ejecutar y proteger al conductor
 - ◆ Opciones de operación automática o manual
- ◆ Équipé d'un écran d'affichage **Smartgen**, s'intègre aux technologies de numérisation, d'intellectualisation et de réseau pour la mesure précise des données, la protection des alarmes, la télécommande, la mesure et la communication
 - ◆ Démarreur DOL ou Star Delta
 - ◆ Tous les contrôleurs sont complètement assemblés, câblés et testés
 - ◆ Agit automatiquement pour démarrer, exécuter et protéger le conducteur
 - ◆ Options de fonctionnement automatique ou manuel

Controller/Controladora /Contrôleur

- ◆ Fire pump controllers are used to monitor and to start and stop fire pumps
- ◆ Los controladores se utilizan para monitorear y para iniciar y detener bombas
- ◆ Les contrôleurs sont utilisés pour surveiller et pour démarrer et arrêter les pompes



PVK

Jockey+Tank system Sistema de Jockey+Tanque Système Jockey + Tank



OTHER ACCESSORIES/OTROS ACCESORIOS/AUTRES ACCESSOIRES

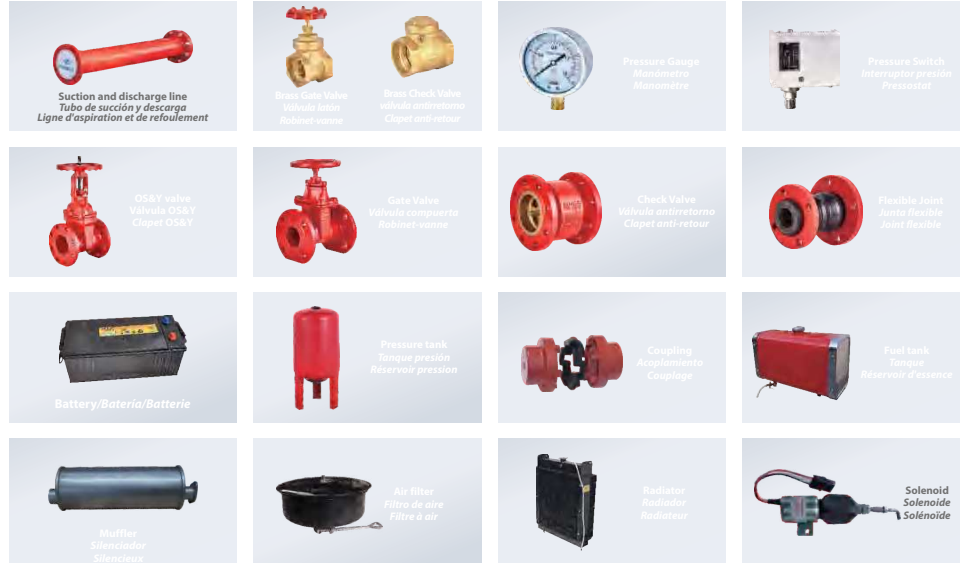

NEW/NUEVO/NOUVEAU

DESCRIPTION/DESCRIPCIONES/DESCRIPTION

- ◆ New jockey+tank system design
 - ◆ Original design by PURITY
 - ◆ YE3 high efficient motor, with protection IP55 class F
 - ◆ Pump case with anti-corrosive coating
 - ◆ Impeller in techno-polimer
 - ◆ Shaft in stainless steel AISI 304 or galvanized iron
 - ◆ Quality NSK bearing, wear resistance mechanical seal
- ◆ Nueva diseño de sistema de jockey+tanque
 - ◆ Diseño original de PURITY (Patentado)
 - ◆ Motor de eficiencia YE3 con Protección IP55 clase F
 - ◆ Cuerpo de bomba con tratamiento anti-corrosión
 - ◆ Impulsor en tecnopolímero
 - ◆ Eje de la bomba en inox AISI304 o hierro galvanizado
 - ◆ Rodamiento de marca NSK y cierre mecánico personalizado
- ◆ Nouvelle conception du système jockey + tank
 - ◆ Design original par PURITY
 - ◆ Moteur haute efficacité YE3, avec protection IP55 classe F
 - ◆ Boîtier de pompe avec revêtement anti-corrosif
 - ◆ Turbine en techno-polimer
 - ◆ Arbre en acier inoxydable AISI 304 ou en fer galvanisé
 - ◆ Roulement NSK de qualité, joint mécanique résistance à l'usure

USING LIMITS/LÍMITES UTILIZACIÓN/UTILISATION LIMITES

- ◆ Liquid temperature between **-10°C** and **+120°C**
 - ◆ Ambient temperature between **-10°C** and **+50°C**
 - ◆ Max. working pressure **25 bar**
 - ◆ Continuous service **S1**
- ◆ Temperatura del líquido de **-10 °C** hasta **+120 °C**
 - ◆ Temperatura ambiente de **-10 °C** hasta **+50 °C**
 - ◆ Presión máxima en el cuerpo de la bomba **25 bar**
 - ◆ Funcionamiento continuo **S1**
- ◆ Température du liquide entre **-10 °C** et **+120 °C**
 - ◆ Température ambiante entre **-10 °C** et **+50 °C**
 - ◆ Max. pression de service **25 bar**
 - ◆ Service continu **S1**

TECHNICAL DATA/DATOS TÉCNICOS/DONNÉES TECHNIQUES

Model Modelo Modèle	Flow Caudal Débit	Head Altura Hauteur	Power Potencia Puissance	Jockey Jockey Jockey	Tank Tanque Réservoir
	GPM	Bar	hp		L
PVK25/3	25	6	3	PV 6×11/3	60
PVK35/4	35	7	4	PV 8×12/4	60
PVK50/5.5	50	7	5.5	PV 12×12/5.5	60
PVK60/7.5	60	7	7.5	PV 12×17/7.5	60
PVK100/10	100	8	10	PV 30×7/10	100
PVK125/12	125	8	12	PV 30×9/12	100
PVK150/15	150	8	15	PV 30×11/15	100



PTD

Inline circulation pump

Bomba de circulación en línea

Pompe de circulation en ligne

NEW/NUEVO/NOUVEAU

DESCRIPTION/DESCRIPCIONES/DESCRIPTION

- ◆ Single-stage centrifugal pumps in inline design
 - ◆ With high temperature seal for using in heating systems
 - ◆ Easily back pull-out from motor for coupling design
 - ◆ YE3 high efficient motor, with protection IP55 class F
 - ◆ Pump case with anti-corrosive coating
 - ◆ Shaft in stainless steel AISI 304
 - ◆ Quality NSK bearing, wear resistance mechanical seal
- ◆ Bombas centrifugas de una etapa en diseño en línea.
 - ◆ Con cierre de alta temperatura para sistemas calefacción
 - ◆ Extracción fácil del motor para el diseño del acoplamiento
 - ◆ Motor de alta eficiencia YE3, con protección IP55 clase F
 - ◆ Caja de bomba con revestimiento anticorrosivo
 - ◆ Eje en acero inoxidable 304
 - ◆ Rodamiento de marca NSK y cierre mecánico personalizado
- ◆ Pompes centrifuges à un étage de conception en ligne
 - ◆ Avec garniture haute température pour les systèmes chauffage
 - ◆ Retrait facile du moteur pour la conception de l'accouplement
 - ◆ Moteur haute efficacité YE3, avec protection IP55 classe F
 - ◆ Boîtier de pompe avec revêtement anti-corrosif
 - ◆ Arbre en acier inoxydable 304
 - ◆ Roulement NSK qualité, joint mécanique de résistance à l'usure

USING LIMITS/LÍMITES UTILIZACIÓN/UTILISATION LIMITES

- ◆ Ambient temperature between **-10°C** and **+50°C**
 - ◆ Max. working pressure **16 bar/Continuos S1**
- ◆ Temperatura del líquido de **-10 °C** hasta **+120 °C**
 - ◆ Temperatura ambiente de **-10 °C** hasta **+50 °C**
 - ◆ Presión máxima **16 bar/Continuo S1**
- ◆ Température du liquide entre **-10 °C** et **+120 °C**
 - ◆ Température ambiante entre **-10 °C** et **+50 °C**
 - ◆ Max. pression de service **16 bar/Continu S1**

MODEL CODE/CÓDIGO MODELO/CODE MODÈLE

For example/Par ejemplo/Par exemple

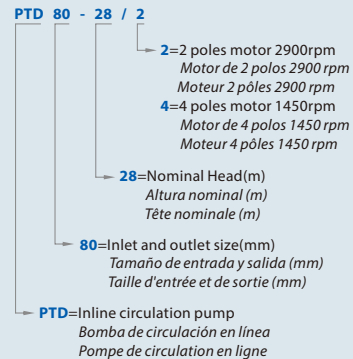

MATERIAL DESCRIPTION/DESCRIPCIÓN DE MATERIAL/DESCRIPTION DU MATÉRIEL

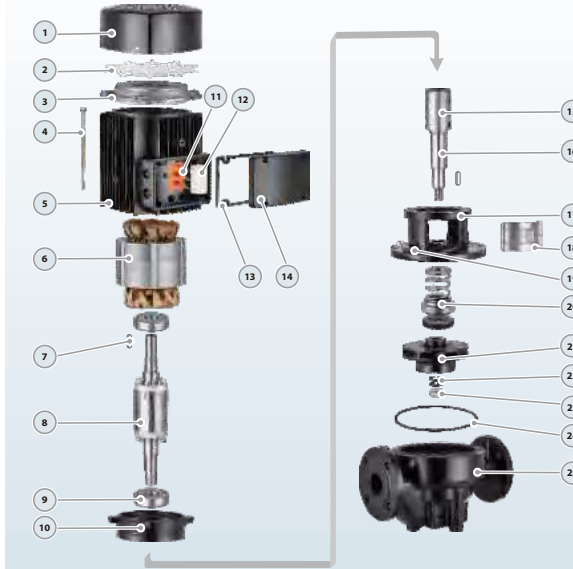

No.	Description Descripción Description	Material Material Matériel
1	Fan Cover Tapa/Capot	Aluminum Aluminio/Aluminium
2	Fan Ventilador/Ventilateur	Plastic Plástico/Plastique
3	Back cover Tapa Trasera/Capot Arrière	Cast iron Fundición/Fonte
4	Through Bolt Perno/Boulon	Steel Acero/Acier
5	Motor Case Cuerpo Motor/Boîtier Moteur	Aluminum Aluminio/Aluminium
6	Wound Stator Estator/Stator	Silicon-copper Silicio-Cobre/Silicium-Cuivre
7	Impeller Key Chaveta/Clé	Iron Hierro/Le fer
8	Rotor Rotor/Rotor	Acero Silicio/Acier Silicium
9	Bearing Rodamiento/Palier	Ball Bearing Bola Rodamiento/Palier Balle
10	Motor Cover Tapa Motor/Capot Moteur	Cast iron Fundición/Fonte
11	Terminal Board Tablero Bornas/Bornier	Plastic Plástico/Plastique
12	Capacitor Capacitor/Condensateur	Plastic Plástico/Plastique
13	Pad Almohadilla/Tampon	Rubber Caucho/Caoutchouc
14	Terminal Box Caja Bornas/Boite Bornes	Aluminum Aluminio/Aluminium
15	Coupling Unión/Couplage	Steel Acero/Acier
16	Shaft Eje/Arbre	Inox 304/Inox 304
17	Connection Conexión/Lien	Cast iron Fundición/Fonte
18	Case Cover Tapa Cuerpo/Capot Boîtier	SS304 Inox 304/Inox 304
19	Release Valve Tapón Cebador/Valve Purge	Brass Bronce/Laiton
20	Mechanical Seal Cierre Mecánica/Sceller	SiC-Carbon Silicio-Grafita/Silicium-Carbon
21	Impeller Impulsor/Roue	Cast iron Fundición/Fonte
22	Washer Arandela/Rondelle	Steel Acero/Acier
23	Impeller Nut Nuez/Noix	Galvanized Steel Acero Galvanizado/Acier Galvanisé
24	O-ring Junta Torióncar/Joint Torique	Rubber Caucho/Caoutchouc
25	Pump Case Cuerpo/Boîtier	Cast iron Fundición/Fonte

DIMENSIONS AND WEIGHT/DIMENSIONES Y PESOS/DIMENSIONS ET POIDS

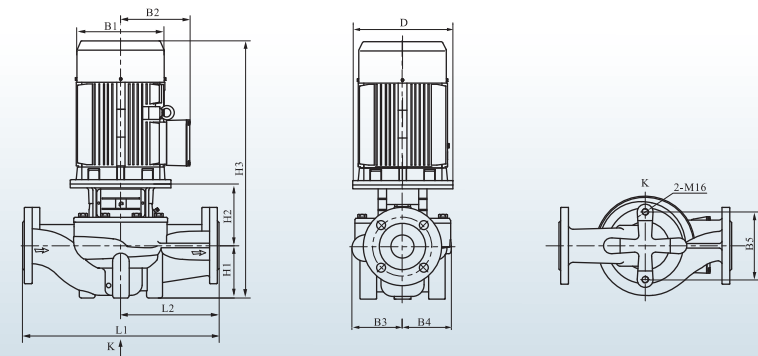

DIMENSIONS AND WEIGHT/DIMENSIONES Y PESOS/DIMENSIONS ET POIDS

MODEL MODELO MODÈLE	Q m³/h	H m	P kW	RPM	DIMENSIONS/DIMENSIONES/DIMENSIONS mm												KG
					D	B1	B2	B3	B4	B5	H1	H2	H3	L1	L2		
PTD32-18/2	8	18	1.1	3000	120	170	142	125	117	144	100	166	511	340	170	50	
PTD32-21/2	12.5	21	1.5	3000	140	190	155	125	117	144	100	166	556	340	170	56	
PTD32-25/2	12.5	25	2.2	3000	140	190	155	125	117	144	100	166	556	340	170	59	
PTD32-32/2	12.5	32	3	3000	160	197	165	125	117	144	100	185	630	340	170	68	
PTD32-38/2	12.5	38	4	3000	160	230	188	144	144	144	100	185	640	440	220	79	
PTD32-50/2	12.5	50	5.5	3000	220	260	208	144	144	144	100	213	703	440	220	104	
PTD40-16/2	12.5	16	1.1	3000	120	170	142	97	96	120	68	150	463	320	160	40	
PTD40-20/2	12.5	20	1.5	3000	140	190	155	97	96	120	68	160	518	320	160	46	
PTD40-18/2	20	18	2.2	3000	140	190	155	110	95	144	100	167	557	340	170	53	
PTD40-25/2	20	25	3	3000	160	197	165	127	115	144	100	185	630	340	170	70	
PTD40-30/2	25	30	4	3000	160	230	188	127	115	144	100	185	540	340	170	77	
PTD40-36/2	25	36	5.5	3000	200	260	208	138	125	144	110	213	713	440	220	106	
PTD40-48/2	25	48	7.5	3000	200	260	208	138	125	144	110	213	713	440	220	110	
PTD50-12/2	16	12	1.1	3000	120	170	142	117	115	144	115	153	513	340	170	56	
PTD50-15/2	20	15	1.5	3000	140	190	155	117	115	144	115	153	558	340	170	62	
PTD50-18/2	25	18	2.2	3000	140	190	155	117	115	144	115	153	558	340	170	55	
PTD50-24/2	25	24	3	3000	160	197	165	117	115	144	115	172	632	340	170	74	
PTD50-28/2	30	28	4	3000	160	230	188	129	115	144	115	175	645	340	170	79	
PTD50-32/2	12.5	32	3	3000	160	197	165	128	128	144	105	162	612	400	200	65	
PTD50-35/2	30	35	5.5	3000	200	260	208	129	115	144	115	197	702	340	170	103	
PTD50-38/2	12.5	38	4	3000	160	230	188	128	128	144	105	162	622	400	200	71	
PTD50-40/2	35	40	7.5	3000	200	260	208	171	158	144	115	187	692	440	220	118	
PTD50-48/2	12.5	48	5.5	3000	200	260	208	128	128	144	105	186	681	400	200	85	
PTD50-50/2	40	50	11	3000	350	330	255	171	158	144	115	150	865	440	220	181	
PTD50-58/2	12.5	58	7.5	3000	200	260	208	163	163	144	105	196	691	440	220	110	
PTD50-60/2	50	60	15	3000	350	330	255	171	158	144	115	250	865	440	220	191	
PTD50-70/2	50	70	18.5	3000	350	330	255	171	158	144	115	250	915	440	220	209	
PTD50-80/2	12.5	80	11	3000	350	330	255	163	163	144	105	196	801	440	220	185	
PTD50-81/2	50	81	22	3000	350	360	285	171	158	144	115	250	940	440	220	245	
PTD65-15/2	30	15	2.2	3000	140	190	155	142	124	144	105	172	567	360	180	65	
PTD65-19/2	30	19	3	3000	160	197	165	142	124	144	105	191	641	360	180	74	
PTD65-22/2	40	22	4	3000	160	230	188	142	124	144	105	191	651	360	180	81	
PTD65-30/2	40	30	5.5	3000	200	260	208	142	124	144	105	213	708	360	180	105	
PTD65-34/2	50	34	7.5	3000	200	260	208	142	124	144	105	213	708	360	180	108	
PTD65-36/2	25	36	5.5	3000	200	260	208	128	128	144	105	194	689	400	200	87	
PTD65-40/2	50	40	11	3000	350	330	255	179	167	144	125	262	887	470	238	183	
PTD65-48/2	25	48	7.5	3000	200	260	208	128	128	144	105	194	689	400	200	91	
PTD65-50/2	50	50	15	3000	350	330	255	179	167	144	125	262	887	475	238	193	
PTD65-61/2	50	61	18.5	3000	350	330	255	179	167	144	125	262	937	475	238	210	
PTD65-67/2	50	67	22	3000	350	330	255	179	167	144	125	262	962	475	238	248	
PTD65-83/2	50	83	30	3000	400	400	310	142	167	144	125	262	1037	475	238	309	
PTD80-13/2	50	13	3	3000	160	197	165	142	124	160	97	219	661	450	225	84	
PTD80-18/2	50	18	4	3000	160	230	188	142	124	160	97	219	671	450	225	91	
PTD80-22/2	50	22	5.5	3000	200	260	208	142	124	160	97	241	728	450	225	114	
PTD80-28/2	50	28	7.5	3000	200	260	208	142	124	160	97	241	728	450	225	117	
PTD80-30/2	80	30	11	3000	350	330	255	182	163	144	115	279	894	500	250	194	
PTD80-38/2	80	38	15	3000	350	330	255	182	163	144	115	279	894	500	250	204	
PTD80-40/2	50	40	11	3000	350	330	255	137	128	144	115	240	855	500	250	170	
PTD80-47/2	80	47	18.5	3000	350	330	255	182	163	144	115	279	944	500	250	222	
PTD80-48/2	50	48	15	3000	350	330	255	137	128	144	115	240	855	500	250	181	
PTD80-54/2	80	54	22	3000	350	330	255	182	163	144	115	279	969	500	250	258	
PTD80-67/2	80	67	30	3000	400	400	310	182	163	144	115	279	1044	500	250	319	
PTD100-9/2	50	9	2.2	3000	140	175	155	134	101	160	105	178	573	450	225	65	
PTD100-15/2	60	15	4	3000	160	215	190	134	101	160	105	190	650	450	225	83	
PTD100-17/2	80	17	5.5	3000	200	260	205	150	117	144	140	215	745	500	250	119	
PTD100-22/2	80	22	7.5	3000	200	260	205	150	117	144	140	215	745	500	250	122	

DIMENSIONS AND WEIGHT/DIMENSIONES Y PESOS/DIMENSIONS ET POIDS

MODEL MODELO MODÈLE	Q m³/h	H m	P kW	RPM	DIMENSIONS/DIMENSIONES/DIMENSIONS mm												KG
					D	B1	B2	B3	B4	B5	H1	H2	H3	L1	L2		
PTD100-25/2	100	25	11	3000	350	350	245	147	123	144	140	260	900	550	275	175	
PTD100-27/2	100	27	11	3000	350	350	245	147	123	144	140	260	900	550	275	183	
PTD100-32/2	100	32	15	3000	350	350	265	147	123	144	140	260	900	550	275	189	
PTD100-33/2	100	33	15	3000	350	350	265	147	123	144	140	260	900	550	275	194	
PTD100-40/2	100	40	18.5	3000	350	350	265	181	152	230	140	270	960	550	275	224	
PTD100-48/2	100	48	22	3000	350	350	280	181	152	230	140	270	985	550	275	260	
PTD100-52/2	130	52	30	3000	400	400	305	181	152	230	140	270	1060	550	275	318	
PTD125-11/4	120	11	5.5	1500	200	260	208	216	176	230	215	228	873	620	310	166	
PTD125-14/4	120	14	7.5	1500	200	330	208	216	176	230	215	228	873	620	310	179	
PTD125-18/4	160	18	11	1500	350	330	255	211	177	230	215	276	989	800	400	257	
PTD125-20/4	120	20	11	1500	350	330	255	236	208	230	215	276	1012	800	400	289	
PTD125-22/4	160	22	15	1500	350	330	255	236	208	230	215	292	1047	800	400	302	
PTD125-28/4	160	28	18.5	1500	350	330	255	236	208	230	215	292	1084	800	400	321	
PTD125-32/4	160	32	22	1500	350	330	255	236	208	230	215	292	1122	800	400	356	
PTD125-40/4	160	40	30	1500	400	400	310	272	248	230	215	315	1179	800	400	442	
PTD125-48/4	160	48	37	1500	450	450	325	272	248	230	215	315	1204	800	400	498	
PTD125-50/4	160	50	45	1500	450	450	325	272	248	230	215	315	1311	800	400	505	
PTD150-12.5/4	200	12.5	11	1500	350	315	250	217	180	230	215	272	1003	800	400	275	
PTD150-15/4	200	15	11	1500	350	315	250	217	180	230	215	272	1022	800	400	277	
PTD150-17/4	200	17	15	1500	350	315	250	217	180	230	215	272	1045	800	400	278	
PTD150-18/4	200	18	15	1500	350	315	250	217	180	230	215	272	1065	800	400	285	
PTD150-20/4	220	20	18.5	1500	350	315	250	217	180	230	215	272	1079	800	400	300	
PTD150-21/4	200	21	18.5	1500	350	360	275	217	180	230	215	272	1082	800	400	313	
PTD150-25/4	200	25	22	1500	350	360	275	238	208	230	215	269	1099	800	400	354	
PTD150-33/4	200	33	30	1500	400												



PW

Same port centrifugal pump
Bomba centrífuga misma puerto
Pompe centrifuge même port



NEW/NUEVO/NOUVEAU

DESCRIPTION/DESCRIPCIONES/DESCRIPTION

- ◆ New same DN centrifugal pump
 - ◆ Original design by PURITY (Patent no.201530478502.0)
 - ◆ Both square motor & round motor available
 - ◆ YE3 high efficient motor, with protection IP55 class F
 - ◆ Pump case with anti-corrosive coating
 - ◆ Galvanized counter flange with bolts, nuts and gaskets
 - ◆ Quality NSK bearing, wear resistance mechanical seal
-
- ◆ Nuevas bomba centrífuga misma DN
 - ◆ Diseño original de PURITY (Patente no.201530478502.0)
 - ◆ Motor redondo y cuadrado disponible
 - ◆ Motor de eficiencia YE3 con Protección IP55 clase F
 - ◆ Cuerpo de bomba con tratamiento anti-corrosión
 - ◆ Contrabridas galvanizadas con pernos, tuercas y empaques
 - ◆ Rodamiento de marca NSK y cierre mecánico personalizado
-
- ◆ Nouvelle pompe centrifuge même DN
 - ◆ Design original par PURITY (Brevet no.201530478502.0)
 - ◆ Moteur carré et moteur rond disponibles
 - ◆ Moteur haute efficacité YE3, avec protection IP55 classe F
 - ◆ Boîtier de pompe avec revêtement anti-corrosif
 - ◆ Contre-bride galvanisée avec boulons, écrous et joints
 - ◆ Roulement NSK qualité, joint mécanique de résistance à l'usure

USING LIMITS/LÍMITES UTILIZACIÓN/UTILISATION LIMITES

- ◆ Ambient temperature between 0°C and +50°C
- ◆ Max. working pressure 16 bar/Continuous S1
- ◆ Temperatura del líquido de -10 °C hasta +120 °C
- ◆ Temperatura ambiente de 0 °C hasta +50 °C
- ◆ Presión máxima 16 bar/Continuo S1
- ◆ Température du liquide entre -10 °C et +120 °C
- ◆ Température ambiante entre 0 °C et +50 °C
- ◆ Max. pression de service 16 bar/Continu S1

MODEL CODE/CÓDIGO MODELO/CODE MODÈLE

For example/Par ejemplo/Par exemple

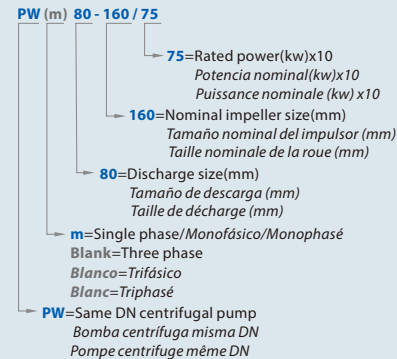

TECHNICAL DATA/DATOS TÉCNICOS/DONNÉES TECHNIQUES

50 Hz n=2900 1/min

MODEL MODELO MODÈLE	DN mm	Power Potencia Puissance		/min m³/h	Q=DELIVERY/CAUDAL/DÉBIT															
		kw	hp		100	150	250	300	400	450	600	700	800	900	1200	1400	1500	1800	2000	2300
		6	9		15	18	24	27	36	42	48	54	72	84	90	108	120	138		
					H=Head/Altura/Hauteur(m)															
PW 80-125/22	80x80	2.2	3	17	-	-	-	-	-	-	15.4	14	12.8	11.5	6.5	-	-	-	-	
PW 80-125/30	80x80	3	4	20	-	-	-	-	-	-	18.8	18	17	15.6	11	-	-	-	-	
PW 80-125/40	80x80	4	5.5	24	-	-	-	-	-	-	23.1	23	21.5	20.3	15.8	11.8	-	-	-	
PW 80-160/55	80x80	5.5	7.5	32	-	-	-	-	-	-	30.6	30	28	26.6	20.5	14.8	-	-	-	
PW 80-160/75	80x80	7.5	10	40	-	-	-	-	-	-	38	37	36	34.4	29	24	21	-	-	
PW 80-200/92	80x80	9.2	12.5	50.5	-	-	-	-	-	-	46.8	45	43	40.9	32.5	25.7	-	-	-	
PW 80-200/110	80x80	11	15	57.5	-	-	-	-	-	-	53.5	52	50	47.5	40	33	29	-	-	
PW 80-250/150	80x80	15	20	68.5	-	-	-	-	-	-	64	63	61.5	59	50	41	-	-	-	
PW 80-250/185	80x80	18.5	25	79	-	-	-	-	-	-	75.8	74.8	74	71.5	63.5	55.5	47	-	-	
PW 80-250/220	80x80	22	30	89.5	-	-	-	-	-	-	86	85.3	84	81.5	73.5	65.5	57	-	-	
PW 100-125/40	100x100	4	5.5	19	-	-	-	-	-	-	-	-	17.3	16.8	14.5	13	11.8	-	-	
PW 100-125/55	100x100	5.5	7.5	23	-	-	-	-	-	-	-	-	21.3	20.9	19	17.5	16.7	13.7	-	
PW 100-125/75	100x100	7.5	10	27	-	-	-	-	-	-	-	-	26	25.6	24.5	23	22.5	20	18	
PW 100-160/92	100x100	9.2	12.5	33	-	-	-	-	-	-	-	-	31.5	30	28	27.1	24	21.5	-	
PW 100-160/110	100x100	11	15	36	-	-	-	-	-	-	-	-	34.5	33	31.5	30.8	28	25.5	-	
PW 100-160/150	100x100	15	20	42	-	-	-	-	-	-	-	-	41	40	38.5	37.8	35	33	29.5	
PW 100-200/150	100x100	15	20	45	-	-	-	-	-	-	-	-	45.5	43	41	40.2	36.5	34	-	
PW 100-200/185	100x100	18.5	25	52	-	-	-	-	-	-	-	-	52.3	51	49	48.2	44.5	42	-	
PW 100-200/220	100x100	22	30	59	-	-	-	-	-	-	-	-	59.5	58	56	55	52	49.5	44.5	

MATERIAL DESCRIPTION/DESCRIPCIÓN DE MATERIAL/DESCRIPTION DU MATÉRIEL

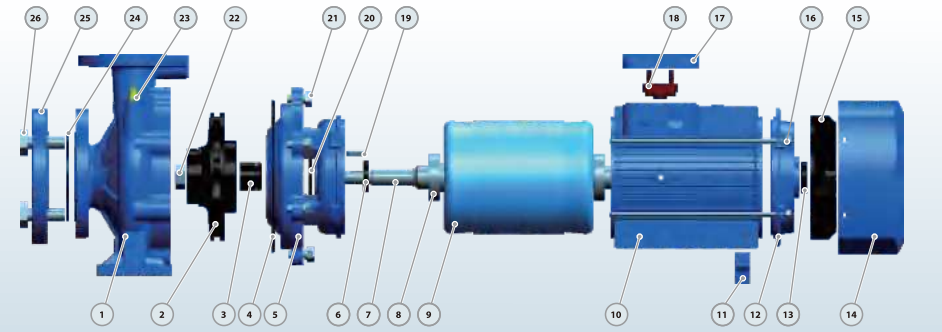

No.	Description Descripción Description	Material Material Matériel	No.	Description Descripción Description	Material Material Matériel	No.	Description Descripción Description	Material Material Matériel
1	Pump Case Cuerpo/Boitier	Cast iron Fundición/Fonte	10	Motor Case Cuerpo Motor/Boitier Moteur	Aluminum Aluminio/Aluminium	19	Impeller Key Chaveta/Clé	Iron Hierro/Le fer
2	Impeller Impulsor/Roue	Cast iron Fundición/Fonte	11	Support Foot Soporte Pie/Pied support	Plastic Plástico/Plastique	20	Water Deflector Deflector/Deflecteur	Rubber Caucho/Caoutchouc
3	Mechanical Seal Cierre Mecánico/Sceller	SiC-Carbon Silicio-Grafito/Silicium-Carbon	12	Back Cover Tapa Trasera/Capot Arrière	Cast iron Fundición/Fonte	21	Connection Bolt Perno/Boulon	Steel Acero/Acier
4	O-ring Junta Tórica/Joint Torique	Rubber Caucho/Caoutchouc	13	Reinforced Seal Sello Reforzado/Sceller	Rubber Caucho/Caoutchouc	22	Impeller Nut Nuez/Noix	Galvanized Steel Acero Galvanizado/Acier Galvanisé
5	Connection Conexión/Lien	Cast iron Fundición/Fonte	14	Fan Cover Tapa/Capot	Aluminum Aluminio/Aluminium	23	Release Valve Tapón Cebado/Vanne Purge	Brass Bronce/Laiton
6	Reinforced Seal Sello Reforzado/Sceller	Rubber Caucho/Caoutchouc	15	Fan Ventilador/Ventilateur	Plastic Plástico/Plastique	24	Gasket Empaque/Joint	Rubber Caucho/Caoutchouc
7	Shaft Eje/Arbre	S5304-45# Steel Inox 304-Hierro/Inox304-Acier	16	Through Bolt Perno/Boulon	Steel Acero/Acier	25	Counter Flange Contra Brida/Contre bride	Galvanized Cast iron Fundición Galvanizada/Fonte
8	Bearing Rodamiento/Palier	Ball Bearing Bola Rodamiento/Palier/Balle	17	Terminal Box Caja Bornas/Bolte Bornes	Aluminum Aluminio/Aluminium	26	Flange Bolt Perno Brida/Boulon bride	Steel Acero/Acier
9	Wound Stator/Rotor Estator-Rotor/Stator-Rotor	Silicon Steel/Copper Silicio-Cobre/Silicium-Cuivre	18	Terminal Board Tablero Bornas/Bornier	Plastic Plástico/Plastique			

PERFORMANCE CURVE/CURVA DE RENDIMIENTO/COURBE DE PERFORMANCE

50 Hz n=2900 1/min

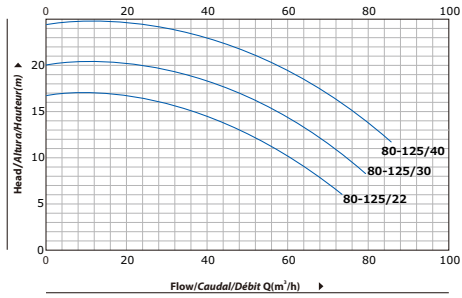

80-125

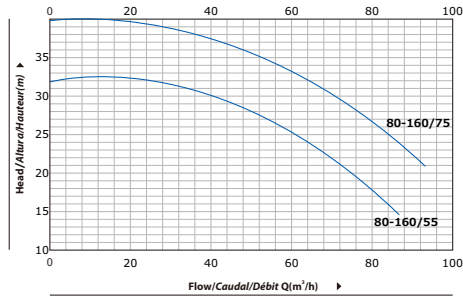

80-160

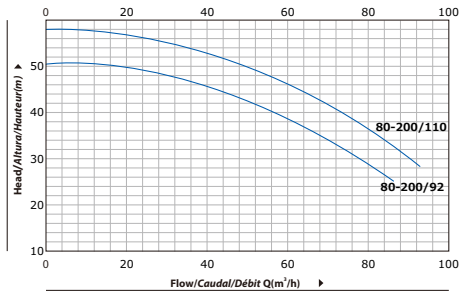

80-200

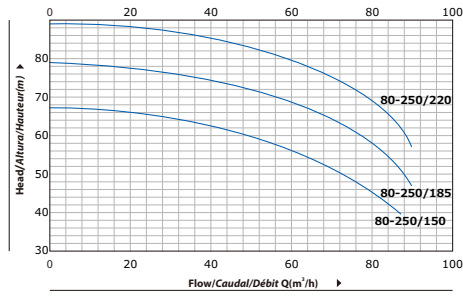

80-250

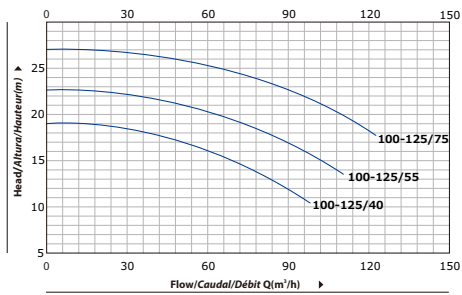

100-125

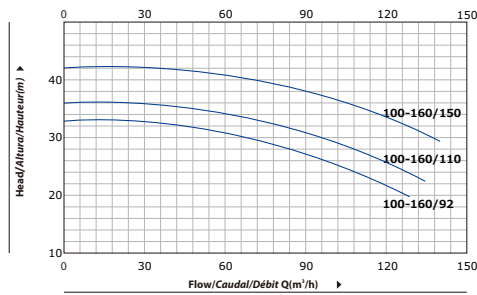

100-160

PERFORMANCE CURVE/CURVA DE RENDIMIENTO/COURBE DE PERFORMANCE

50 Hz n=2900 1/min

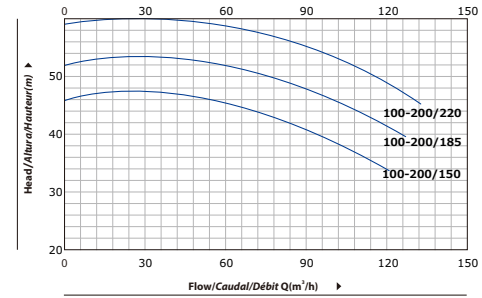

100-200

DIMENSIONS AND WEIGHT/DIMENSIONES Y PESOS/DIMENSIONS ET POIDS

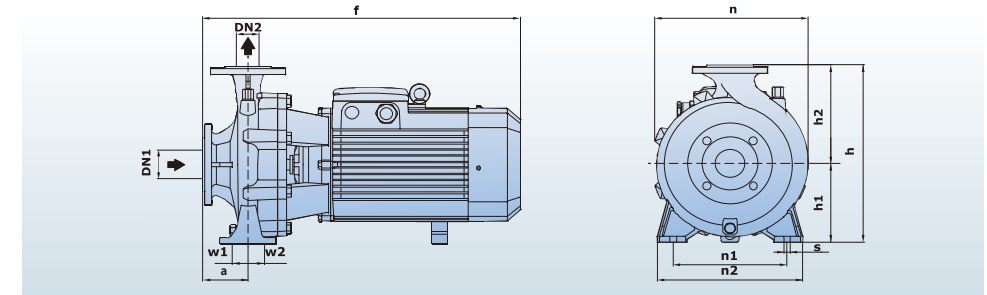

MODEL/MODELO/MODÈLE		DIMENSIONS/DIMENSIONES/DIMENSIONS mm													kg	
Single-phase Monofásico Monophasé	Three-phase Trifásico Triphasé	DN1	DN2	a	f	h	h1	h2	n	n1	n2	w1	w2	s	1~	3~
80-125/22	80-125/22	80	80	102	525	305	135	170	263	190	245	37	37	8	45	41
80-125/30	80-125/30														54	50
-	80-125/40														-	52
-	80-160/55														-	64
-	80-160/75			110	560	345	162	193	270	212	262	-	71			
-	80-200/92											-	90			
-	80-200/110											-	106			
-	80-250/150											-	145			
-	80-250/185			102	720	416	186	230	330	250	327	-	153			
-	80-250/220											-	183			
-	100-125/40											-	56			
-	100-125/55											-	68			
-	100-125/75	104	580	345	162	193	275	212	275	49	49	10	-	74		
-	100-160/92												-	90		
-	100-160/110												-	106		
-	100-160/150												-	134		
-	100-160/150	102	730	415	186	230	330	250	330	-	140					
-	100-200/150									-	140					
-	100-200/185									-	145					
-	100-200/220									-	185					
-	100-200/220	120	740	-	-	-	-	-	-	-	-	-	-	-	-	

PERFORMANCE CURVE/CURVA DE RENDIMIENTO/COURBE DE PERFORMANCE

50 Hz n=2900 1/min

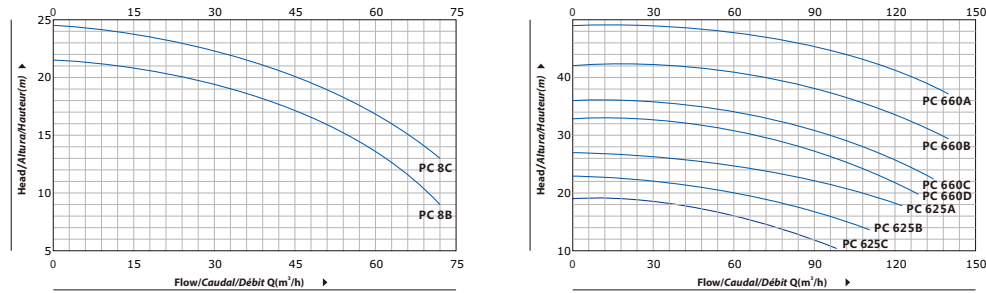

MATERIAL DESCRIPTION/DESCRIPCIÓN DE MATERIAL/DESCRIPTION DU MATÉRIEL

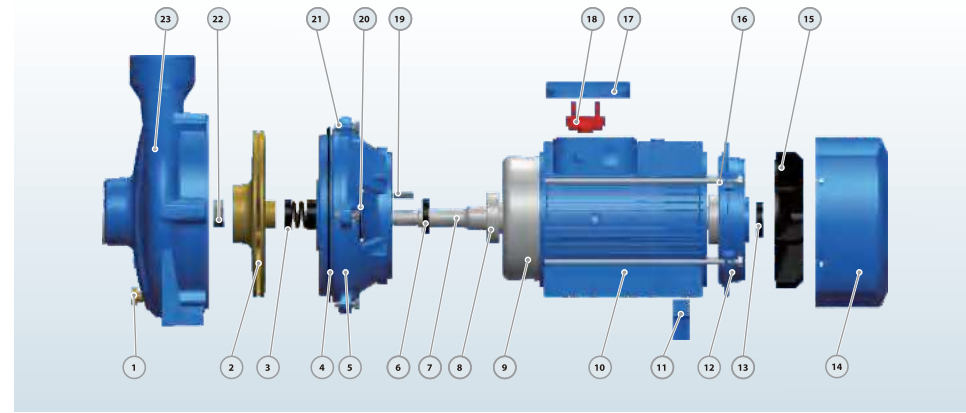

No.	Description Descripción Description	Material Material Matériel	No.	Description Descripción Description	Material Material Matériel	No.	Description Descripción Description	Material Material Matériel
1	Release Valve Tapón Cebado Soupape de décharge	Brass Bronce Laiton	9	Wound Stator/Rotor Estator/Rotor	Silicon Steel/Copper Silicio-Cobre Silicium-Cuivre	17	Terminal Box Caja Bornas Boîte Bornes	Aluminum Aluminio Aluminium
2	Impeller Impulsor Roue	Brass Bronce Laiton	10	Motor Case Cuerpo Motor Boîtier Moteur	Aluminum Aluminio Aluminium	18	Terminal Board Tablero Bornas Bornier	Plastic Plástico Plastique
3	Mechanical Seal Cierre Mecánico Sceller	SiC/Carbon/SS304 SiC/Grafito/Inox304 SiC/Carbon/Inox304	11	Support Foot Soporte Pie Pied support	Plastic Plástico Plastique	19	Impeller Key Chaveta Clé	Iron Hierro Le fer
4	O-ring Junta Toric Joint Torique	Rubber Caucho Caoutchouc	12	Back Cover Tapa Trasera Capot Arrière	Cast Iron Fundición Fonte	20	Water Deflector Deflector Caaoutchouc	Rubber Caucho Caoutchouc
5	Connection Conexión Lien	Cast iron Fundición Fonte	13	Reinforced Seal Sello Reforzado Sceller	Rubber Caucho Caoutchouc	21	Connection Bolt Perno Boulon	Steel Acero Acier
6	Reinforced Seal Sello Reforzado Sceller	Rubber Caucho Caoutchouc	14	Fan Cover Tapa Capot	Aluminum Aluminio Aluminium	22	Impeller Nut Nuez Noix	Galvanized Steel Acero Galvanizado Acier Galvanisé
7	Shaft Eje Arbre	SS304-45# Steel Inox304-Hierro Inox304-Acier	15	Fan Ventilador Ventilateur	Plastic Plástico Plastique	23	Pump Case Cuerpo de Bomba Boîtier de pompe	Cast Iron Fundición Fonte
8	Bearing Rodamiento Palier	Ball Bearing Bola Rodamiento Palier Balle	16	Through Bolt Perno Boulon	Steel Acero Acier			

DIMENSIONS AND WEIGHT/DIMENSIONES Y PESOS/DIMENSIONS ET POIDS

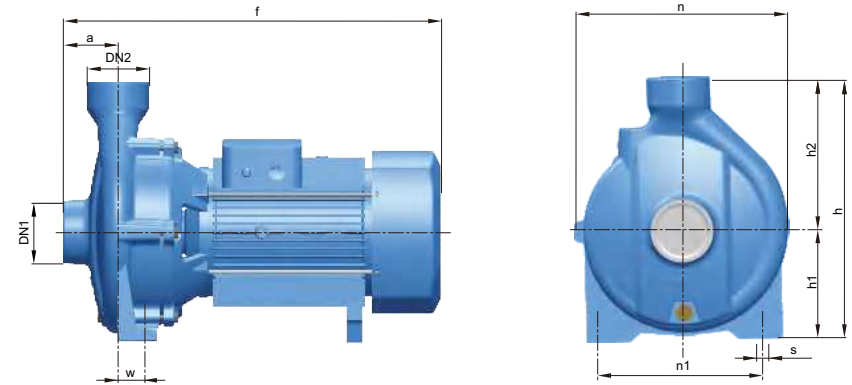

MODEL/MODELO/MODÈLE Single-phase Monofásico Monophasé	Three-phase Trifásico Triphasé	DIMENSIONS/DIMENSIONES/DIMENSIONS mm										kg		
		DN1	DN2	a	f	h	h1	h2	n	n1	w	s	1~	3~
PC 5B	PC 5B	50	50	51	398	265	105	160	206	160	1	11	18	17
PC 5BM	PC 5BM	50	50	51	398	265	105	160	206	160	1	11	19.9	18.9
PC 5AM	PC 5AM	50	50	51	398	265	105	160	206	160	1	11	21.9	20.9
PC 220C	PC 220C	50	50	75	472	322	132	190	245	165	40	14	29.5	28.5
-	PC 220B	50	50	75	472	322	132	190	245	165	40	14	-	32.3
-	PC 680C	50	50	75	535	335	140	195	273	190	40	14	-	42
-	PC 680B	50	50	75	535	335	140	195	273	190	40	14	-	47
PC 6C	PC 6C	80	80	68	435	317	120	197	240	190	6	12	25	24
PC 6B	PC 6B	80	80	68	435	317	120	197	240	190	6	12	26.5	25.5
PC 6A	PC 6A	80	80	68	435	317	120	197	240	190	6	12	27.7	26.7
-	PC 6H	80	80	68	435	317	120	197	240	190	6	12	-	35
-	PC 560C	80	80	79	578	372	163	209	263	212	32	16	-	52
-	PC 560B	80	80	79	578	372	163	209	263	212	32	16	-	64
-	PC 560A	80	80	79	578	372	163	209	263	212	32	16	-	71
PC 8C	PC 8C	100	100	70	482	322	120	202	245	190	30	14	31	30
-	PC 8B	100	100	70	482	322	120	202	245	190	30	14	-	35
-	PC 625C	100	100	85	593	373	163	210	267	212	32	16	-	63
-	PC 625B	100	100	85	593	373	163	210	267	212	32	16	-	68
-	PC 625A	100	100	85	593	373	163	210	267	212	32	16	-	74
-	PC 660D	100	100	85	605	415	186	229	305	222	49	16	-	90
-	PC 660C	100	100	85	605	415	186	229	305	222	49	16	-	106
-	PC 660B	100	100	85	605	415	186	229	305	222	49	16	-	134
-	PC 660A	100	100	85	605	415	186	229	305	222	49	16	-	155

PERFORMANCE CURVE/CURVA DE RENDIMIENTO/COURBE DE PERFORMANCE

50 Hz n=2900 1/min

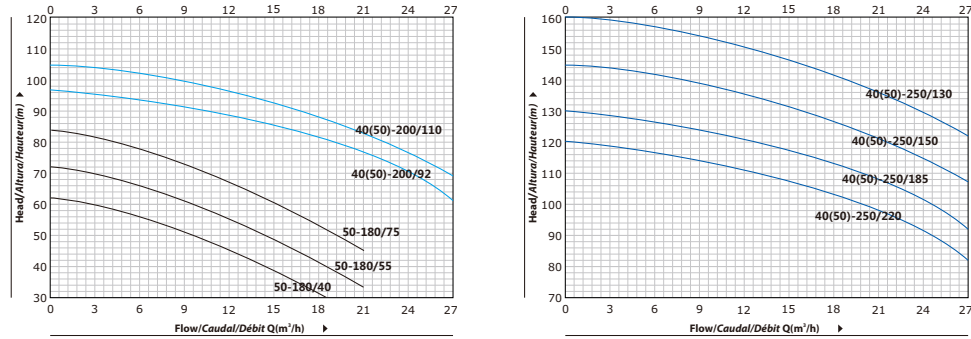

MATERIAL DESCRIPTION/DESCRIPCIÓN DE MATERIAL/DESCRIPTION DU MATÉRIEL

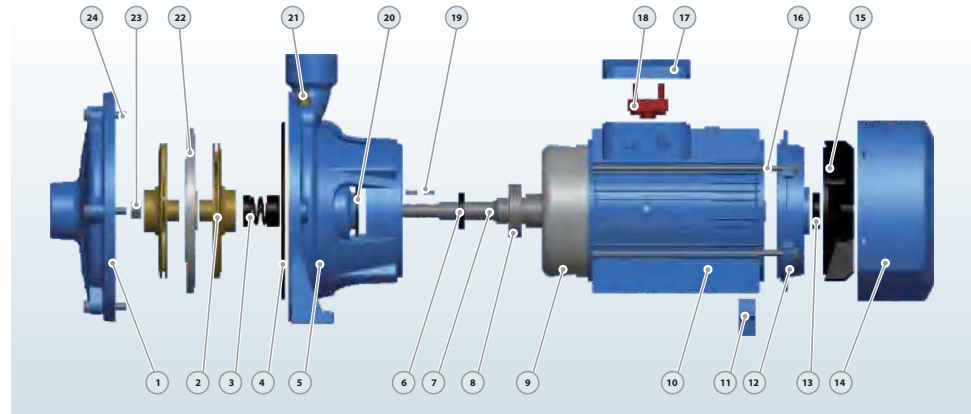

No.	Description Descripción Description	Material Material Matériel	No.	Description Descripción Description	Material Material Matériel	No.	Description Descripción Description	Material Material Matériel
1	Pump Case Cuerpo Boîtier	Cast iron Fundición Fonte	9	Wound Stator/Rotor Estator/Rotor	Silicon Steel/Copper Aluminio Silicium-Cuivre	17	Terminal Box Caja Bornas Boîtie Bornes	Aluminum Aluminio Aluminium
2	Impeller Impulsor Roue	Cast iron Fundición Fonte	10	Motor Case Cuerpo Motor Boîtier Moteur	Aluminum Aluminio Aluminium	18	Terminal Board Tablero Bornas Bornier	Plastic Plástico Plastique
3	Mechanical Seal Cierre Mecánico Sceller	SiC/Carbon/SS304 SiC-Grafito-Inox304 SiC/Carbon/Inox304	11	Support Foot SopORTE Pie Pied support	Plastic Plástico Plastique	19	Impeller Key Chaveta Clé	Iron Hierro Le fer
4	O-ring Junta Toriçca Joint Torique	Rubber Caucho Caoutchouc	12	Back Cover Tapa Trassera Capot Arrière	Cast iron Fundición Fonte	20	Water Deflector Deflector Déflecteur	Rubber Caucho Caoutchouc
5	Connection Conexión Lien	Cast iron Fundición Fonte	13	Reinforced Seal Sello Reforzado Sceller	Rubber Caucho Caoutchouc	21	Release Valve Tapón Cebado Soupape de décharge	Brass Bronce Laiton
6	Reinforced Seal Sello Reforzado Sceller	Rubber Caucho Caoutchouc	14	Fan Cover Tapa Capot	Aluminum Aluminio Aluminium	22	Diffuser Difusor Diffuseur	Cast iron Fundición Fonte
7	Shaft Eje Arbre	SS304-45# Steel Inox304-Hier Inox304-Acier	15	Fan Ventilador Ventilateur	Plastic Plástico Plastique	23	Impeller Nut Nuez Noix	Galvanized Steel Acero Galvanizado Acier Galvanisé
8	Bearing Rodamiento Palier	Ball Bearing Bola Rodamiento Palier/Balle	16	Through Bolt Perno Boulon	Steel Acero Acier	24	Connection Bolt Perno Boulon de connexion	Steel Acero Acier

DIMENSIONS AND WEIGHT/DIMENSIONES Y PESOS/DIMENSIONS ET POIDS

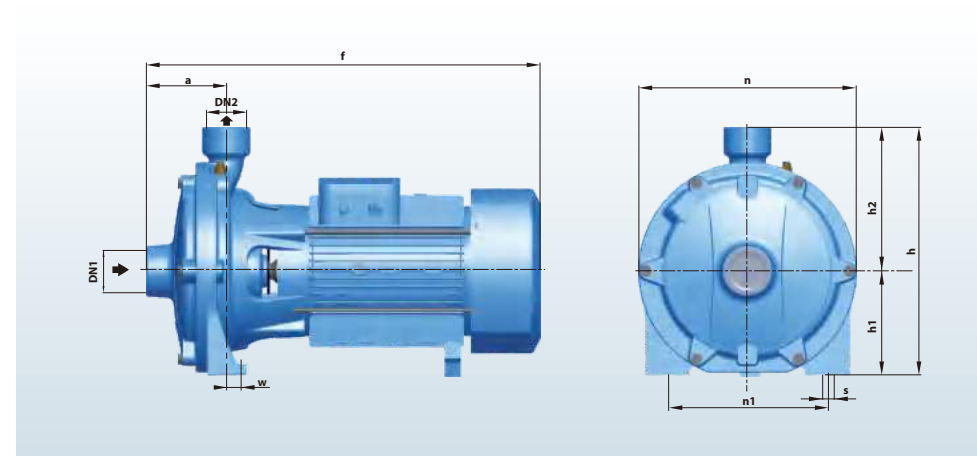

MODEL/MODELO/MODÈLE	THREE-PHASE	DIMENSIONS/DIMENSIONES/DIMENSIONS mm											kg	
Single-phase Monofásico Monophasé	Three-phase Trifásico Triphasé	DN1	DN2	a	f	h	h1	h2	n	n1	w	s	1~	3~
25-140/11	25-140/11	32	25	84	420	232	95	137	200	150	19	10	19.8	18.8
25-140/15	25-140/15	32	25	84	420	232	95	137	200	150	19	10	24	23
25-160/11	25-160/11	32	25	84	420	270	110	160	225	172	19	11	19.8	18.8
25-160/15	25-160/15	32	25	84	420	270	110	160	225	172	19	11	24.2	23.2
25-160/22	25-160/22	32	25	84	420	270	110	160	225	172	19	11	25.5	24.5
32-200/30	32-200/30	40	32	103	503	317	132	185	280	205	16	14	39	38
-	32-200/40	40	32	103	503	317	132	185	280	205	16	14	-	43
-	32-210/55	50	32	108	565	352	155	197	300	246	16	14	-	54
-	32-210/75	50	32	108	565	352	155	197	300	246	16	14	-	61
-	50-180/40-55-75	50	50	108	565	352	155	197	300	246	16	14	-	49/54/61
-	40-210/55-75	50	40	108	565	352	155	197	300	246	16	14	-	54/61
-	40-200/92	50	40	119	615	355	150	205	304	215	11	14	-	89
-	40-200/110	50	40	119	615	355	150	205	304	215	11	14	-	90
-	50-200/92	50	50	119	615	355	150	205	304	215	11	14	-	89
-	50-200/110	50	50	119	615	355	150	205	304	215	11	14	-	90
-	40-250/130	50	40	124	740	407	170	237	357	270	17	14	-	110
-	40-250/150	50	40	124	740	407	170	237	357	270	17	14	-	120
-	40-250/185	50	40	124	740	407	170	237	357	270	17	14	-	130
-	40-250/220	50	40	124	740	407	170	237	357	270	17	14	-	140
-	50-250/130	50	50	124	740	407	170	237	357	270	17	14	-	110
-	50-250/150	50	50	124	740	407	170	237	357	270	17	14	-	120
-	50-250/185	50	50	124	740	407	170	237	357	270	17	14	-	130
-	50-250/220	50	50	124	740	407	170	237	357	270	17	14	-	140

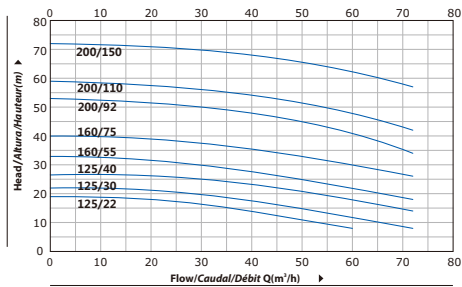

PZ 50

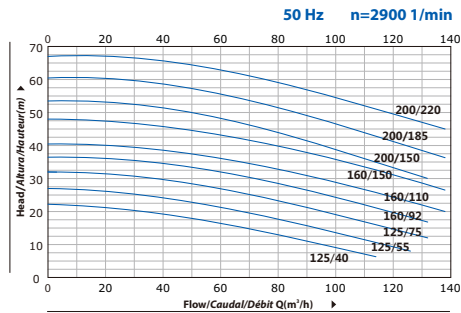

PZ 65

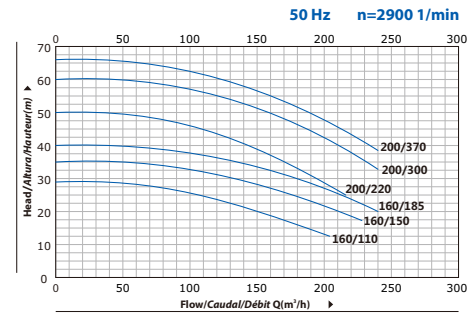

PZ 80

Back pull-out design
Diseño extraíble hacia atrás
Conception arrière coulissante

It allows removal of the motor, the coupling, the cantilever support and the impeller without compromising the housing of the pump body or removing the pipes.

Permite retirar el motor, el acoplamiento, el soporte en voladizo y el impulsor sin comprometer la carcasa del cuerpo de la bomba ni quitar las tuberías.

Il permet le démontage du moteur, de l'accouplement, du support en porte-à-faux et de la roue sans compromettre le logement du corps de pompe ou retirer les tuyaux.

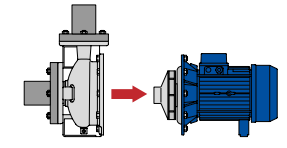

MATERIAL DESCRIPTION/DESCRIPCIÓN DE MATERIAL/DESCRIPTION DU MATÉRIEL

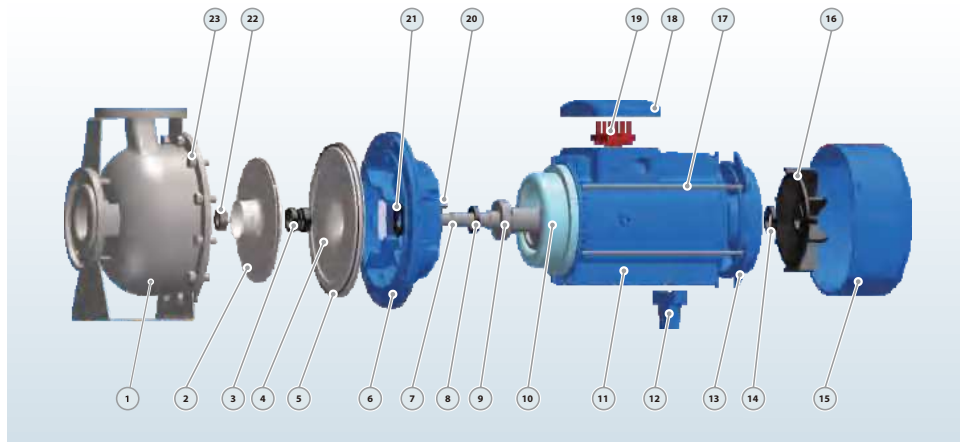

No.	Description Descripción Description	Material Material Matériel	No.	Description Descripción Description	Material Material Matériel	No.	Description Descripción Description	Material Material Matériel
1	Pump Case Cuerpo de Bomba Boîtier de pompe	SS304 Inox 304 Inox 304	9	Bearing Rodamiento Palier	Ball Bearing Bola Rodamiento Palier Balle	17	Through Bolt Perno Boulon	Steel Acero Acier
2	Impeller Impulsor Roue	SS304 Inox 304 Inox 304	10	Wound Stator/Rotor Estator/Rotor Stator/Rotor	Silicon/Copper Silicio/Cobre Silicium/Cuivre	18	Terminal Box Caja Bornas Boîte Bornes	Aluminum Aluminio Aluminium
3	Mechanical Seal Cierre Mecánico Sceller	SiC/Carbon/SS304 SiC/Grafito/Inox304 SiC/Carbon/Inox304	11	Motor Case Cuerpo Motor Boîtier Moteur	Aluminum Aluminio Aluminium	19	Terminal Board Tablero Bornas Bornier	Plastic Plástico Plastique
4	Baffle plate Placa de baffle Plaque chicane	SS304 Inox 304 Inox 304	12	Support Foot Soporte Pie Pied support	Plastic Plástico Plastique	20	Impeller Key Chaveta Clé	Iron Hierro Le fer
5	O-ring Junta Tórica Joint Torique	Rubber Caucho Caoutchouc	13	Back Cover Tapa Trasera Capot Arrière	Cast iron Fundición Fonte	21	Water Deflector Deflector Déflecteur	Rubber Caucho Caoutchouc
6	Connection Conexión Lien	Cast iron Fundición Fonte	14	Reinforced Seal Sello Reforzado Sceller	Rubber Caucho Caoutchouc	22	Impeller Nut Nuez Noix	Galvanized Steel Acero Galvanizado Acier Galvanisé
7	Shaft Eje Arbre	SS304 Inox 304 Inox 304	15	Fan Cover Tapa Capot Capot	Aluminum Aluminio Aluminium	23	Connection Bolt Perno Boulon de connexion	Steel Acero Acier
8	Reinforced Seal Sello Reforzado Sceller	Rubber Caucho Caoutchouc	16	Fan Ventilador Ventilateur	Plastic Plástico Plastique			

DIMENSIONS AND WEIGHT/DIMENSIONES Y PESOS/DIMENSIONS ET POIDS

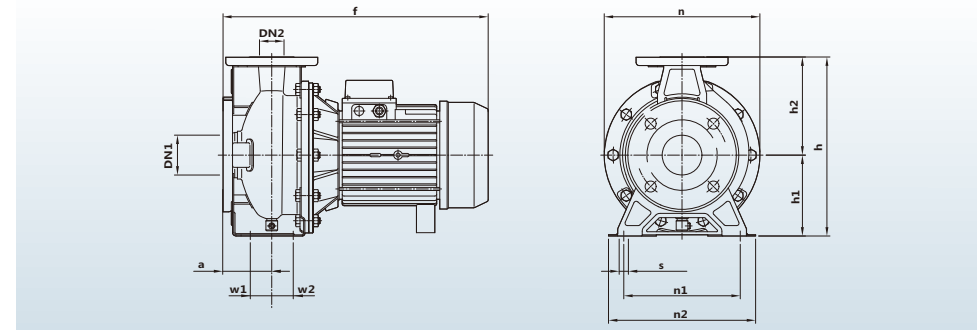

MODEL/ MODELO/ MODÈLE		DIMENSIONS/DIMENSIONES/DIMENSIONS mm													kg	
Single-phase Monofásico Monophasé	Three-phase Trifásico Triphasé	DN1	DN2	a	f	h	h1	h2	n	n1	n2	w1	w2	s	1~	3~
32-160/11-15	32-160/11-15	50	32	100	493	306	150	156	235	148	175	60	31	15	20.6/23.5	19.6/22.5
32-160/22	32-160/22	50	32	100	493	306	150	156	235	148	175	60	31	15	25.6	24.6
32-200/30	32-200/30-40	50	32	100	538	306	150	156	235	148	175	60	31	15	33.8	32.8/39.5
-	32-200/55	50	32	100	538	306	150	156	235	148	175	60	31	15	-	48.5
40-125/15-22	40-125/15-22	65	40	100	493	306	150	156	235	148	175	60	31	15	21.1/23.7	20.1/22.7
40-160/30	40-160/30-40	65	40	105	542	340	160	180	278	148	175	60	31	15	29	28/35.1
-	40-200/55-75	65	40	105	584	340	160	180	278	148	175	60	31	15	-	48.8/56.2
-	40-200/110	65	40	105	650	340	160	180	235	148	175	60	31	15	-	67.5
50-125/22	50-125/22	65	50	100	428	340	160	180	235	148	175	60	31	15	29.1	28.1
50-125/30	50-125/30-40	65	50	100	493	340	160	180	278	148	175	60	31	15	29.6	28.6/35.2
-	50-160/55-75	65	50	105	584	340	160	180	278	148	175	60	31	15	-	49.1/55.5
-	50-200/92-110	65	50	105	650	365	185	180	278	148	175	60	31	15	-	61.7/67.5
-	50-200/150	65	50	105	768	365	185	180	278	148	175	60	31	15	-	96
-	65-125/40	80	65	100	584	340	160	180	278	148	175	60	31	15	-	40
-	65-125/55-75	80	65	100	584	340	160	180	278	148	175	60	31	15	-	52/58.5
-	65-160/92-110	80	65	113	675	345	160	185	278	148	175	60	31	15	-	67/75.6
-	65-160/150	80	65	113	732	345	160	185	278	148	175	60	31	15	-	93
-	65-200/150-185	80	65	113	793	370	185	185	278	148	175	60	31	15	-	114/127
-	65-200/220	80	65	113	793	370	185	185	278	148	175	60	31	15	-	136
-	80-160/110	100	80	125	700	400	180	220	278	148	175	60	31	15	-	85
-	80-160/150-185	100	80	125	870	400	180	220	278	148	175	60	31	15	-	119/135
-	80-200/220	100	80	125	915	450	200	250	278	148	175	60	31	15	-	185
-	80-200/300-370	100	80	125	985	450	200	250	278	148	175	60	31	15	-	265/285

PERFORMANCE CURVE/CURVA DE RENDIMIENTO/COURBE DE PERFORMANCE

50 Hz n=2900 1/min

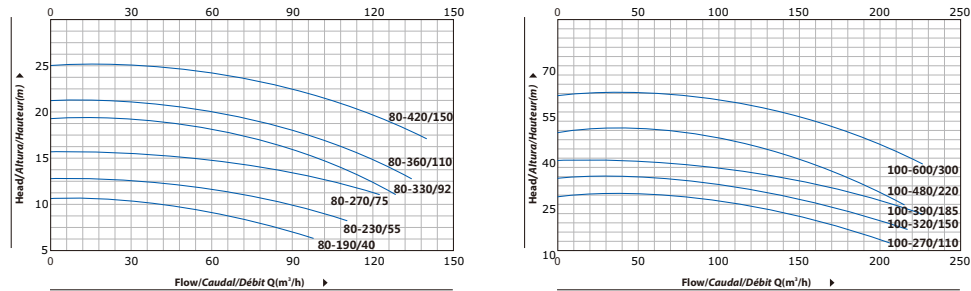

MATERIAL DESCRIPTION/DESCRIPCIÓN DE MATERIAL/DESCRIPTION DU MATÉRIEL

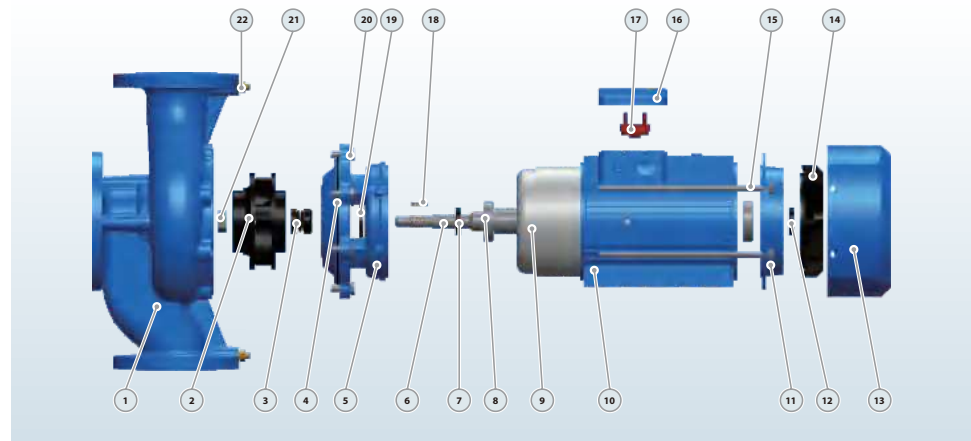

No.	Description Descripción Description	Material Material Matériel	No.	Description Descripción Description	Material Material Matériel	No.	Description Descripción Description	Material Material Matériel
1	Pump Case Cuerpo de Bomba Boîtier de pompe	Cast iron Fundición Fonte	9	Wound Stator/Rotor Estator/Rotor Stator/Rotor	Silicon Steel/Copper Silicio/Cobre Silicium/Cuivre	17	Terminal Board Tablero Bornas Bornier	Plastic Plástico Plastique
2	Impeller Impulsor Roue	SS304/Cast iron Inox 304/Fundición Inox 304/Fonte	10	Motor Case Cuerpo Motor Boîtier Moteur	Aluminum Aluminio Aluminium	18	Impeller Key Chaveta Clé	Iron Hierro Le fer
3	Mechanical Seal Cierre Mecánico Sceller	SiC/Carbon/SS304 SiC/Grafito/Inox304 SiC/Carbon/Inox304	11	Back Cover Tapa Trasera Capot Amière	Cast iron Fundición Fonte	19	Water Deflector Deflector Déflecteur	Rubber Caucho Caoutchouc
4	O-ring Junta Tórica Joint Torique	Rubber Caucho Caoutchouc	12	Reinforced Seal Sello Reforzado Sceller	Rubber Caucho Caoutchouc	20	Connection Bolt Perno Boulon de connexion	Steel Acero Acier
5	Connection Conexión Lien	Cast iron Fundición Fonte	13	Fan Cover Tapa Capot Capot	Aluminum Aluminio Aluminium	21	Impeller Nut Nuez Noix	Galvanized Steel Acero Galvanizado Acier Galvanisé
6	Shaft Eje Arbre	SS304-45# Steel Inox 304-Hierro Inox304-Acier	14	Fan Ventilador Ventilateur	Plastic Plástico Plastique	22	Release Valve Tapón Cebado Soupape de décharge	Brass Bronce Laiton
7	Reinforced Seal Sello Reforzado Sceller	Rubber Caucho Caoutchouc	15	Through Bolt Perno Boulon	Steel Acero Acier			
8	Bearing Rodamiento Palier	Ball Bearing Bola Rodamiento Palier Balle	16	Terminal Box Caja Bornas Boîte Bornes	Aluminum Aluminio Aluminium			

DIMENSIONS AND WEIGHT/DIMENSIONES Y PESOS/DIMENSIONS ET POIDS

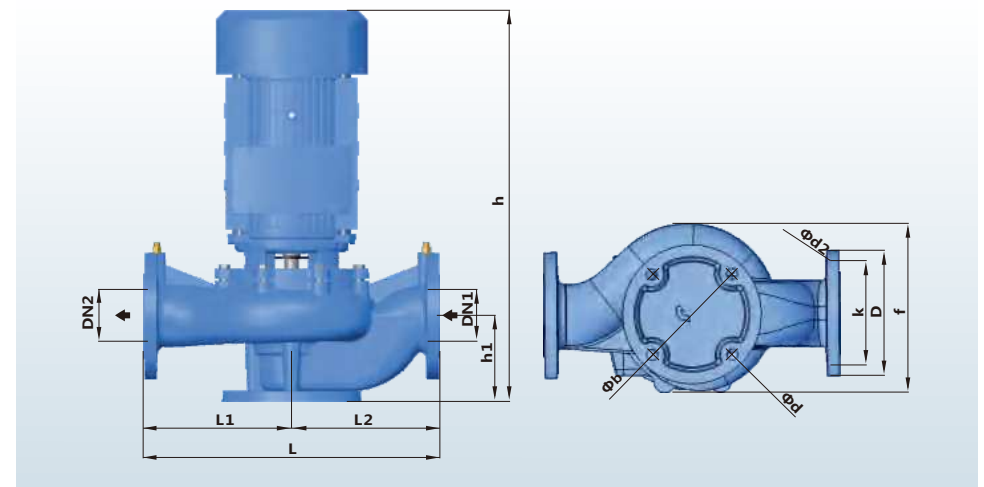

MODEL MODELO MODÈLE	DIMENSIONS/DIMENSIONES/DIMENSIONS mm												kg		
	DN1	DN2	h	h1	L	b	f	d	L1	L2	D	K	d2	1~	3~
50-170/7	50	50	475	115	340	145	197	18	170	170	165	125	4*18	26	24
50-220/11	50	50	475	115	340	145	197	18	170	170	165	125	4*18	27	25
50-250/15	50	50	450	100	322	145	229	18	161	161	165	125	4*18	36	34
50-310/22	50	50	450	100	322	145	229	18	161	161	165	125	4*18	41	39
50-350/30	50	50	480	100	322	145	229	18	161	161	165	125	4*18	52	50
50-410/40	50	50	485	115	440	160	277	18	220	220	165	125	4*18	-	59
50-460/55	50	50	485	115	440	160	277	18	220	220	165	125	4*18	-	66
50-570/75	50	50	485	115	440	160	277	18	220	220	165	125	4*18	-	73
65-140/11	65	65	465	105	360	145	212	18	180	180	185	145	4*18	29	27
65-180/15	65	65	465	105	360	145	212	18	180	180	185	145	4*18	31	29
65-240/22	65	65	465	105	360	145	212	18	180	180	185	145	4*18	36	34
65-310/30	65	65	530	112	400	160	250	18	200	200	185	145	4*18	50	48
65-380/40	65	65	530	112	400	160	250	18	200	200	185	145	4*18	-	50
65-320/55	65	65	583	112	400	160	263	18	200	200	185	145	4*18	-	64
65-400/75	65	65	583	112	400	160	263	18	200	200	185	145	4*18	-	71
80-190/40	80	80	615	135	470	180	267	18	235	235	200	160	8*18	-	56
80-230/55	80	80	615	135	470	180	267	18	235	235	200	160	8*18	-	68
80-270/75	80	80	615	135	470	180	267	18	235	235	200	160	8*18	-	74
80-330/92	80	80	658	135	470	200	290	18	235	235	200	160	8*18	-	90
80-360/110	80	80	658	135	470	200	290	18	235	235	200	160	8*18	-	106
80-420/150	80	80	780	135	470	200	290	18	235	235	200	160	8*18	-	134
100-270/110	100	100	685	160	552	220	310	18	276	276	220	180	8*18	-	113
100-320/150	100	100	807	160	552	220	310	18	276	276	220	180	8*18	-	143
100-390/185	100	100	807	160	552	220	310	18	276	276	220	180	8*18	-	150
100-480/220	100	100	880	160	552	220	322	18	276	276	220	180	8*18	-	212
100-600/300	100	100	950	160	552	220	322	18	276	276	220	180	8*18	-	222



PGL

PGW



PGLH



PGWH



PGWB

PG

Single suction centrifugal pump
Bomba centrífuga de succión simple
Pompe centrifuge à aspiration unique



NEW/NEUVO/NOUVEAU

DESCRIPTION/DESCRIPCIONES/DESCRIPTION

- ◆ Complete range with a full series of centrifugal pump
 - ◆ Vertical and horizontal design suitable for any installation
 - ◆ Stainless steel 304 casting material available for all models
 - ◆ Available equipped with explosion-proof motors
 - ◆ The big range pumps compatible with many applications
 - ◆ Pump case with anti-corrosive coating
 - ◆ Quality bearing, wear resistance mechanical seal
- ◆ Gama completa con una serie completa de bombas
 - ◆ Diseño vertical y horizontal adecuado para cualquier instalación
 - ◆ Material de fundición de inox304 disponible para todos los modelos
 - ◆ Disponible con motores a prueba de explosión
 - ◆ La impresionante gama compatibles con muchas aplicaciones
 - ◆ Caja de bomba con revestimiento anticorrosivo
 - ◆ Rodamiento de calidad, sello mecánico personalizado
- ◆ Gamme complète avec une série complète de pompes
 - ◆ Conception verticale et horizontale adaptée à toute installation
 - ◆ Matériau de coulée en inox304 disponible pour tous les modèles
 - ◆ Disponible équipé de moteurs antidéflagrants
 - ◆ La gamme impressionnante compatibles avec de nombreuses applications
 - ◆ Boîtier de pompe avec revêtement anti-corrosif
 - ◆ Roulement de qualité, joint mécanique résistant à l'usage

MODEL CODE/CÓDIGO MODELO/CODE MODÈLE

For example/ Por ejemplo/ Par exemple

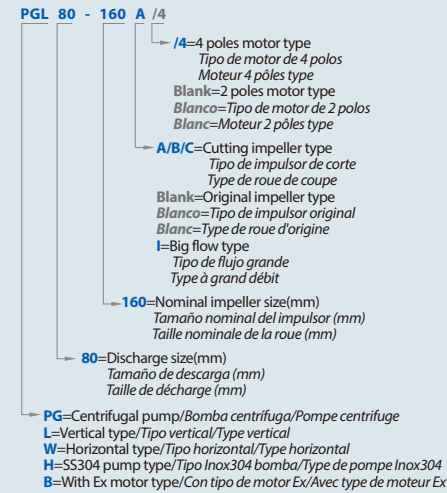

TECHNICAL DATA/DATOS TÉCNICOS/DONNÉES TECHNIQUES

MODEL MODELO MODÈLE	Power Potencia Puissance		Flow Caudal Débit	Head Altura Hauteur	DN	Wt	Dim
	kw	hp					
25-125	0.75	1	4	20	25x25	28	26x23x43
25-125A	0.75	1	3.6	16	25x25	27	26x23x43
25-160	1.5	2	4	32	25x25	39	30x27x43
25-160A	1.1	1.5	3.7	28	25x25	34	30x27x43
32-125	0.75	1	5	20	32x32	28	26x23x44
32-125A	0.75	1	4.5	16	32x32	28	26x23x44
32-160	1.5	2	4.5	32	32x32	39	32x27x50
32-160A	1.1	1.5	4	28	32x32	38	32x27x41
32-200	3	4	4.5	50	32x32	55	34x33x54
32-200A	2.2	3	4	44	32x32	74	34x33x54
40-100	0.75	1	6.3	12.5	40x40	47	26x23x44
40-125	1.1	1.5	6.3	20	40x40	34	26x23x44
40-125A	0.75	1	5.6	16	40x40	33	28x23x44
40-160	2.2	3	6.3	32	40x40	47	32x27x50
40-160A	1.5	2	5.9	28	40x40	43	32x27x50
40-160B	1.1	1.5	5.5	24	40x40	38	32x27x50
40-200	4	5.5	6.3	50	40x40	74	34x33x56
40-200A	3	4	5.9	44	40x40	62	34x33x56
40-200B	2.2	3	3.7	38	40x40	52	34x33x56
40-250	7.5	10	6.3	80	40x40	105	40x40x63
40-250A	5.5	7.5	5.9	70	40x40	98	40x40x63
40-250B	4	5.5	5.5	60	40x40	77	40x40x63
40-100(I)	1.1	1.5	12.5	12.5	40x40	34	30x23x45
40-100(I)A	0.75	1	11	10	40x40	32	30x23x45
40-125(I)	1.5	2	12.5	20	40x40	38	30x24x46
40-125(I)A	1.1	1.5	11	16	40x40	33	30x24x45
40-160(I)	3	4	12.5	32	40x40	56	34x30x55
40-160(I)A	2.2	3	11.7	28	40x40	47	34x30x51
40-200(I)	5.5	7.5	12.5	50	40x40	85	36x35x63
40-200(I)A	4	5.5	11.7	44	40x40	75	36x35x57
40-200(I)B	3	4	10.6	36	40x40	63	36x35x55
40-250(I)	11	15	12.5	80	40x40	145	45x43x78
40-250(I)A	7.5	10	11.6	70	40x40	95	45x36x65
40-250(I)B	7.5	10	10.8	60	40x40	94	45x36x65
50-100	1.1	1.5	12.5	12.5	50x50	36	29x23x45
50-100A	0.75	1	11	10	50x50	35	29x23x45
50-125	1.5	2	12.5	20	50x50	43	30x24x46
50-125A	1.1	1.5	11	16	50x50	38	30x24x45
50-160	3	4	12.5	32	50x50	59	32x30x55
50-160A	2.2	3	11.7	28	50x50	51	32x30x51
50-160B	1.5	2	10.4	22	50x50	47	32x40x49
50-200	5.5	7.5	12.5	50	50x50	101	36x35x63
50-200A	4	5.5	11.7	44	50x50	80	36x35x57
50-200B	3	4	10.6	36	50x50	68	36x35x55
50-250	11	15	12.5	80	50x50	160	44x43x78
50-250A	7.5	10	11.6	70	50x50	115	44x43x65
50-250B	7.5	10	10.8	60	50x50	114	44x36x65
50-100(I)	1.5	2	25	12.5	50x50	41	32x23x48
50-100(I)A	1.1	1.5	22.3	10	50x50	36	32x23x46
50-125(I)	3	4	25	20	50x50	56	34x28x55
50-125(I)A	2.2	3	22.3	16	50x50	48	34x28x52

50 Hz n=2900 1/min

MODEL MODELO MODÈLE	Power Potencia Puissance		Flow Caudal Débit	Head Altura Hauteur	DN	Wt	Dim
	kw	hp					
50-160(I)	4	5.5	25	32	50x50	72	36x30x57
50-160(I)A	4	5.5	23.4	28	50x50	71	36x30x57
50-160(I)B	3	4	21.6	24	50x50	59	36x30x55
50-200(I)	7.5	10	25	50	50x50	108	38x35x64
50-200(I)A	7.5	10	23.5	44	50x50	107	38x35x64
50-200(I)B	5.5	7.5	21.8	38	50x50	100	38x35x64
50-250(I)	1.5	2	25	80	50x50	175	46x44x79
50-250(I)A	11	15	23.4	70	50x50	165	46x44x79
50-250(I)B	11	15	21.6	60	50x50	165	46x44x79
50-315(I)	30	40	25	125	50x50	310	55x51x92
50-315(I)A	22	30	23.7	113	50x50	245	55x47x86
50-315(I)B	18.5	25	22.5	101	50x50	215	55x44x83
65-100	1.5	2	25	12.5	65x65	46	32x23x47
65-100A	1.1	1.5	22.3	10	65x65	41	32x23x46
65-125	3	4	25	20	65x65	58	34x28x55
65-125A	2.2	3	22.3	16	65x65	49	34x28x52
65-160	4	5.5	25	32	65x65	75	36x31x57
65-160A	4	5.5	23.4	28	65x65	75	36x31x57
65-160B	3	4	21.6	24	65x65	63	36x31x55
65-200	7.5	10	25	50	65x65	107	38x35x63
65-200A	7.5	10	23.5	44	65x65	107	38x35x63
65-200B	5.5	7.5	21.8	38	65x65	100	38x35x63
65-250	15	20	25	80	65x65	180	48x44x79
65-250A	11	15	23.4	70	65x65	170	48x44x79
65-250B	11	15	21.6	60	65x65	170	48x44x79
65-315	30	40	25	125	65x65	320	55x51x92
65-315A	22	30	23.7	113	65x65	255	55x47x86
65-315B	18.5	25	22.5	101	65x65	225	55x44x83
65-100(I)	3	4	50	125	65x65	63	40x28x57
65-100(I)A	2.2	3	44.7	10	65x65	53	40x24x54
65-125(I)	5.5	7.5	50	20	65x65	99	40x36x66
65-125(I)A	4	5.5	45	16	65x65	78	40x32x60
65-160(I)	7.5	10	50	32	65x65	103	40x36x66
65-160(I)A	7.5	10	46.7	28	65x65	103	40x36x66
65-160(I)B	5.5	7.5	43.4	24	65x65	97	40x32x66
65-200(I)	15	20	50	50	65x65	176	45x43x80
65-200(I)A	11	15	47	44	65x65	166	45x43x80
65-200(I)B	7.5	10	43.3	38	65x65	114	45x43x67
65-250(I)	22	30	50	80	65x65	235	48x47x87
65-250(I)A	18.5	25	46.7	70	65x65	205	48x43x85
65-250(I)B	15	20	43.3	60	65x65	180	48x43x81
65-315(I)	37	50	50	125	65x65	350	58x53x100
65-315(I)A	30	40	46.5	110	65x65	335	58x53x100
80-100	3	4	50	125	80x80	63	40x28x57
80-100A	2.2	3	44.7	10	80x80	54	40x24x54
80-125	5.5	7.5	50	20	80x80	99	40x36x66
80-125A	4	5.5	45	16	80x80	79	40x32x60
80-160	7.5	10	50	32	80x80	105	40x36x66
80-160A	7.5	10	46.7	28	80x80	105	40x36x66
80-160B	5.5	7.5	43.4	24	80x80	98	40x36x66
80-200	15	20	50	50	80x80	175	43x43x80

TECHNICAL DATA/DATOS TÉCNICOS/DONNÉES TECHNIQUES

50 Hz n=2900 1/min

MODEL MODELO MODELE	Power Potencia Puissance		Flow Caudal Débit	Head Altura Hauteur	DN	Wt	Dim
	kw	hp					
	m ³ /h	m					
80-200A	11	15	47	44	80x80	165	43x43x80
80-200B	7.5	10	43.3	38	80x80	115	43x36x66
80-250	22	30	50	80	80x80	240	48x47x87
80-250A	18.5	25	46.7	70	80x80	210	48x43x85
80-250B	15	20	43.3	60	80x80	185	48x43x81
80-315	37	50	50	125	80x80	355	58x53x100
80-315A	30	40	46.5	110	80x80	340	58x53x100
80-315B	30	40	44.5	100	80x80	340	58x53x100
80-315C	22	30	41	85	80x80	275	58x47x89
80-350	55	75	50	150	80x80	535	64x64x117
80-350A	45	60	44.5	142	80x80	420	64x58x108
80-350B	37	50	41	135	80x80	366	64x52x104
80-100(I)	5.5	7.5	100	12.5	80x80	108	46x36x68
80-100(I)A	4	5.5	89	10	80x80	87	46x36x62
80-125(I)	11	15	100	20	80x80	163	45x43x81
80-125(I)A	7.5	10	89	16	80x80	113	45x35x67
80-160(I)	15	20	100	32	80x80	184	50x43x84
80-160(I)A	11	15	93.5	28	80x80	174	50x43x84
80-160(I)B	11	15	86.6	24	80x80	174	50x43x84
80-200(I)	22	30	100	50	80x80	251	48x48x88
80-200(I)A	18.5	25	93.5	44	80x80	220	48x43x86
80-200(I)B	15	20	87	38	80x80	198	48x43x81
80-250(I)	37	50	100	80	80x80	330	55x52x102
80-250(I)A	30	40	93.5	70	80x80	315	55x52x102
80-250(I)B	30	40	87	60	80x80	315	55x52x102
80-315(I)	75	100	100	125	80x80	675	64x70x124
80-315(I)A	55	75	95	113	80x80	535	64x64x117
80-315(I)B	45	60	90	101	80x80	420	64x58x108
80-315(I)C	37	50	82	85	80x80	366	64x52x104
100-100	5.5	7.5	100	12.5	100x100	113	46x36x67
100-100A	4	5.5	89	10	100x100	91	46x32x62
100-125	11	15	100	20	100x100	169	44x43x81
100-125A	7.5	10	89	16	100x100	118	45x35x67
100-160	15	20	100	32	100x100	191	50x43x84
100-160A	11	15	93.5	28	100x100	181	50x43x84
100-160B	11	15	86.6	24	100x100	181	50x43x84
100-200	22	30	100	50	100x100	245	48x48x88
100-200A	18.5	25	93.5	44	100x100	215	48x43x86
100-200B	15	20	87	38	100x100	193	48x43x82
100-250	37	50	100	80	100x100	345	55x52x102
100-250A	30	40	93.5	70	100x100	330	55x52x102
100-250B	30	40	87	60	100x100	330	55x52x102
100-315	75	100	100	125	100x100	689	64x70x124
100-315A	55	75	95	113	100x100	549	64x64x117
100-315B	45	60	90	101	100x100	439	64x58x108
100-350	90	120	100	150	100x100	950	68x63x131
100-350A	75	100	88	142	100x100	830	68x63x126
100-350B	55	75	80	135	100x100	600	68x61x119
100-100(I)	11	15	160	12.5	100x100	115	50x42x80
100-125(I)	15	20	160	20	100x100	168	50x30x81
100-125(I)A	11	15	140	17	100x100	168	50x28x81

MODEL MODELO MODELE	Power Potencia Puissance		Flow Caudal Débit	Head Altura Hauteur	DN	Wt	Dim
	kw	hp					
	m ³ /h	m					
100-160(I)	22	30	160	32	100x100	210	50x33x89
100-160(I)A	18.5	25	140	28	100x100	210	50x33x89
100-200(I)	37	50	160	50	100x100	402	54x36x97
100-200(I)A	30	40	140	45	100x100	395	54x35x97
100-200(I)B	22	30	100	40	100x100	360	54x35x97
100-250(I)	55	75	160	80	100x100	560	60x44x112
100-250(I)A	45	60	140	72	100x100	420	60x36x112
100-250(I)B	37	50	100	65	100x100	400	60x36x112
125-100	11	15	160	12.5	125x125	180	52x43x83
125-100A	7.5	10	143	10	125x125	125	52x36x83
125-125	15	20	160	20	125x125	220	52x43x84
125-125A	11	15	143	16	125x125	210	52x43x84
125-160	22	30	160	32	125x125	265	52x46x92
125-160A	18.5	25	150	28	125x125	230	52x43x89
125-160B	15	20	138	24	125x125	215	52x43x85
125-200	37	50	160	50	125x125	395	57x51x104
125-200A	30	40	150	44	125x125	380	57x51x104
125-200B	22	30	138	37.5	125x125	320	57x46x108
125-250	55	75	160	80	125x125	580	68x66x118
125-250A	45	60	150	70	125x125	490	68x57x108
125-250B	37	50	138	60	125x125	430	68x51x105
125-315	90	120	160	125	125x125	790	68x69x130
125-315A	75	100	150	110	125x125	710	68x69x135
125-315B	75	100	143	100	125x125	705	68x69x135
125-315C	55	75	134	88	125x125	585	68x66x123
125-350	110	150	160	150	125x125	980	76x90x156
125-350A	90	120	150	142	125x125	800	76x70x133
125-350B	75	100	143	135	125x125	724	76x70x121
150-125	11	15	160	20	150x150	130	52x43x84
150-125A	7.5	10	150	16	150x150	110	52x43x84
150-160	22	30	160	32	150x150	270	52x43x85
150-160A	18.5	25	150	28	150x150	230	52x43x85
150-160B	15	20	140	24	150x150	220	52x43x85
150-200	37	50	160	50	150x150	395	57x51x104
150-200A	30	40	150	44	150x150	380	57x51x104
150-200B	22	30	138	37.5	150x150	320	57x46x108
150-250	75	100	160	80	150x150	702	70x70x128
150-250A	55	75	150	70	150x150	561	70x64x120
150-250B	45	60	138	60	150x150	460	70x59x112
150-315	110	150	200	125	150x150	980	76x90x156
150-315A	90	120	187	110	150x150	800	76x70x133
150-315B	75	100	173	95	150x150	724	76x70x121
150-350	110	150	160	150	150x150	980	76x90x156
150-350A	90	120	150	142	150x150	800	76x70x133
150-350B	75	100	140	135	150x150	724	76x70x121
150-250(I)	75	100	200	80	150x150	702	70x70x128
150-250(I)A	55	75	187	70	150x150	561	70x64x120
150-250(I)B	45	60	173	60	150x150	460	70x59x112
150-315(I)	110	150	200	125	150x150	980	76x90x156
150-315(I)A	90	120	187	110	150x150	800	76x70x133
150-315(I)B	75	100	173	95	150x150	724	76x70x121

TECHNICAL DATA/DATOS TÉCNICOS/DONNÉES TECHNIQUES

50 Hz n=1450 1/min

MODEL MODELO MODELE	Power Potencia Puissance		Flow Caudal Débit	Head Altura Hauteur	DN	Wt	Dim
	kw	hp					
	m ³ /h	m					
40-125(I)/4	0.55	0.75	6.3	5	40x40	42	34x30x55
40-160(I)/4	0.55	0.75	6.3	8	40x40	43	34x30x55
40-160(I)A/4	0.55	0.75	5.5	6	40x40	30	34x30x55
40-200(I)/4	0.75	1	6.3	12.5	40x40	45	36x35x64
40-200(I)A/4	0.55	0.75	5.8	11	40x40	44	36x35x57
40-250(I)/4	1.5	2	6.3	20	40x40	54	45x43x78
40-250(I)A/4	1.1	1.5	5.8	17	40x40	49	45x36x65
50-160(A)	0.75	1	6.3	8	50x50	42	32x30x55
50-200(A)	0.75	1	6.3	12.5	50x50	48	36x35x64
50-200(A/4)	0.75	1	5.5	9.5	50x50	46	36x35x57
50-250(A/4)	1.5	2	6.3	20	50x50	58	44x43x78
50-250(A)	1.1	1.5	5.8	17	50x50	50	44x36x65
50-125(I)/4	0.55	0.75	12.5	5	50x50	44	34x28x55
50-160(I)/4	0.55	0.75	12.5	8	50x50	46	36x31x57
50-160(I)A/4	0.55	0.75	11	6	50x50	44	36x31x57
50-200(I)/4	1.1	1.5	12.5	12.5	50x50	52	38x35x64
50-200(I)A/4	0.75	1	11.2	10	50x50	48	38x35x64
50-250(I)/4	2.2	3	12.5	20	50x50	73	46x44x79
50-250(I)A/4	1.5	2	11.7	17.5	50x50	65	46x44x79
50-250(I)B/4	1.1	1.5	10	13	50x50	60	46x44x79
50-315(I)/4	4	5.5	12.5	32	50x50	89	55x51x92
50-315(I)A/4	3	4	11.7	28	50x50	84	55x47x86
50-315(I)B/4	3	4	10	21	50x50	82	55x44x83
65-125(A)	0.55	0.75	12.5	5	65x65	41	34x28x55
65-160(A)	0.75	1	12.5	8	65x65	46	36x31x57
65-160(A/4)	0.55	0.75	11	6	65x65	35	36x31x57
65-200(A)	1.1	1.5	12.5	12.5	65x65	52	38x35x64
65-200(A/4)	0.75	1	11.2	10	65x65	48	38x35x64
65-250(A/4)	2.2	3	12.5	20	65x65	76	48x44x79
65-250(A)	1.5	2	11.7	17.5	65x65	68	48x44x79
65-250B/4	1.1	1.5	10	13	65x65	63	48x44x79
65-315(A)	4	5.5	12.5	32	65x65	89	55x51x92
65-315(A/4)	3	4	11.7	28	65x65	85	55x47x86
65-315B/4	3	4	10	21	65x65	82	55x44x83
65-125(I)A/4	0.75	1	25	5	65x65	49	40x36x66
65-160(I)/4	1.1	1.5	25	8	65x65	54	40x36x66
65-160(I)A/4	0.75	1	22	6	65x65	48	40x36x66
65-200(I)/4	2.2	3	25	12.5	65x65	71	45x43x80
65-200(I)A/4	1.5	2	23.3	11	65x65	62	45x43x80
65-250(I)/4	3	4	25	20	65x65	85	48x47x87
65-250(I)A/4	3	4	22.2	15.8	65x65	80	48x43x85
65-250(I)B/4	2.2	3	20	12.8			

TECHNICAL DATA/DATOS TÉCNICOS/DONNÉES TECHNIQUES

MODEL MODELO MODELE	Power Potencia Puissance		Flow Caudal Débit	Head Altura Hauteur	DN	Wt	Dim
	kw	hp					
125-315A/4	11	15	95	27	125x125	282	68x69x135
125-315B/4	11	15	87	24	125x125	245	68x69x135
125-400/4	30	40	100	50	125x125	375	71x54x105
125-400A/4	22	30	94	44	125x125	295	71x54x105
125-400B/4	18.5	25	87	37.5	125x125	257	71x54x100
125-200(I)/4	11	15	200	12.5	125x125	244	68x44x64
125-200(I)A/4	7.5	10	179	10	125x125	210	68x42x62
125-250(I)/4	15	20	200	20	125x125	265	68x42x91
125-250(I)A/4	11	15	184.4	17	125x125	241	68x42x91
125-250(I)B/4	7.5	10	167	14	125x125	210	68x42x85
125-315(I)/4	22	30	200	32	125x125	335	74x47x98
125-315(I)A/4	18.5	25	187	28	125x125	315	74x44x95
125-315(I)B/4	15	20	173	24	125x125	265	74x44x95
125-400(I)/4	45	60	200	50	125x125	490	78x57x107
125-400(I)A/4	37	50	187	44	125x125	454	78x56x105
125-400(I)B/4	30	40	160	38	125x125	435	78x56x105
150-200/4	15	20	200	12.5	150x150	265	68x44x93
150-200A/4	11	15	179	10	150x150	244	68x44x89
150-250/4	18.5	25	200	20	150x150	300	70x48x96
150-250A/4	15	20	184.4	17	150x150	262	70x48x94
150-250B/4	11	15	167	14	150x150	241	70x45x90
150-315/4	30	40	200	32	150x150	410	76x53x108
150-315A/4	22	30	187	28	150x150	335	76x51x100
150-315B/4	18.5	25	173	24	150x150	315	76x51x96
150-400/4	45	60	200	50	150x150	490	80x60x112
150-400A/4	37	50	187	44	150x150	454	80x60x110
150-400B/4	30	40	174	38	150x150	435	80x56x108
150-400C/4	22	30	160	32	150x150	365	80x54x100
150-200(I)/4	15	20	200	12.5	150x150	265	68x44x93
150-200(I)A/4	11	15	179	10	150x150	244	68x44x89
150-250(I)/4	18.5	25	200	20	150x150	305	75x48x96
150-250(I)A/4	15	20	187	17.5	150x150	267	75x48x94
150-250(I)B/4	11	15	173	14	150x150	246	75x45x90
150-315(I)/4	30	40	200	32	150x150	417	80x53x108
150-315(I)A/4	22	30	187	28	150x150	342	80x51x100
150-315(I)B/4	18.5	25	173	24	150x150	322	80x51x96
150-400(I)/4	45	60	200	50	150x150	498	86x60x112
150-400(I)A/4	37	50	187	44	150x150	462	86x60x110
150-400(I)B/4	30	40	173	37.5	150x150	443	86x56x108
150-400(I)C/4	22	30	160	32	150x150	373	86x54x100
200-200/4	15	20	200	12.5	200x200	265	68x44x93
200-200A/4	11	15	179	10	200x200	244	68x44x89
200-250/4	18.5	25	200	20	200x200	305	75x48x96
200-250A/4	15	20	184.4	17	200x200	267	75x48x94
200-250B/4	11	15	179	14	200x200	246	75x45x90
200-315/4	30	40	200	32	200x200	417	80x53x108
200-315A/4	22	30	187	28	200x200	342	80x51x100
200-315B/4	18.5	25	173	24	200x200	322	80x51x96
200-400/4	45	60	200	50	200x200	498	86x60x112

50 Hz n=1450 1/min

MODEL MODELO MODELE	Power Potencia Puissance		Flow Caudal Débit	Head Altura Hauteur	DN	Wt	Dim
	kw	hp					
200-400A/4	37	50	187	44	200x200	462	86x60x110
200-400B/4	30	40	174	38	200x200	443	86x56x108
200-400C/4	22	30	160	32	200x200	373	86x54x100
200-200(I)/4	22	30	400	12.5	200x200	382	81x53x103
200-200(I)A/4	18.5	25	358	10	200x200	346	81x53x97
200-250(I)/4	30	40	400	20	200x200	475	83x53x111
200-250(I)A/4	22	30	358	16	200x200	405	83x51x104
200-250(I)B/4	18.5	25	322	13	200x200	387	83x51x100
200-315(I)/4	55	75	400	32	200x200	675	86x65x127
200-315(I)A/4	45	60	374	28	200x200	560	86x63x118
200-315(I)B/4	37	50	346	24	200x200	535	86x63x115
200-400(I)/4	75	100	400	50	200x200	830	88x70x134
200-400(I)A/4	75	100	374	44	200x200	830	88x70x134
200-400(I)B/4	55	75	346	38	200x200	685	88x64x127
200-400(I)C/4	45	60	320	32	200x200	580	88x60x119
250-250/4	45	60	550	20	250x250	620	111x55x115
250-250A/4	37	50	500	17	250x250	550	111x55x115
250-315/4	75	100	550	32	250x250	890	111x64x135
250-315A/4	55	75	500	28	250x250	690	111x64x135
250-315B/4	45	60	450	24	250x250	620	111x64x135
250-400/4	110	150	500	50	250x250	1530	120x90x156
250-400A/4	90	120	500	44	250x250	1320	120x90x146
250-400B/4	75	100	450	38	250x250	950	120x90x136
250-500/4	200	270	550	80	250x250	2000	130x90x192
250-500A/4	160	215	506	71	250x250	1850	130x90x173
250-500B/4	132	176	466	63.5	250x250	1750	130x90x169
300-250/4	55	75	720	20	300x300	690	125x60x151
300-250A/4	45	60	600	17	300x300	620	125x60x142
300-315/4	90	120	720	32	300x300	1320	100x67x153
300-315A/4	75	100	650	28	300x300	950	100x67x148
300-315B/4	55	75	580	24	300x300	750	100x67x148
300-400/4	110	150	720	50	300x300	1530	150x67x177
300-400A/4	110	150	637	44	300x300	1530	150x67x173
300-400B/4	90	120	563	38	300x300	1320	150x67x170
300-400C/4	75	100	561	33	300x300	950	150x67x153
300-500/4	250	335	720	80	300x300	2300	150x90x196
300-500A/4	200	270	675	70	300x300	2000	150x90x196
300-500B/4	160	215	625	60	300x300	1850	150x90x196
350-315/4	90	120	800	32	350x350	1650	130x68x140
350-315A/4	75	100	1080	17	350x350	1250	130x68x140
350-400/4	160	215	800	50	350x350	1950	130x68x182
350-400A/4	132	176	1080	28	350x350	1750	130x68x172
350-315(I)/4	160	215	1200	32	350x350	1950	130x68x182
350-315(I)A/4	132	176	1092	28	350x350	1750	130x68x172
350-315(I)B/4	110	150	994	25	350x350	1530	130x68x182
350-400(I)/4	250	335	1200	50	350x350	2300	130x68x182
350-400(I)A/4	250	335	1092	44	350x350	2300	130x68x182
350-400(I)B/4	200	270	994	38.5	350x350	2000	130x68x172

MATERIAL DESCRIPTION/DESCRIPCIÓN DE MATERIAL/DESCRIPTION DU MATÉRIEL

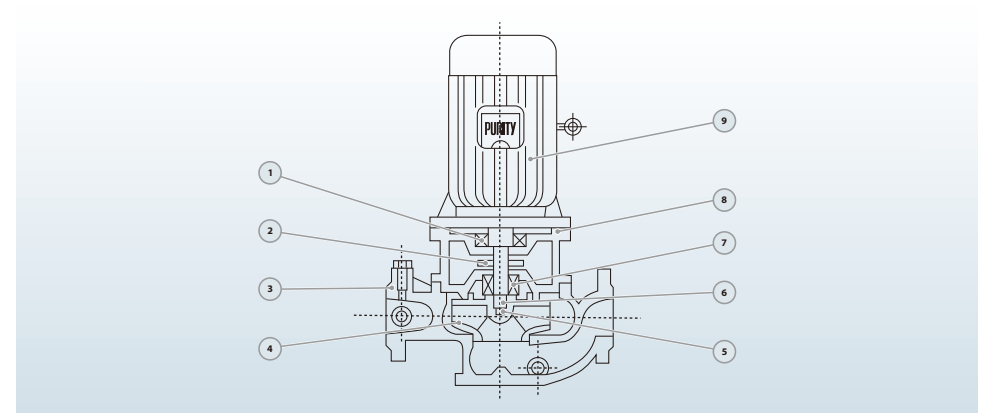

No.	Description Descripción Description	Material Material Matériel	No.	Description Descripción Description	Material Material Matériel	No.	Description Descripción Description	Material Material Matériel
1	Bearing Rodamiento Palier	Ball Bearing Bola Rodamiento Palier-Balle	4	Impeller Impulsor Roue	SS304/Cast iron Inox 304/Fundición Inox 304/Fonte	7	Mechanical Seal Cierre Mecánico Sceller	SiC/Carbon/SS304 SiC/Grafito/Inox304 SiC/Carbon/Inox304
2	Water Deflector Deflector Déflecteur	Rubber Caucho Caoutchouc	5	Impeller Nut Nuez Noix	Galvanized Steel Acero Galvanizado Acier Galvanisé	8	Connection Conexión Lien	Cast iron Fundición Fonte
3	Pump Case Cuerpo de Bomba Boîtier de pompe	Cast iron Fundición Fonte	6	Shaft Eje Arbre	SS304-45# Steel Inox 304-Hierro Inox304-Acier	9	Motor Motor Moteur	IP55 Class F IP55 Clase F IP55 Classe F

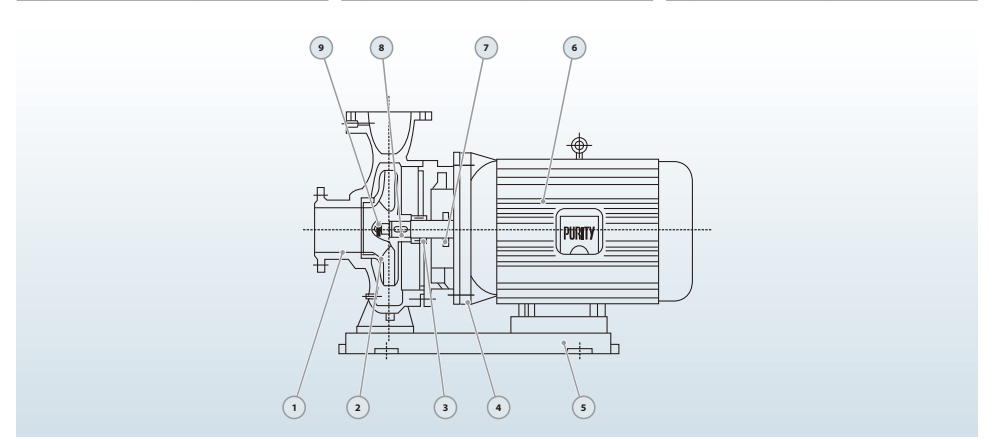

No.	Description Descripción Description	Material Material Matériel	No.	Description Descripción Description	Material Material Matériel	No.	Description Descripción Description	Material Material Matériel
1	Pump Case Cuerpo de Bomba Boîtier de pompe	Cast iron Fundición Fonte	4	Connection Conexión Lien	Cast iron Fundición Fonte	7	Water Deflector Deflector Déflecteur	Rubber Caucho Caoutchouc
2	Impeller Impulsor Roue	SS304/Cast iron Inox 304/Fundición Inox 304/Fonte	5	Base Base Base	Cast iron Fundición Fonte	8	Shaft Eje Arbre	SS304-45# Steel Inox 304-Hierro Inox304-Acier
3	Mechanical Seal Cierre Mecánico Sceller	SiC/Carbon/SS304 SiC-Grafito-Inox304 SiC/Carbon/Inox304	6	Motor Motor Moteur	IP55 Class F IP55 Clase F IP55 Classe F	9	Impeller Key Chaveta Clé	Iron Hierro Le fer



PSC

Double suction split case pump Succión doble bomba de cámara partida Pompe à double corps d'aspiration

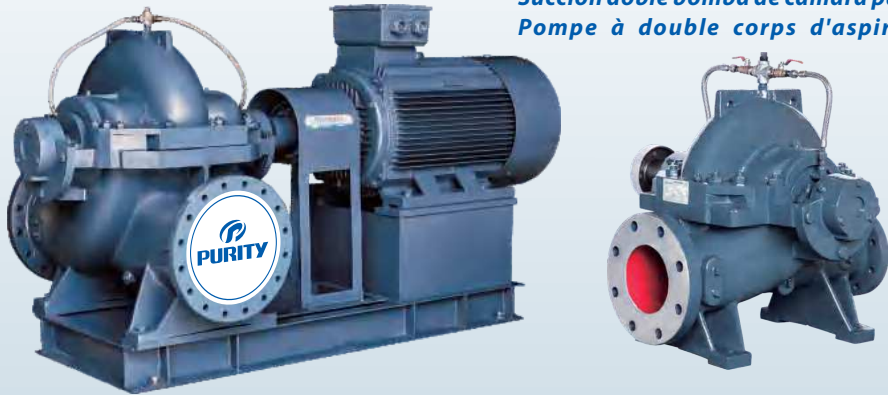

NEW/NUEVO/NOUVEAU

DESCRIPTION/DESCRIPCIONES/DESCRIPTION

- ♦ Axially split volute pump casing design
- ♦ Pump case with anti-corrosive coating HT250
- ♦ Double-entry radial impeller in AISI 304 or HT250
- ♦ Shaft protecting sleeves in the seal area
- ♦ Mechanical seal and gland packing are both available
- ♦ Grease-packed rolling element bearings sealed for life
- ♦ Reliable complete with motor or diesel for fire fighting etc.

- ♦ Diseño de carcasa de bomba de voluta dividida axialmente
- ♦ Caja de bomba con recubrimiento anticorrosivo HT250
- ♦ Impulsor radial de doble entrada en inox304 o HT250
- ♦ Mangas de protección del eje en el área del sello
- ♦ El sello mecánico y el empaque de la glándula están disponibles
- ♦ Rodamientos de elementos rodantes rellenos de grasa
- ♦ Completamente confiable con motor o diesel para incendios etc.

- ♦ Conception de corps de pompe à volute divisée axialement
- ♦ Carter de pompe avec revêtement anti-corrosif HT250
- ♦ Roue radiale à double entrée en inox304 ou HT250
- ♦ Manchons de protection d'arbre dans la zone d'étanchéité
- ♦ Le joint mécanique et le presse-étoupe sont disponibles
- ♦ Roulements d'éléments roulants graissés scellés à vie
- ♦ Fiable complet avec moteur ou diesel pour la lutte l'incendie etc.

USING LIMITS/LÍMITES UTILIZACIÓN/UTILISATION LIMITES

- ♦ Ambient temperature between 0°C and +50°C
- ♦ Max. working pressure 25 bar/Continuous S1
- ♦ Temperatura del líquido de -10 °C hasta +120 °C
- ♦ Temperatura ambiente de 0 °C hasta +50 °C
- ♦ Presión máxima 25 bar/Continuo S1
- ♦ Température du liquide entre -10 °C et +120 °C
- ♦ Température ambiante entre 0 °C et +50 °C
- ♦ Max. pression de service 25 bar/Continu S1

MODEL CODE/CÓDIGO MODELO/CODE MODÈLE

For example/Par ejemplo/Par exemple

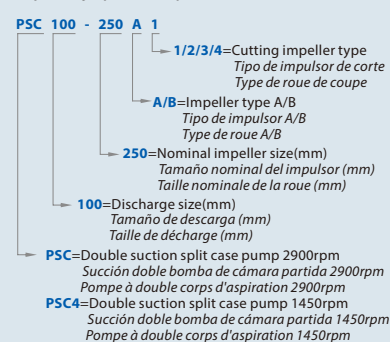

TECHNICAL DATA/DATOS TÉCNICOS/DONNÉES TECHNIQUES PSC 50 Hz n=2900 1/min

MODEL MODELO MODÈLE	Flow Range Rango de Caudal Gamme de débit m³/h	Head Range Rango de Altura Gamme de tête m	Power Range Rango de Potencia Gamme de puissance kw	DN mm
80-210A1	131-164-197	60.5-55-50	26.8-29.9-33.4	125x80
80-210A2	121-151-181	52-47.5-42.2	21.6-24.1-26.1	125x80
80-210A3	115-144-173	44-39-35	17.8-19-21.1	125x80
80-210A4	110-137-164	37-33.5-27.7	14.7-16-16.7	125x80
80-210B1	107-134-160	55.5-51-46	20.5-22.9-25.1	125x80
80-210B2	106-133-159	47.7-43.5-37	17.6-19.3-20	125x80
80-210B3	100-124-149	40-36-30	14.4-15.6-16.5	125x80
80-210B4	91-113-136	35-31-27	12.1-12.9-13.9	125x80
80-270A1	166-207-248	97.5-90-79	57-64.6-70.8	125x80
80-270A2	156-194-233	83.5-77-69	46.6-52.6-58.1	125x80
80-270A3	147-184-220	70-63.5-55	37.5-41.8-44.6	125x80
80-270A4	138-173-198	56.5-50-45	28.7-31.4-32.8	125x80
80-270B1	137-171-205	91-82.5-72.5	44.6-49.9-54.1	125x80
80-270B2	122-153-184	79.5-71.5-67	35.6-39.1-44.7	125x80
80-270B3	115-144-173	66.8-60-53	28.5-31.3-33.7	125x80
80-270B4	110-137-164	54.5-49-42	22.4-24.5-25.9	125x80
100-250A1	230-288-346	83-75-67	64.2-70.9-78.4	150x100
100-250A2	219-274-328	69-63-55	51.9-58.3-62.3	150x100
100-250A3	209-261-313	59-52-46.5	43.5-46.8-51.5	150x100
100-250A4	193-240-290	49-45-37	33.9-37.7-39.2	150x100
100-250B1	196-245-294	75-68-59	50-55.6-59.8	150x100
100-250B2	180-223-268	65-59-51	40.6-44.7-47.9	150x100
100-250B3	165-205-246	56-51-44	32.9-36.8-38.8	150x100
100-250B4	150-190-227	48-43-38	26.4-29.1-31.1	150x100
100-310A1	294-367-440	135-123-105	137.7-153.8-164	150x100
100-310A2	268-335-402	116-106-92	108-121.4-131	150x100
100-310A3	242-302-363	98-90-80	82.7-93.5-102.5	150x100
100-310A4	182-227-333	86-81-63	62-68-76	150x100
100-310B1	226-283-340	130-119-105	105-117.4-128.5	150x100
100-310B2	208-260-310	111-103-90	81.8-93.7-100	150x100
100-310B3	200-250-300	92-84-74	65.8-72.8-80.5	150x100
100-310B4	187-234-281	78-69-60	53.1-57.1-61.2	150x100
125-230A1	426-541-639	68-60-48	93.8-101.8-101.9	200x125
125-230A2	392-490-585	60-52-43.5	78.1-82.1-84.4	200x125
125-230A3	363-454-544	50-43.5-35	63.4-65.1-66.6	200x125
125-230A4	340-425-489	40-34-30	49.4-50.8-52.5	200x125
125-230B1	377-472-566	68-60.5-51	84.2-92-101.5	200x125
125-230B2	349-436-523	60-53-44	70.3-74.8-77.2	200x125
125-230B3	328-410-493	52-45-37	60.1-61.3-63.3	200x125
125-230B4	305-382-458	42.5-37-30	47.1-49.9-49.9	200x125
125-290A1	428-535-642	117-108-95	166-187-202	200x125
125-290A2	397-497-596	97-88-75	131-145-153	200x125
125-290A3	363-454-544	80-72-62	101-111-117	200x125
125-290A4	323-403-484	65-57-47	74.7-80.2-80.5	200x125
125-290B1	383-480-575	113-100-85.5	145-157-166	200x125
125-290B2	348-436-523	93.5-83.5-70	112-121-126	200x125
125-290B3	308-385-462	78-70-60	84.5-93-96.9	200x125
125-290B4	274-342-410	60-55-47	59.6-67.4-70	200x125

PSC 50 Hz n=1450 1/min

MODEL MODELO MODÈLE	Flow Range Rango de Caudal Gamme de débit m³/h	Head Range Rango de Altura Gamme de tête m	Power Range Rango de Potencia Gamme de puissance kw	DN mm
80-210A1	66-83-100	15-13.8-12.2	3.4-3.8-4.2	125x80
80-210A2	61-76-90	13-11.8-10.5	2.7-3-3.3	125x80
80-210A3	58-72-87	11-9.8-8.7	2.2-2.4-2.6	125x80
80-210A4	55-69-83	9.1-8.2-7	1.8-2-2.1	125x80
80-210B1	52-65-78	14.2-12.8-10	2.6-2.8-3.1	125x80
80-210B2	52-64-77	12-10.8-11.7	2.1-2.4-3.1	125x80
80-210B3	50-61-73	10-9-7.8	1.8-1.9-2	125x80
80-210B4	47-58-70	8.7-7.6-6.5	1.5-1.6-1.8	125x80
80-270A1	83-104-125	24-22.5-19.5	7-8.1-8.8	125x80
80-270A2	80-99-120	21.3-19-17	6.1-6.6-7.4	125x80
80-270A3	72-90-108	17.5-16-13.7	4.6-5.2-5.4	125x80
80-270A4	67-84-100	13.8-13-11.5	3.4-4-4.3	125x80
80-270B1	68-85-102	23.1-20.7-18.2	5.7-6.2-6.7	125x80
80-270B2	61-77-92	20-18.1-16	4.5-5-5.3	125x80
80-270B3	58-72-86	16.5-15-13.2	3.5-3.9-4.2	125x80
80-270B4	53-67-80	13.8-12.5-10.8	2.7-3.1-3.2	125x80
80-370A1	90-113-136	42-38.8-33.5	14.8-16.2-17.3	125x80
80-370A2	80-99-120	35-33-29.1	10.6-12.1-13.3	125x80
80-370A3	70-88-106	29.3-27.5-24.7	8.2-9.4-10.2	125x80
80-370A4	65-81-98	23.8-22.5-20	6.4-7-7.8	125x80
80-370B1	80-99-120	38.8-35.5-31.3	11.8-13.1-14.3	125x80
80-370B2	72-90-108	34.1-30.8-26.3	9.7-10.8-11.4	125x80
80-370B3	60-76-90	27.5-25.5-22.5	7-8-8.5	125x80
80-370B4	53-67-80	21.3-20-17.5	4.9-5.7-6	125x80
100-250A1	115-144-173	21.2-18.8-17.5	8.2-8.9-10	150x100
100-250A2	112-140-167	17.5-15.8-13.2	6.7-7-7.4	150x100
100-250A3	100-126-150	14.5-13.5-11.9	5.1-5-5.6	150x100
100-250A4	97-120-145	12.2-11.2-9.5	4.2-4-7.5	150x100
100-250B1	98-122-147	18.8-17-15	6.2-7-7.6	150x100
100-250B2	90-112-135	16.3-14.5-12.7	5.1-5-6	150x100
100-250B3	85-106-128	13.7-12.5-11.3	4.1-4-7-5.3	150x100
100-250B4	75-94-113	12.1-11-9.6	3.3-3-7-3.9	150x100
100-310A1	148-185-222	34-31-26.8	17.4-19.6-21	150x100
100-310A2	133-166-200	29.3-27-24.3	13.4-15.3-17	150x100
100-310A3	120-151-180	24.8-22.5-20	10.5-11.7-12.8	150x100
100-310A4	112-140-162	20.2-18.5-16.2	7.9-9-9.2	150x100
100-310B1	112-140-168	32.5-29.5-25	13-14.1-15.5	150x100
100-310B2	106-133-160	27.5-25-22	10.4-11.6-12.8	150x100
100-310B3	100-124-150	23-21.2-18	8.2-9-9.8	150x100
100-310B4	94-117-140	19.4-17-15	6.5-6.9-7.6	150x100
100-375A1	148-185-220	57-51-44.2	31.4-33.5-36	150x100
100-375A2	133-167-200	47.3-46-38	24.5-28.3-29.2	150x100
100-375A3	124-155-186	41-38-31	20.3-22.6-23.1	150x100
100-375A4	108-135-162	32.5-30.3-25.3	14.4-14.5-16.8	150x100
100-375B1	130-162-195	56.2-52-45.8	28.4-31.4-35.9	150x100
100-375B2	114-142-170	47.5-44-39	22.2-23.7-27.3	150x100
100-375B3	105-130-157	40-37.5-32.5	17.7-18.8-21.7	150x100
100-375B4	92-115-138	30.8-28.7-25	12.7-14.3-15.4	150x100

TECHNICAL DATA/DATOS TÉCNICOS/DONNÉES TECHNIQUES
PSC4 50 Hz n=1450 1/min

MODEL MODELO MODÈLE	Flow Range Rango de Caudal Gamme de débit	Head Range Rango de Altura Gamme de tête	Power Range Rango de Potencia Gamme de puissance	DN
	m ³ /h	m	kw	mm
125-230A1	220-274-328	17-14.8-12	12.1-12.9-13.1	200x125
125-230A2	193-241-290	15-13.2-10.8	9.7-10.3-10.4	200x125
125-230A3	184-230-277	12.6-10.6-8	8-8.1-8.1	200x125
125-230A4	167-209-250	10.3-8.7-6.8	6.4-6.4-6.4	200x125
125-230B1	190-238-307	17-15.1-11.5	10.5-11.6-12	200x125
125-230B2	170-212-255	15-13.5-11.4	8.6-9.3-9.7	200x125
125-230B3	164-205-246	13-11.5-9.2	7.5-7.8-7.9	200x125
125-230B4	156-195-223	10.5-9.1-7.7	5.9-6.2-6.3	200x125
125-290A1	215-269-323	29.2-27-23.5	20.8-23.6-25.2	200x125
125-290A2	195-243-292	24.4-22-19.6	16.1-17.8-19.5	200x125
125-290A3	178-223-268	20-18-15.5	12.3-13.7-14.4	200x125
125-290A4	161-202-242	16.3-14.2-11.8	9.3-10-10.2	200x125
125-290B1	193-241-290	27.5-25-21.3	17.8-19.8-20.6	200x125
125-290B2	174-218-261	23.4-21-17.5	13.9-15.2-16	200x125
125-290B3	157-196-235	19-17.5-15	10.4-11.8-12.3	200x125
125-290B4	138-173-207	15.1-13.7-11.3	7.7-8.5-8.6	200x125
125-365A1	245-310-360	50-47-44	41.2-47.2-52.3	200x125
125-365A2	225-281-337	41.6-39-35.6	31.8-36-40.4	200x125
125-365A3	205-256-307	33.7-31.5-28.2	24.2-26.8-29.8	200x125
125-365A4	184-230-278	25.5-24-20.9	16.9-18.8-20.2	200x125
125-365B1	222-277-333	46.3-43-38.8	35.4-40.1-44	200x125
125-365B2	202-252-302	39.8-37-32.8	28-31.8-34.2	200x125
125-365B3	182-227-272	32.6-30.5-27.5	21.4-24.5-26.8	200x125
125-365B4	158-198-238	26.3-24.5-21.8	14.9-17.4-18.8	200x125
125-500A1	262-328-393	82-76-70	73.7-82.7-96.4	200x125
125-500A2	233-292-342	70-66.5-62	56.7-67.3-74.8	200x125
125-500A3	205-256-307	60-56-51.5	44-50.6-56.6	200x125
125-500A4	184-230-252	50-47-45	34.2-38.8-40.7	200x125
125-500B1	235-293-352	75-69.5-63	61.7-70.3-78.5	200x125
125-500B2	217-272-326	65-60.5-55	50.1-57.4-64.3	200x125
125-500B3	181-227-272	57-53-48.3	37.5-42.5-47.3	200x125
125-500B4	161-202-234	47.5-45-40	28.2-32.5-34.5	200x125
150-290A1	354-443-531	24-21-17.5	27.1-29.1-30.3	200x150
150-290A2	323-403-484	21-18-15	22.2-23-24	200x150
150-290A3	302-378-454	17.5-15-12.3	18-18.4-19.1	200x150
150-290A4	280-350-396	13.7-11.5-10	13.9-14.2-14.2	200x150
150-290B1	317-396-475	23.4-20.4-16.6	24-25.6-25.7	200x150
150-290B2	302-378-454	20-17-13.7	19.9-20.6-20.7	200x150
150-290B3	282-353-423	17.5-14.5-11.3	16.6-16.6-16.5	200x150
150-290B4	265-331-378	14-11.5-9.8	13-13-13.3	200x150
150-360A1	357-446-536	41.3-38-34.2	38.4-54.3-60.4	200x150
150-360A2	323-403-484	34.2-31-26.3	34.6-51-41.2-9	200x150
150-360A3	298-370-445	28.7-25-21	29.4-31.2-32.3	200x150
150-360A4	265-331-398	23.4-20-16.7	22.1-21.1-23.3	200x150
150-360B1	325-407-488	39.2-35-30	42.3-46.2-49.3	200x150
150-360B2	294-367-440	33-29-25	32.8-36-37.5	200x150
150-360B3	267-334-400	27.5-25-21.3	25.4-28.5-29.8	200x150
150-360B4	233-292-350	22.8-20.5-17.5	19.2-20-22	200x150
150-460A1	412-515-618	71-66-60	99.4-112.8-126.2	200x150
150-460A2	377-472-566	58-54.5-48	75.2-86.4-94.9	200x150
150-460A3	346-432-516	47.5-43.5-37	57-64-69-37	200x150
150-460A4	317-396-475	38-35-28.2	42.6-48-50.7	200x150
150-460B1	350-440-527	65-60-53.5	78.3-88.6-97.6	200x150
150-460B2	323-403-484	54-50-44.5	60.3-68.2-75.2	200x150
150-460B3	300-375-450	44.4-40-34.5	46.5-51-57.1	200x150
150-460B4	260-324-390	35.5-33-28.4	33.5-37.3-40.7	200x150
150-605A1	467-583-700	112-105-95.5	182.6-206-233.4	200x150
150-605A2	440-550-648	96-98.5-81	151.1-168-187.5	200x150
150-605A3	412-515-605	82-75-68	120-134.8-151.4	200x150
150-605A4	378-472-526	67.5-61.5-55.2	92.3-102.6-106.8	200x150

PSC4 50 Hz n=1450 1/min

MODEL MODELO MODÈLE	Flow Range Rango de Caudal Gamme de débit	Head Range Rango de Altura Gamme de tête	Power Range Rango de Potencia Gamme de puissance	DN
	m ³ /h	m	kw	mm
150-605B1	430-536-617	98-90-82	149.2-166.4-181.5	200x150
150-605B2	392-490-576	85-78-70	118.9-133.3-148.1	200x150
150-605B3	357-446-535	75-68.5-60	96.2-108.2-118.4	200x150
150-605B4	323-403-484	62.5-57.5-50	73.4-83.1-91.6	200x150
200-320A1	556-695-834	34-30-25	60-64.9-67.2	250x200
200-320A2	518-648-778	29-25.5-21.3	48.8-52-54	250x200
200-320A3	481-601-720	25-21.3-17.2	40.7-41-42.3	250x200
200-320A4	440-550-612	18.9-17-15.3	29-32.3-32.9	250x200
200-320B1	510-637-765	32.3-28-23.4	52.7-56.2-58	250x200
200-320B2	475-594-713	28.5-24.5-20	44-46.1-46.9	250x200
200-320B3	445-558-670	23.8-21-17.2	35.6-38-38.4	250x200
200-320B4	415-515-595	20-17-14.2	28.8-29.1-29.5	250x200
200-420A1	567-709-850	57-52-47	104-116-129	250x200
200-420A2	504-630-756	47.5-42.5-37.5	79.1-86.3-93.1	250x200
200-420A3	458-572-687	40-35-30	62-66.7-68.8	250x200
200-420A4	409-511-613	32.5-27.5-24	45.8-49-50.1	250x200
200-420B1	518-648-778	54-48.5-42	90.8-99.1-107	250x200
200-420B2	467-583-700	45-40-35	69.8-76.6-81.9	250x200
200-420B3	423-530-635	38-34.5-29	54.8-60.6-63.1	250x200
200-420B4	375-468-562	31.5-28-24	41.5-45.8-47.5	250x200
200-520A1	654-817-980	97-91-83	210-241-272	250x200
200-520A2	605-756-907	82.5-76.5-70	170-192-215	250x200
200-520A3	565-706-847	67-62.5-55	132-148-163	250x200
200-520A4	518-647-778	52.3-47.5-42	98-107-117	250x200
200-520B1	558-734-880	88-81.7-73.2	175-197-219	250x200
200-520B2	556-695-834	74-68-60	141-159-172	250x200
200-520B3	524-655-786	60-55-48.8	109-123-134	250x200
200-520B4	478-598-717	48-43-35.8	81-91-98	250x200
200-670A1	634-792-936	157.5-150-140	350-404-457	250x200
200-670A2	596-745-894	134.5-127-114.5	285-328-367	250x200
200-670A3	562-702-842	114.5-107-95.5	231-266-293	250x200
200-670A4	527-659-770	95.5-88-80	183-208-227	250x200
200-670B1	576-720-864	142-132-120	289-329-372	250x200
200-670B2	530-662-795	123-114.5-104	231-263-296	250x200
200-670B3	493-616-720	106-98.5-90	187-212-232	250x200
200-670B4	455-569-683	90-83-73	149-167-184	250x200
250-370A1	840-1051-1260	44-39-33.5	118-127-137	300x250
250-370A2	795-994-1192	37.5-33-27.7	99-104-109	300x250
250-370A3	755-943-1131	31.5-27-21	83-83.6-83.6	300x250
250-370A4	756-871-1008	23-20-16	62.3-61.2-57.8	300x250
250-370B1	823-1029-1235	42.3-37-31	112-119-124	300x250
250-370B2	775-968-1162	37-32-27	94.9-98.1-103.6	300x250
250-370B3	732-914-1097	32-27-22	79.7-80-82.2	300x250
250-370B4	680-850-1020	25.6-22-17	61.6-62.1-61.3	300x250
250-480A1	938-1173-1408	73.5-66-58	222-239-262	300x250
250-480A2	864-1080-1296	60.5-55-47.5	166-188-202	300x250
250-480A3	800-1000-1200	50-45-38	136-149-160	300x250
250-480A4	743-929-1115	42-37-35	110-119-126	300x250
250-480B1	864-1044-1296	62-55-45	177-191-199	300x250
250-480B2	780-976-1171	53.5-47-42	141-149-163	300x250
250-480B3	708-886-1063	45-40-34	111-121-126	300x250
250-480B4	642-803-963	40-34.5-28.5	94.6-96.1-98.4	300x250
250-600A1	994-1242-1490	126-116-105	411-467-520	300x250
250-600A2	933-1166-1400	108-100-90	333-380-421	300x250
250-600A3	867-1084-1300	90-83-73.5	262-295-322	300x250
250-600A4	800-1000-1200	74-66-60	201-218-244	300x250
250-600B1	835-1044-1253	114-104-91.5	320-356-381	300x250
250-600B2	772-965-1158	98-90-80	255-287-311	300x250
250-600B3	700-875-1050	80.3-74.5-66	192-218-235	300x250
250-600B4	640-800-960	67.5-62-56.5	149-168-186	300x250

TECHNICAL DATA/DATOS TÉCNICOS/DONNÉES TECHNIQUES
PSC4 50 Hz n=1450 1/min

MODEL MODELO MODÈLE	Flow Range Rango de Caudal Gamme de débit	Head Range Rango de Altura Gamme de tête	Power Range Rango de Potencia Gamme de puissance	DN
	m ³ /h	m	kw	mm
250-710A1	904-1130-1356	184-175-164	579-674-775	300x250
250-710A2	782-978-1174	161-152-141	444-513-578	300x250
250-710A3	738-922-1106	136-128-118	358-415-465	300x250
250-710A4	692-865-1038	113-106-99	280-325-360	300x250
300-300A1	878-1098-1318	28.8-24.5-20	83.8-85.2-89.4	350x300
300-300A2	835-1044-1253	23.5-19.8-15	66.4-66.6-63.2	350x300
300-300A3	806-1008-1210	19-15.5-11.4	52.8-51.9-48.2	350x300
300-300A4	772-965-1158	15-11.5-7.5	41.5-37.8-32	350x300
300-300B1	745-936-1123	26.2-23-20	64.4-69-72.9	350x300
300-300B2	691-864-1037	24-20-15.8	56.2-56-55.1	350x300
300-300B3	639-800-960	20-16-17-13.5	45.5-44.9-44.6	350x300
300-300B4	560-700-840	17.5-15-12	37.1-37.1-36.1	350x300
300-435A1	1342-1677-2012	60-53-46	257-275-295	400x300
300-435A2	1262-1577-1892	52-45-37.5	213-223-230	400x300
300-435A3	1181-1476-1771	42.5-36.5-28.5	171-175-172	400x300
300-435A4	1088-1360-1530	33.8-27.5-24	132-129-128	400x300
300-435B1	1396-1620-1944	57.5-51.5-43.5	240-260-273	400x300
300-435B2	1215-1519-1823	51.5-45-37.5	206-215-222	400x300
300-435B3	1138-1422-1706	43.5-37.5-30	168-173-174	400x300
300-435B4	1066-1332-1598	35-30-24.8	130-136-138	400x300
300-560A1	1397-1745-2095	101.5-94-83.5	454-520-570	400x300
300-560A2	1316-1645-1974	83.5-76-67	357-398-433	400x300
300-560A3	1258-1573-1888	68-63-54	281-313-339	400x300
300-560A4	1213-1516-1819	57-50-42	232-247-2	

MATERIAL DESCRIPTION/DESCRIPCIÓN DE MATERIAL/DESCRIPTION DU MATÉRIEL

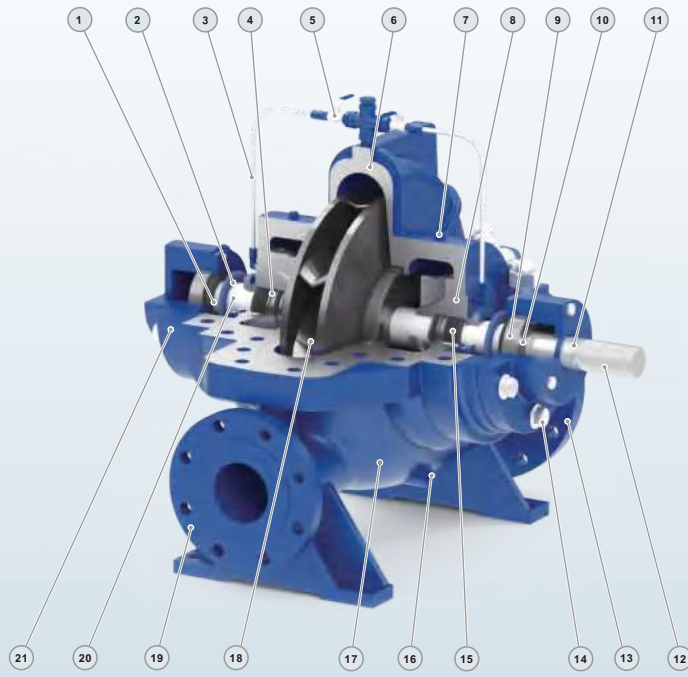

No.	Description Descripción Description	Material Material Matériel	No.	Description Descripción Description	Material Material Matériel	No.	Description Descripción Description	Material Material Matériel
1	Block ring Anillo de bloqueo Bague bloc	Rubber Caucho Caoutchouc	8	Seal house Casa de sello Maison du phoque	Cast iron Fundición Fonte	15	Gland seal(Mechanical Seal) Sello glándula(Cierre Mecánico) Joint étoupe (Joint mécanique)	Synthepak(SiC-Carbon) Synthepak(SiC-Grafito) Synthepak (SiC-Carbon)
2	O-ring Junta tórica Joint torique	Rubber Caucho Caoutchouc	9	Bearing Rodamiento Palier	Ball Bearing Bola Rodamiento Palier Balle	16	Release Valve Tapón Cebado Soupape de décharge	Brass Bronce Laiton
3	Flushing pipe Tubo de enjuague Tuyau de rinçage	SS304 Inox 304 Inox 304	10	Lock washer Arandela de bloqueo Rondelle frein	Steel Acero Acier	17	Pump Case Cuerpo de Bomba Boîtier de pompe	Cast iron Fundición Fonte
4	Packing ring Arandela Anneau d'emballage	Carbon Grafito Carbon	11	Shaft Eje Arbre	SS304/45# Steel Inox 304/45# Hierro Inox304/Acier	18	Impeller Impulsor Roue	SS304/Cast iron Inox 304/Fundición Inox 304/Fonte
5	Valve Valva Soupape	Brass Bronce Laiton	12	Shaft Key Chaveta Eje Clé d'arbre	Iron Hierro Le fer	19	Output flange Brida de salida Bride de sortie	Cast iron Fundición Fonte
6	Pump cover Tapa de bomba Couvercle de pompe	Cast iron Fundición Fonte	13	Input flange Brida de entrada Bride d'entrée	Cast iron Fundición Fonte	20	Shaft sleeve Manga de eje Manchon d'arbre	SS304 Inox 304 Inox 304
7	Vent plug Enchufe de ventilación Bouchon d'aération	Brass Bronce Laiton	14	Bolt Perno Boulon	Steel Acero Acier	21	Bearing house Casa de rodamiento Maison de roulement	Cast iron Fundición Fonte

DIMENSIONS AND WEIGHT/DIMENSIONES Y PESOS/DIMENSIONS ET POIDS

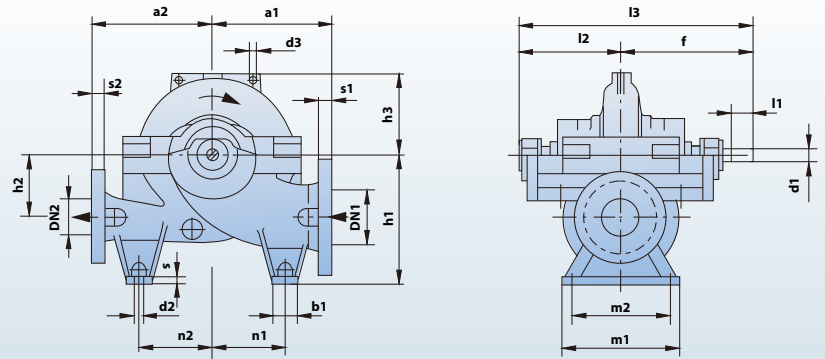

MODEL MODELO MODÈLE	DIMENSIONS/DIMENSIONES/DIMENSIONS mm																				kgs		
	DN1	DN2	s1	s2	a1	a2	d3	f	h1	h2	h3	l2	l3	b1	d2	m1	m2	n1	n2	s		d1	l1
80-210	125	80	34	29	300	300	19	415	315	140	168	300	715	70	17.5	320	270	170	170	20	35	80	185
80-270	125	80	34	29	300	300	19	415	315	140	190	300	715	70	17.5	320	270	170	170	20	35	80	195
80-370	125	80	34	29	330	330	19	415	315	140	225	300	715	70	17.5	320	270	170	170	20	35	80	205
100-250	150	100	37	32	330	330	19	415	355	170	195	300	715	70	17.5	320	270	200	200	20	35	80	210
100-310	150	100	37	32	330	330	19	415	355	170	225	300	715	70	17.5	320	270	200	200	20	35	80	225
100-375	150	100	37	32	370	370	19	415	355	170	260	300	715	70	17.5	320	270	200	200	20	35	80	245
125-230	200	125	41	35	370	370	19	515	400	200	210	366	881	70	17.5	390	340	225	225	20	45	100	250
125-290	200	125	41	35	370	370	19	515	400	200	230	366	881	70	17.5	390	340	225	225	20	45	100	275
125-365	200	125	41	35	370	370	19	515	400	200	260	366	881	70	17.5	390	340	225	225	20	45	100	300
125-500	200	125	41	35	450	450	19	515	400	200	305	366	881	70	17.5	390	340	280	280	20	45	100	335
150-290	200	150	41	37	400	400	19	515	400	200	245	366	881	70	17.5	390	340	225	225	20	45	100	350
150-360	200	150	41	37	400	400	19	515	400	200	265	366	881	70	17.5	390	340	225	225	20	45	100	360
150-460	200	150	41	37	450	450	19	590	400	200	305	399	989	70	17.5	480	430	280	280	20	55	125	440
150-605	200	150	41	37	600	500	19	590	500	300	370	399	989	70	17.5	480	430	350	380	20	55	125	650
200-320	250	200	48	41	450	450	24.5	590	500	240	285	399	989	70	17.5	480	430	280	280	20	55	125	450
200-420	250	200	48	41	500	500	24.5	590	500	240	310	399	989	70	17.5	480	430	280	280	20	55	125	520
200-520	250	200	48	41	600	500	24.5	655	560	300	370	464	1119	70	22	480	400	350	350	26	65	140	840
200-670	250	200	48	41	650	550	24.5	655	600	350	430	464	1119	100	22	480	400	350	350	26	65	140	990
250-370	300	250	33	32	500	500	12.5	655	600	300	320	464	1119	100	22	480	400	350	350	26	65	140	665
250-480	300	250	51	48	550	550	12.5	730	600	300	355	515	1245	100	22	600	520	350	350	26	75	160	830
250-600	300	250	51	48	650	550	12.5	730	630	350	415	515	1245	100	22	600	520	350	350	26	75	160	1215
300-300	350	300	36	33	550	500	24.5	655	630	300	360	464	1119	100	22	480	400	350	350	26	65	140	630
300-435	400	300	38	33	650	550	24.5	730	670	350	365	515	1245	100	22	600	520	350	350	26	75	160	905
300-560	400	300	57	51	700	650	24.5	810	710	350	430	585	1395	100	22	600	520	475	475	26	85	180	1425
300-700	400	300	57	51	750	650	24.5	810	750	400	480	585	1395	100	22	600	520	475	475	26	85	180	1690
350-360	400	350	38	36	650	550	24.5	730	670	350	410	515	1245	100	22	600	520	350	350	26	75	160	865
350-430	450	350	41	36	750	650	24.5	810	750	400	465	585	1395	100	22	600	520	475	475	26	85	180	1285
350-510	400	350	38	36	700	650	24.5	810	750	400	420	585	1395	100	22	600	520	475	475	26	85	180	1395



PXZ

Self-priming centrifugal pump Bomba centrífuga autocebante Pompe centrifuge auto-amorçante



NEW/NUEVO/NOUVEAU

DESCRIPTION/DESCRIPCIONES/DESCRIPTION

- ◆ New self-priming centrifugal pump design
- ◆ Original design by PURITY (patented no. 201530016935.4)
- ◆ YE3 high efficient motor, with protection IP55 class F
- ◆ Pump case with anti-corrosive coating
- ◆ Impeller in stainless steel AISI 304 or cast iron
- ◆ Suction and discharge port in G20 thread
- ◆ Quality NSK bearing, wear resistance mechanical seal
- ◆ Nuevo diseño de bomba centrífuga autocebante
- ◆ Diseño original de PURITY (patentado no. 201530016935.4)
- ◆ Motor de alta eficiencia YE3, con protección IP55 clase F
- ◆ Caja de bomba con revestimiento anticorrosivo
- ◆ Impulsor en acero inoxidable 304 o hierro fundido
- ◆ Puerto de succión y descarga en rosca G20
- ◆ Rodamiento de marca NSK y cierre mecánico personalizado
- ◆ Nouvelle conception de pompe centrifuge auto-amorçante
- ◆ Design original par PURITY (breveté no. 201530016935.4)
- ◆ Moteur haute efficacité YE3, avec protection IP55 classe F
- ◆ Boîtier de pompe avec revêtement anti-corrosif
- ◆ Roue en acier inoxydable 304 ou en fonte
- ◆ Orifice d'aspiration et de refoulement en filetage G20
- ◆ Roulement NSK qualité, joint mécanique de résistance à l'usure

APPLICATIONS/APLICACIONES/APPLICATIONS

- ◆ Suitable for use with liquids that are not chemically aggressive towards the materials from which the pump is made. The self-priming centrifugal pumps are recommended for use in water supply systems, washing systems, pressure systems, irrigation pumps, liquids transfer.
- ◆ Adecuado para usar con líquidos que no son químicamente agresivos con los materiales de los que está hecha la bomba. Las bombas centrífugas autocebantes se recomiendan para su uso en sistemas de suministro de agua, sistemas de lavado, sistemas de presión, bombas de riego, transferencia de líquidos.
- ◆ Convient pour une utilisation avec des liquides qui ne sont pas chimiquement agressifs envers les matériaux à partir desquels la pompe est fabriquée. Les pompes centrifuges auto-amorçantes sont recommandées pour une utilisation dans les systèmes d'alimentation en eau, les systèmes de lavage, les systèmes de pression, les pompes d'irrigation, le transfert de liquides.

USING LIMITS/LÍMITES UTILIZACIÓN/UTILISATION LIMITES

- ◆ Liquid temperature between **-10°C** and **+120°C**
- ◆ Ambient temperature up to **+50°C**
- ◆ Max. working pressure **16 bar**
- ◆ Continuous service **S1**
- ◆ Temperatura del líquido de **-10 °C** hasta **+120 °C**
- ◆ Temperatura ambiente hasta **+50 °C**
- ◆ Presión máxima en el cuerpo de la bomba **16 bar**
- ◆ Funcionamiento continuo **S1**
- ◆ Température du liquide entre **-10 °C** et **+120 °C**
- ◆ Température ambiante jusqu'à **+50 °C**
- ◆ Max. pression de service **16 bar**
- ◆ Service continu **S1**

TECHNICAL DATA/DATOS TÉCNICOS/DONNÉES TECHNIQUES

50 Hz n=2900 1/min

MODEL/MODELO/MODELE	Single-phase Monofásico Monophasé	Three-phase Trifásico Triphasé	Power Potencia/Puissance		Max Q	Max H	Rated Q	Rated H	Suction H	RPM	Impeller Impulsor Roue	DN
			kw	hp								
15-30-1.5m	15-30-1.5	1.5	2	15	30	8	23	8	2900	SS304/Inox304/Inox304	40x40	
18-28-1.5m	18-28-1.5	1.5	2	18	28	10	20	8	2900	SS304/Inox304/Inox304	50x50	
18-35-2.2m	18-35-2.2	2.2	3	18	35	10	25	8	2900	SS304/Inox304/Inox304	40x40	
20-32-2.2m	20-32-2.2	2.2	3	20	32	12	22	8	2900	SS304/Inox304/Inox304	50x50	
22-40-3m	22-40-3	3	4	22	40	12	28	8	2900	SS304/Inox304/Inox304	50x50	
-	25-45-4	4	5.5	25	45	15	30	8	2900	SS304/Inox304/Inox304	50x50	
W15-25-1.5m	W15-25-1.5	1.5	2	15	25	10	18	8	2900	Cast iron/Fundición/Fonte	50x50	
W18-30-2.2m	W18-30-2.2	2.2	3	18	30	10	20	8	2900	Cast iron/Fundición/Fonte	50x50	
W25-35-3m	W25-35-3	3	4	25	35	12	22	8	2900	Cast iron/Fundición/Fonte	50x50	
-	W28-38-4	4	5.5	28	38	15	25	8	2900	Cast iron/Fundición/Fonte	50x50	

W=Sewage water available/Agua sucia disponible/Eaux usées disponibles

MATERIAL DESCRIPTION/DESCRIPCIÓN DE MATERIAL/DESCRIPTION DU MATÉRIEL

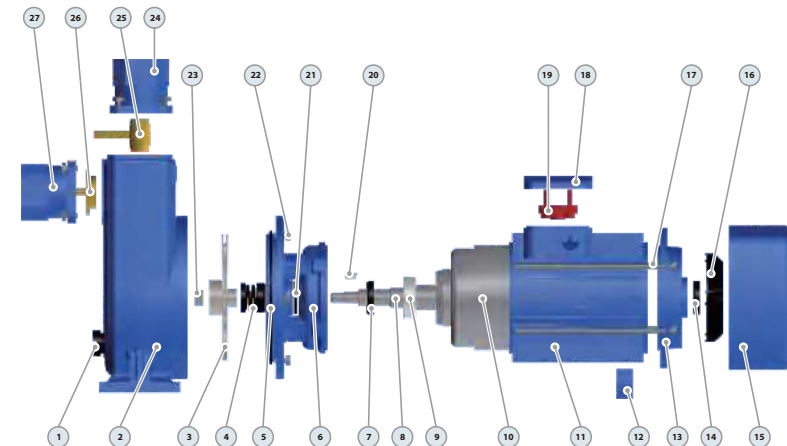

No.	Description Descripción Description	Material Material Matériel	No.	Description Descripción Description	Material Material Matériel	No.	Description Descripción Description	Material Material Matériel
1	Release Valve Tapón Cebado Soupape de décharge	Plastic Plástico Plastique	10	Wound Stator/Rotor Estator/Rotor Stator/Rotor	Silicon Steel/Copper Silicio-Cobre Silicium-Cuivre	19	Terminal Board Tablero Bornas Bornier	Plastic Plástico Plastique
2	Pump Case Cuerpo de Bomba Boîtier de pompe	Cast iron Fundición Fonte	11	Motor Case Cuerpo Motor Boîtier Moteur	Aluminum Aluminium	20	Impeller Key Chaveta Le fer	Iron Hierro Le fer
3	Impeller Impulsor Roue	SS304/Cast iron Inox 304/Fundición Inox 304/Fonte	12	Support Foot Soporte Pie Pied support	Plastic Plástico Plastique	21	Water Deflector Deflector Déflecteur	Rubber Caucho Caoutchouc
4	Mechanical Seal Cierre Mecánico Sceller	SiC/Carbon/SS304 SiC/Grafito/Inox304 SiC/Carbon/Inox304	13	Back Cover Tapa Trasera Capot Arrière	Cast iron Fundición Fonte	22	Connection Bolt Perno Boulon de connexion	Steel Acero Acier
5	O-ring Junta Toriánica Joint torique	Rubber Caucho Caoutchouc	14	Reinforced Seal Sello Reforzado Sceller	Rubber Caucho Caoutchouc	23	Impeller Nut Nuez Noix	Galvanized Steel Acero Galvanizado Acier Galvanisé
6	Connection Conexión	Cast iron Fundición Fonte	15	Fan Cover Tapa Capot	Aluminum Aluminium	24	Discharge Descarga Décharge	Cast iron Fundición Fonte
7	Reinforced Seal Sello Reforzado Sceller	Rubber Caucho Caoutchouc	16	Fan Ventilador Ventilateur	Plastic Plástico Plastique	25	Ball Valve Válvula Bola Vanne à bille	Brass Bronce Laiton
8	Shaft Eje Arbre	SS304-45# Steel Inox 304-Hierro Inox 304-Acier	17	Through Bolt Perno Acier	Steel Acero Acier	26	Check Valve Válvula Retención Clapet anti-retour	Brass Bronce Laiton
9	Bearing Rodamiento Palier	Ball Bearing Bola Rodamiento Palier/Balle	18	Terminal Box Caja Bornas Boîte Bornes	Aluminum Aluminium	27	Suction Succión Suction	Cast iron Fundición Fonte



PZW

Self-priming non-blocking sewage pump
 Bomba de aguas residuales autocebante
 Pompe d'égout autobloquante non bloquante



NEW/NUEVO/NOUVEAU

DESCRIPTION/DESCRIPCIONES/DESCRIPTION

- ◆ Self-priming non-blocking sewage pump design
- ◆ Impeller in two vanes, non-clogging, close but big fluid channels
- ◆ Bare shaft pump separate or coupled with motor both available
- ◆ Stainless steel 304 all wetted parts available for all models
- ◆ High efficiency thanks to the excellent hydraulic model is adopted
- ◆ Strong drainage capacity with non-blocking design
- ◆ Good self-priming performance 4.5-6.0m
- ◆ Diseño de bomba de aguas residuales sin bloqueo autocebante
- ◆ Impulsor en dos paletas, sin obstrucción, tipo de canales grande
- ◆ Bomba de eje desnudo separada o acoplada con motor
- ◆ Inox 304 todas las partes húmedas disponibles para todos los modelos
- ◆ Alta eficiencia gracias al excelente modelo hidráulico adoptado
- ◆ Fuerte capacidad de drenaje con diseño sin bloqueo
- ◆ Buen rendimiento de autocebado 4.5-6.0m
- ◆ Conception de pompe d'égout autobloquante non bloquante
- ◆ Roue à deux aubes, non obstruante, type à canaux gros
- ◆ Pompe à arbre nu séparée ou couplée au moteur disponible
- ◆ Inox304 toutes les pièces mouillées disponibles pour tous les modèles
- ◆ D'un rendement élevé grâce à l'excellent modèle hydraulique
- ◆ Forte capacité de drainage avec une conception non bloquante
- ◆ Bonne performance d'auto-amorçage 4.5-6.0 m

APPLICATIONS/APLICACIONES/APPLICATIONS

A liquid storage chamber is provided in the pump body, suitable for chemical, petroleum, pharmaceutical, mining, papermaking, fiber, pulp, textile, food, power plant and municipal sewage works, public facilities sewage, river pond breeding and other industries.

Se proporciona una cámara de almacenamiento de líquidos en el cuerpo de la bomba, adecuada para químicos, petróleo, farmacéuticos, minería, fabricación de papel, fibra, pulpa, textiles, alimentos, plantas de energía y obras de alcantarillado municipal, alcantarillado de instalaciones públicas, cría de estanques de ríos y otras industrias.

Une chambre de stockage de liquide est fournie dans le corps de la pompe, adaptée aux produits chimiques, pétroliers, pharmaceutiques, miniers, papetiers, aux fibres, à la pâte, au textile, à l'alimentation, aux centrales électriques et aux réseaux d'égouts municipaux, aux eaux usées des installations publiques, à l'élevage d'étangs fluviaux et à d'autres industries.

USING LIMITS/LÍMITES UTILIZACIÓN/UTILISATION LIMITES

- ◆ Liquid temperature between -10°C and +80°C
- ◆ Ambient temperature between -10°C and +50°C
- ◆ PH 6-9 for cast iron, 2-13 for stainless steel
- ◆ Media weight not exceed 1240 kg / m³
- ◆ Temperatura del líquido entre -10°C y +80°C
- ◆ Temperatura ambiente entre -10°C y +50°C
- ◆ PH 6-9 para hierro fundido, 2-13 para acero inoxidable
- ◆ El peso del medio no excede 1240 kg / m³
- ◆ Température du liquide entre -10°C et +80°C
- ◆ Température ambiante entre -10°C et +50°C
- ◆ PH 6-9 pour la fonte, 2-13 pour l'acier inoxydable
- ◆ Le poids du support ne dépasse pas 1240 kg / m³

TECHNICAL DATA/DATOS TÉCNICOS/DONNÉES TECHNIQUES

MODEL MODELO MODÈLE	Power Potencia Puissance		DN mm	Flow Caudal Débit m ³ /h	Head Altura Hauteur m	RPM	Pump/Bomba/Pompe DIM.(mm)		
	kW	hp					L	W	H
PZW25-8-15/2	1.5	2	25x25	8	15	2900	440	280	470
PZW32-5-20/2	2.2	3	32x32	5	20	2900	440	280	470
PZW32-9-30/2	3	4	32x32	9	30	2900	480	310	530
PZW40-10-20/2	2.2	3	40x40	10	20	2900	440	280	470
PZW40-15-30/2	3	4	40x40	15	30	2900	480	310	530
PZW50-10-20/2	2.2	3	50x50	10	20	2900	440	280	470
PZW50-20-15/2	2.2	3	50x50	20	15	2900	440	280	470
PZW50-18-22/2	3	4	50x50	18	22	2900	480	310	530
PZW50-15-30/2	3	4	50x50	15	30	2900	480	310	530
PZW50-20-35/2	5.5	7.5	50x50	20	35	2900	680	350	630
PZW50-20-40/2	7.5	10	50x50	20	40	2900	660	330	640
PZW50-20-50/2	11	15	50x50	20	50	2900	680	420	650
PZW65-30-18/2	4	5.5	65x65	30	18	2900	500	330	530
PZW65-30-18/4	4	5.5	65x65	30	18	1450	680	340	680
PZW65-25-30/2	5.5	7.5	65x65	25	30	2900	660	330	640
PZW65-25-40/2	7.5	10	65x65	25	40	2900	660	330	640
PZW65-25-50/2	11	15	65x65	25	50	2900	680	420	650
PZW65-40-25/2	7.5	10	65x65	40	25	2900	660	330	640
PZW80-40-16/4	4	5.5	80x80	40	16	2900	500	330	530
PZW80-40-16/4	4	5.5	80x80	40	16	1450	680	340	680
PZW80-25-40/2	7.5	10	80x80	25	40	2900	660	330	640
PZW80-50-15/2	5.5	7.5	80x80	50	15	2900	590	335	590
PZW80-65-25/2	7.5	10	80x80	65	25	2900	590	335	590
PZW80-50-30/2	11	15	80x80	50	30	2900	680	340	680
PZW80-80-35/2	15	20	80x80	80	35	2900	750	450	730
PZW80-50-60/2	22	30	80x80	50	60	2900	720	430	700

MODEL CODE/CÓDIGO MODELO/CODE MODÈLE

For example/ Por ejemplo/ Par exemple

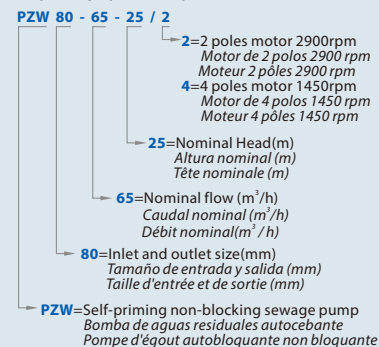

50 Hz n=2900/1450 1/min

MODEL MODELO MODÈLE	Power Potencia Puissance		DN mm	Flow Caudal Débit m ³ /h	Head Altura Hauteur m	RPM	Pump/Bomba/Pompe DIM.(mm)		
	kW	hp					L	W	H
PZW100-100-10/4	5.5	7.5	100x100	100	10	1450	790	425	800
PZW100-80-20/4	7.5	10	100x100	80	20	1450	790	425	800
PZW100-100-15/4	7.5	10	100x100	100	15	1450	790	425	800
PZW100-100-15/2	11	15	100x100	100	15	2900	790	425	800
PZW100-100-20/2	15	20	100x100	100	20	2900	860	450	820
PZW100-100-20/4	11	15	100x100	100	20	1450	810	450	880
PZW100-100-30/2	22	30	100x100	100	30	2900	860	450	820
PZW100-80-45/2	30	40	100x100	80	45	2900	825	550	840
PZW100-80-60/2	37	50	100x100	80	60	2900	825	550	840
PZW100-80-80/2	45	60	100x100	80	80	2900	825	550	840
PZW125-120-20/4	15	20	125x125	120	20	1450	810	450	880
PZW150-180-10/4	11	15	150x150	180	10	1450	810	450	880
PZW150-180-14/4	15	20	150x150	180	14	1450	810	450	880
PZW150-180-20/4	18.5	25	150x150	180	20	1450	810	450	880
PZW150-180-30/4	30	40	150x150	180	30	1450	870	550	990
PZW150-180-35/4	37	50	150x150	180	35	1450	950	650	1065
PZW150-180-38/4	45	60	150x150	180	38	1450	1020	580	930
PZW150-180-45/4	55	75	150x150	180	45	1450	950	650	1065
PZW200-280-14/4	22	30	200x200	280	14	1450	1040	510	1020
PZW200-280-20/4	37	50	200x200	280	20	1450	1040	560	1020
PZW200-280-25/4	45	60	200x200	280	25	1450	1040	560	1020
PZW200-280-28/4	55	75	200x200	280	28	1450	1230	520	1030
PZW250-420-14/4	45	60	250x250	420	14	1450	1060	680	1100
PZW250-420-20/4	55	75	250x250	420	20	1450	1060	680	1100
PZW300-800-14/4	55	75	300x300	800	14	1450	1500	680	1350
PZW300-800-20/4	75	100	300x300	800	20	1450	1500	680	1350

TECHNICAL SHEET/HOJA TÉCNICA/FICHE TECHNIQUE

Model/Modelo/Modèle	PZW	
Capacity/Caudal/Débit	0-800	m ³ /h
Head/Altura/Hauteur	0-80	m
DN	25-300	mm
Speed/Velocidad/Vitesse	2900/1450	rpm
T max	80	°C
Power/Potencia/Puiss.	1.5-75	kW
Voltage/Voltaje/Tension	220/380/400/440	V
HZ	50	
Class/Clase/Classe	Class F	
IP	IP 55	
Duty/Servicio/Devoir	S1 continuous	

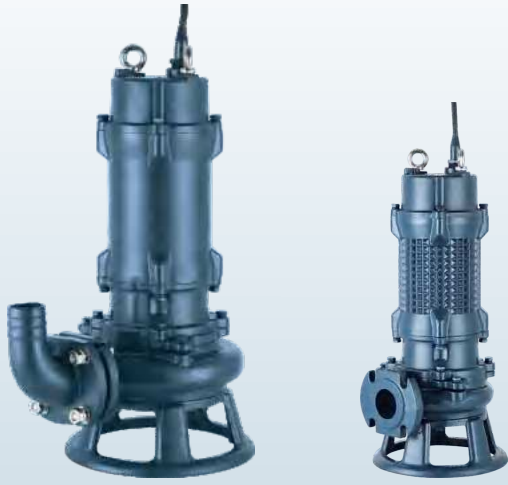

WQV

Vortex cutting submersible pump
 Vórtice bomba sumergible de corte
 Pompe submersible de coupe Vortex



NEW/NUEVO/NOUVEAU

DESCRIPTION/DESCRIPCIONES/DESCRIPTION

- ◆ New cutting submersible sewage pumps design
 - ◆ Equipped with vortex alloy impeller with 48HR(hardness)
 - ◆ Better hydraulic characteristics
 - ◆ Pump case in heavy gauge robust cast iron HT250
 - ◆ Casing resistant to abrasion and long-lasting
 - ◆ Discharge port with bolts, nuts and gaskets
 - ◆ Quality NSK bearing, wear resistance mechanical seal
- ◆ Nuevo diseño de bombas sumergibles corte para aguas residuales
 - ◆ Equipado con impulsor de aleación vortex con 48HR (dureza)
 - ◆ Mejores características hidráulicas
 - ◆ Caja de bomba en hierro fundido robusto de gran calibre HT250
 - ◆ Carcasa resistente a la abrasión y duradera.
 - ◆ Puerto de descarga con pernos, tuercas y empalmes
 - ◆ Rodamiento de marca NSK y cierre mecánico personalizado
- ◆ Nouvelle conception de pompes submersibles coupe pour eaux usées
 - ◆ Équipé d'une roue en alliage vortex avec 48HR (dureté)
 - ◆ Meilleures caractéristiques hydrauliques
 - ◆ Carter de pompe en fonte robuste de fort calibre HT250
 - ◆ Boîtier résistant à l'abrasion et durable
 - ◆ Orifice de décharge avec boulons, écrous et joints
 - ◆ Roulement NSK qualité, joint mécanique de résistance à l'usure

USING LIMITS/LÍMITES UTILIZACIÓN/UTILISATION LIMITES



MODEL CODE/CÓDIGO MODELO/CODE MODÈLE

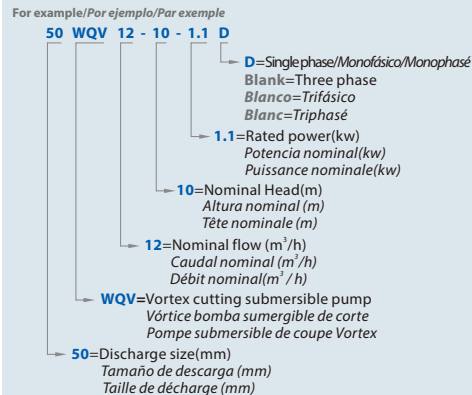

TECHNICAL DATA/DATOS TÉCNICOS/DONNÉES TECHNIQUES

50 Hz n=2900/1450 1/min

MODEL/MODELO/MODÈLE		Power Potencia/Puissance		Rated Q	Rated H	RPM	DN	KGS	DIM
Single-phase Monofásico/Monophasé	Three-phase Trifásico/Triphasé	hp	kw	m ³ /h	m		mm		cm
40WQV10-10-0.75D	40WQV10-10-0.75	1	0.75	10	10	2900	40	22.5	48*20*22
40WQV12-10-1.1D	40WQV12-10-1.1	1.5	1.1	12	10	2900	40	23.7	48*20*22
50WQV10-10-0.75D	50WQV10-10-0.75	1	0.75	10	10	2900	50	22.5	48*20*22
50WQV12-10-1.1D	50WQV12-10-1.1	1.5	1.1	12	10	2900	50	23.7	48*20*22
50WQV15-15-1.5D	50WQV15-15-1.5	2	1.5	15	15	2900	50	36.5	60*27*25
-	50WQV9-22-2.2	3	2.2	9	22	2900	50	40.1	61*29*29
-	65WQV25-15-2.2	3	2.2	25	15	2900	65	41.4	61*29*29
-	80WQV45-9-2.2	3	2.2	45	9	2900	80	43.4	61*29*29
-	50WQV20-22-3	4	3	20	22	2900	50	45.8	63*26*30
-	65WQV35-15-3	4	3	35	15	2900	65	46.6	63*26*30
-	80WQV43-13-3	4	3	43	13	2900	80	47.4	63*26*30
-	65WQV25-22-4	5.5	4	25	22	2900	65	52.2	64*29*32
-	80WQV45-17-4	5.5	4	45	17	2900	80	52.9	64*29*32
-	80WQV30-25-4	5.5	4	30	25	2900	80	53.5	64*29*32
-	80WQV45-20-5.5	7.5	5.5	45	20	2900	80	62.5	73*29*34
-	100WQV65-15-5.5	7.5	5.5	65	15	2900	100	63.6	73*29*34
-	80WQV45-22-7.5	10	7.5	45	22	2900	80	72	73*31*35
-	100WQV100-13-7.5	10	7.5	100	13	2900	100	73.5	73*31*35
-	100WQV80-25-11	15	11	80	25	1450	100	187	96*53*44
-	150WQV150-15-11	15	11	150	15	1450	150	201	101*52*42
-	100WQV80-30-15	20	15	80	30	1450	100	208	100*53*44
-	150WQV200-15-15	20	15	200	15	1450	150	222	105*52*42
-	150WQV250-15-18.5	25	18.5	250	15	1450	150	286	115*57*44
-	200WQV350-12-18.5	25	18.5	350	12	1450	200	294	120*58*46
-	150WQV300-15-22	30	22	300	15	1450	150	307	125*57*44
-	200WQV400-10-22	30	22	400	10	1450	200	324	120*58*46
-	200WQV350-15-30	40	30	350	15	1450	200	440	135*57*67
-	250WQV600-10-30	40	30	600	10	1450	250	440	140*60*67

IMPELLER TYPE/TIPO DE IMPULSOR/TYPE ROUE

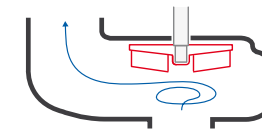

VORTEX

MATERIAL DESCRIPTION/DESCRIPCIÓN DE MATERIAL/DESCRIPTION DU MATÉRIEL

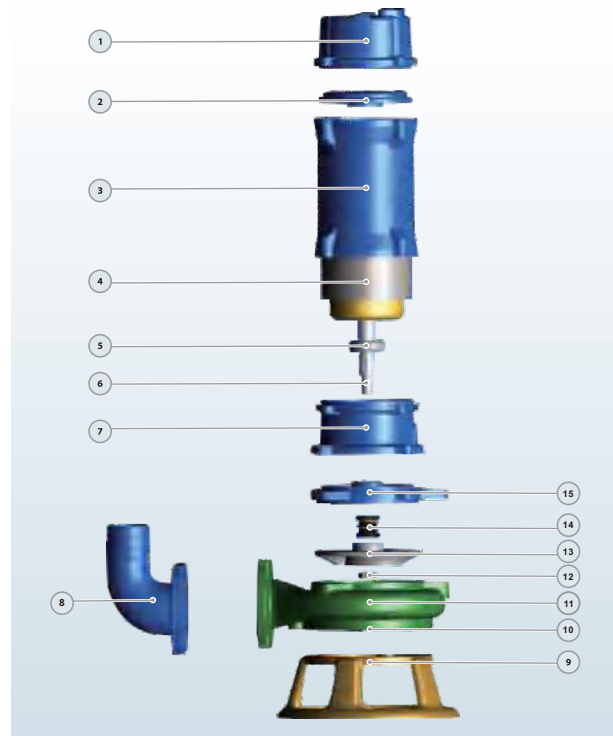

No.	Description Descripción Description	Material Material Matériel
1	Motor cover Tapa de motor Capot moteur	Cast iron Fundición Fonte
2	Plate Plato Assiette	Cast iron Fundición Fonte
3	Motor Case Cuerpo de Motor Boîtier du moteur	Cast iron Fundición Fonte
4	Wound Stator/Rotor Estator/Rotor Stator/Rotor de blessure	Silicon Steel/Copper Silicio-Cobre Silicium-Cuivre
5	Bearing Rodamiento Palier	Ball Bearing Bola Rodamiento Palier Balle
6	Shaft Eje Arbre	SS304-45# Steel Inox 304-Hierro Inox304-Acier
7	Chamber Sala Chambre	Cast iron Fundición Fonte
8	Output flange Brida de salida Bride de sortie	Cast iron Fundición Fonte
9	Base Base Base	Cast iron Fundición Fonte
10	Cutter plate Placa de corte Plaque de coupe	Alloy 48HR Aleación 48HR Alliage 48HR
11	Pump Case Cuerpo de Bomba Boîtier de pompe	Cast iron Fundición Fonte
12	Impeller Nut Nuez Noix	Galvanized Steel Acero Galvanizado Acier Galvanisé
13	Impeller Impulsor Roue	Alloy 48HR Aleación 48HR Alliage 48HR
14	Mechanical Seal Cierre Mecánico Sceller	SiC/Carbon/SS304 SiC/Grafito/Inox304 SiC/Carbon/Inox304
15	Seal plate Plato sello Plaque d'étanchéité	Cast iron Fundición Fonte

PERFORMANCE CURVE/CURVA DE RENDIMIENTO/COURBE DE PERFORMANCE

50 Hz n=2900 1/min

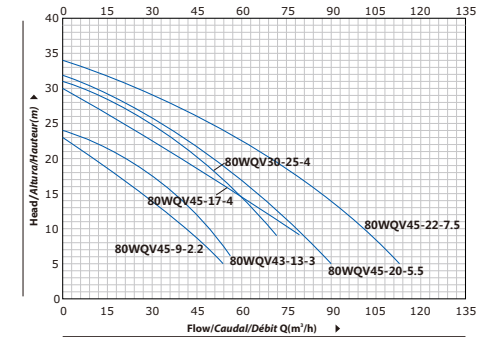
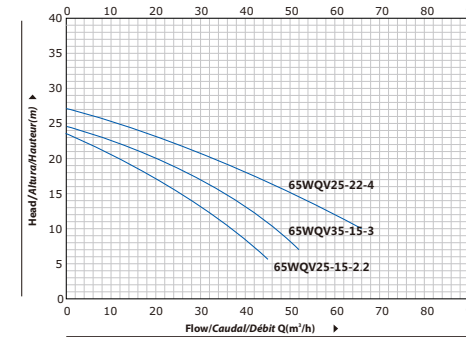

50 Hz n=2900/1450 1/min

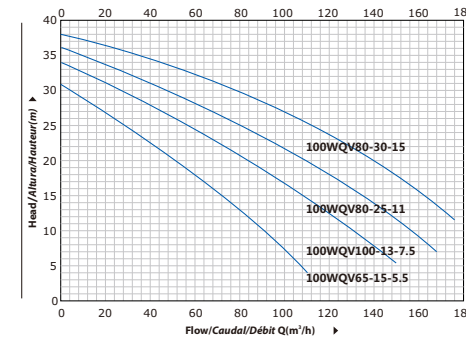

50 Hz n=1450 1/min

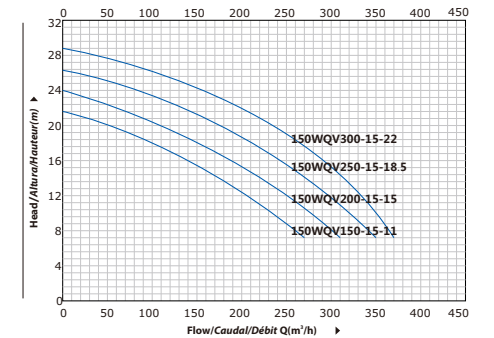

PERFORMANCE CURVE/CURVA DE RENDIMIENTO/COURBE DE PERFORMANCE

50 Hz n=2900 1/min

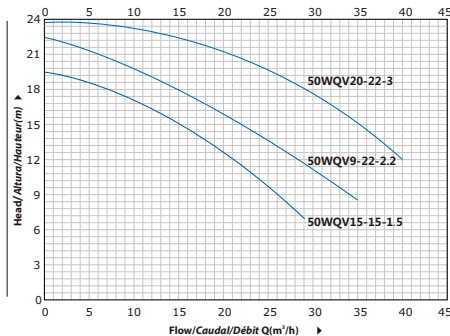
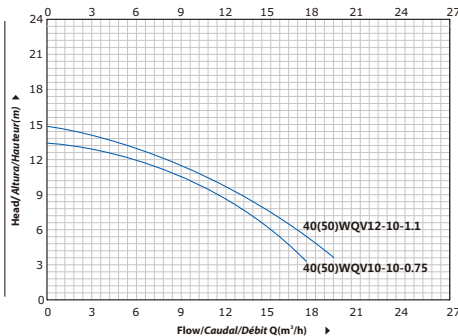

50 Hz n=1450 1/min

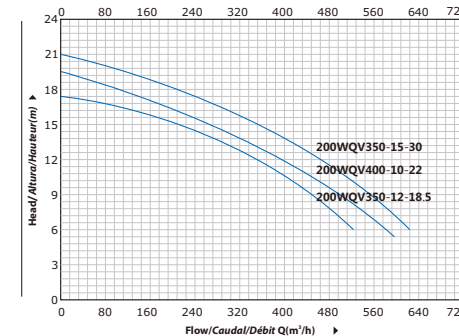

50 Hz n=1450 1/min

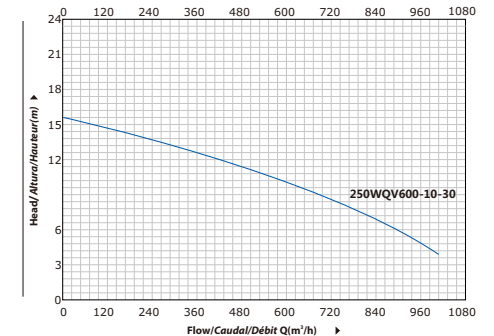



WQ

Submersible sewage pump
Bomba sumergible para aguas sucias
Pompe submersible pour eaux usées

NEW/NUEVO/NOUVEAU

DESCRIPTION/DESCRIPCIONES/DESCRIPTION

- ◆ Complete range with a full series submersible sewage pumps
 - ◆ Better hydraulic characteristics
 - ◆ Pump case in heavy gauge robust cast iron HT250
 - ◆ Casing resistant to abrasion and long-lasting
 - ◆ YE3 high efficient motor, with protection IP68 class F
 - ◆ Impeller in two vanes, non-clogging, close but big fluid channels
 - ◆ Discharge port with bolts, nuts and gaskets
- ◆ Gama completa con una serie completa de bombas para aguas residuales
 - ◆ Mejores características hidráulicas
 - ◆ Caja de bomba en hierro fundido robusto de gran calibre HT250
 - ◆ Carcasa resistente a la abrasión y duradera.
 - ◆ Motor de alta eficiencia YE3, con protección IP68 clase F
 - ◆ Impulsor en dos paletas, sin obstrucción, tipo de canales grande
 - ◆ Puerto de descarga con pernos, tuercas y empalmes
- ◆ Gamme complète avec une série complète de pompes pour eaux usées
 - ◆ Meilleures caractéristiques hydrauliques
 - ◆ Carter de pompe en fonte robuste de fort calibre HT250
 - ◆ Boîtier résistant à l'abrasion et durable
 - ◆ Moteur haute efficacité YE3, avec protection IP68 classe F
 - ◆ Roue à deux aubes, non obstruante, type à canaux étroits mais gros
 - ◆ Orifice de décharge avec boulons, écrous et joints

USING LIMITS/LÍMITES UTILIZACIÓN/UTILISATION LIMITES

- ◆ Temperature of the liquid to +40 °C
 - ◆ **10m** maximum immersion depth
 - ◆ Solids passage: from **25mm** to **75mm**
- ◆ Temperatura del líquido a +40 °C
 - ◆ **10m** de profundidad de inmersión máxima
 - ◆ Paso de sólidos: de **25 mm** a **75 mm**
- ◆ Température du liquide à +40 °C
 - ◆ Profondeur d'immersion maximale de **10m**
 - ◆ Passage des solides: de **25 mm** à **75 mm**

MODEL CODE/CÓDIGO MODELO/CODE MODÈLE

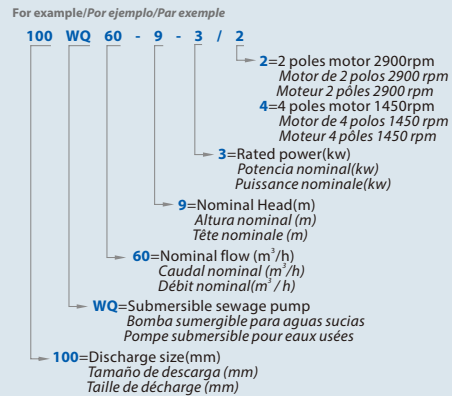

TECHNICAL DATA/DATOS TÉCNICOS/DONNÉES TECHNIQUES

MODEL MODELO MODÈLE	DN mm			Power Potencia Puissance kw	RPM
		m ³ /h	m		
50WQ10-10-0.75/2	50	10	10	0.75	2900
50WQ7-15-1.1/2	50	7	15	1.1	2900
25WQ5-22-1.1/2	25	5	22	1.1	2900
32WQ6-20-1.1/2	32	6	20	1.1	2900
40WQ7-18-1.1/2	40	7	18	1.1	2900
50WQ10-12-1.1/2	50	10	12	1.1	2900
65WQ15-9-1.1/2	65	15	9	1.1	2900
40WQ8-18-1.5/2	40	8	18	1.5	2900
50WQ10-16-1.5/2	50	10	16	1.5	2900
50WQ15-15-1.5/2	50	15	15	1.5	2900
65WQ20-10-1.5/2	65	20	10	1.5	2900
80WQ40-7-1.5/2	80	40	7	1.5	2900
100WQ50-5-1.5/2	100	50	5	1.5	2900
40WQ8-24-2.2/2	40	8	24	2.2	2900
50WQ9-22-2.2/2	50	9	22	2.2	2900
50WQ15-20-2.2/2	50	15	20	2.2	2900
65WQ20-15-2.2/2	65	20	15	2.2	2900
80WQ40-10-2.2/2	80	40	10	2.2	2900
100WQ50-7-2.2/2	100	50	7	2.2	2900
50WQ15-25-3/2	50	15	25	3	2900
65WQ25-18-3/2	65	25	18	3	2900
65WQ37-13-3/2	65	37	13	3	2900
80WQ45-12-3/2	80	45	12	3	2900
80WQ43-13-3/2	80	43	13	3	2900
100WQ60-9-3/2	100	60	9	3	2900
50WQ15-30-4/2	50	15	30	4	2900
65WQ25-25-4/2	65	25	25	4	2900
80WQ40-16-4/2	80	40	16	4	2900
100WQ60-12-4/2	100	60	12	4	2900
100WQ80-10-4/2	100	80	10	4	2900
50WQ20-35-5.5/2	50	20	35	5.5	2900
65WQ25-30-5.5/2	65	25	30	5.5	2900
80WQ40-22-5.5/2	80	40	22	5.5	2900
100WQ60-18-5.5/2	100	60	18	5.5	2900
150WQ120-8-5.5/2	150	120	8	5.5	2900
50WQ20-42-7.5/2	50	20	42	7.5	2900
65WQ25-36-7.5/2	65	25	36	7.5	2900
80WQ40-28-7.5/2	80	40	28	7.5	2900
100WQ65-22-7.5/2	100	65	22	7.5	2900
150WQ100-10-7.5/2	150	100	10	7.5	2900
50WQ20-55-11/2	50	20	55	11	2900
65WQ30-40-11/2	65	30	40	11	2900
80WQ60-30-11/2	80	60	30	11	2900

MODEL MODELO MODÈLE	DN mm			Power Potencia Puissance kw	RPM
		m ³ /h	m		
100WQ80-25-11/2	100	80	25	11	2900
150WQ100-20-11/2	150	100	20	11	2900
150WQ120-15-11/2	150	120	15	11	2900
200WQ180-11-11/2	200	180	11	11	2900
50WQ20-70-15/2	50	20	70	15	2900
65WQ30-60-15/2	65	30	60	15	2900
80WQ60-40-15/2	80	60	40	15	2900
100WQ80-35-15/2	100	80	35	15	2900
150WQ100-30-15/2	150	100	30	15	2900
150WQ120-25-15/2	150	120	25	15	2900
200WQ180-15-15/2	200	180	15	15	2900
50WQ20-80-18.5/2	50	20	80	18.5	2900
65WQ30-68-18.5/2	65	30	68	18.5	2900
80WQ60-45-18.5/2	80	60	45	18.5	2900
100WQ80-40-18.5/2	100	80	40	18.5	2900
150WQ100-36-18.5/2	150	100	36	18.5	2900
200WQ180-18-18.5/2	200	180	18	18.5	2900
50WQ20-90-22/2	50	20	90	22	2900
65WQ30-75-22/2	65	30	75	22	2900
80WQ60-50-22/2	80	60	50	22	2900
100WQ80-45-22/2	100	80	45	22	2900
150WQ100-40-22/2	150	100	40	22	2900
200WQ200-20-22/2	200	200	20	22	2900
80WQ80-13-5.5/4	80	80	13	5.5	1450
100WQ110-10-5.5/4	100	110	10	5.5	1450
150WQ150-7-5.5/4	150	150	7	5.5	1450
80WQ80-20-7.5/4	80	80	20	7.5	1450
100WQ100-15-7.5/4	100	100	15	7.5	1450
150WQ145-9-7.5/4	150	145	9	7.5	1450
200WQ250-6-7.5/4	200	250	6	7.5	1450
100WQ100-25-11/4	100	100	25	11	1450
150WQ180-11-11/4	150	180	11	11	1450
200WQ300-7-11/4	200	300	7	11	1450
250WQ400-5-11/4	250	400	5	11	1450
100WQ100-30-15/4	100	100	30	15	1450
150WQ200-15-15/4	150	200	15	15	1450
200WQ250-11-15/4	200	250	11	15	1450
250WQ500-5-15/4	250	500	5	15	1450
100WQ100-35-18.5/4	100	100	35	18.5	1450
150WQ180-20-18.5/4	150	180	20	18.5	1450
200WQ250-15-18.5/4	200	250	15	18.5	1450
200WQ350-10-18.5/4	200	350	10	18.5	1450
250WQ500-7-18.5/4	250	500	7	18.5	1450

TECHNICAL DATA/DATOS TÉCNICOS/DONNÉES TECHNIQUES

MODEL MODELO MODÈLE	DN	Flow Caudal Débit	Head Altura Hauteur	Power Potencia Puissance	RPM
	mm	m ³ /h	m	kw	
300WQ650-5-18.5/4	300	650	5	18.5	1450
100WQ100-40-22/4	100	100	40	22	1450
150WQ200-22-22/4	150	200	22	22	1450
200WQ300-16-22/4	200	300	16	22	1450
200WQ400-10-22/4	200	400	10	22	1450
250WQ500-9-22/4	250	500	9	22	1450
300WQ650-7-22/4	300	650	7	22	1450
100WQ120-45-30/4	100	120	45	30	1450
150WQ180-30-30/4	150	180	30	30	1450
200WQ250-22-30/4	200	250	22	30	1450
250WQ500-12-30/4	250	500	12	30	1450
250WQ600-9-30/4	250	600	9	30	1450
300WQ800-7-30/4	300	800	7	30	1450
300WQ1000-6-30/6	300	1000	6	30	980
350WQ1500-4-30/6	350	1500	4	30	980
100WQ120-50-37/4	100	120	50	37	1450
150WQ200-35-37/4	150	200	35	37	1450
200WQ300-28-37/4	200	300	28	37	1450
200WQ350-25-37/4	200	350	25	37	1450
250WQ600-12-37/4	250	600	12	37	1450
300WQ800-9-37/4	300	800	9	37	1450
350WQ1000-6-37/4	350	1000	6	37	1450
350WQ1100-6-37/6	350	1100	6	37	980
100WQ100-57-45/4	100	100	57	45	1450
150WQ200-40-45/4	150	200	40	45	1450
200WQ300-32-45/4	200	300	32	45	1450
200WQ400-25-45/4	200	400	25	45	1450
250WQ600-15-45/4	250	600	15	45	1450
300WQ800-12-45/4	300	800	12	45	1450
350WQ1200-8-45/4	350	1200	8	45	1450
350WQ1300-8-45/6	350	1300	8	45	980
100WQ100-65-55/4	100	100	65	55	1450
150WQ180-50-55/4	150	180	50	55	1450
200WQ300-40-55/4	200	300	40	55	1450
200WQ400-30-55/4	200	400	30	55	1450
250WQ600-20-55/4	250	600	20	55	1450
300WQ800-15-55/4	300	800	15	55	1450
350WQ1000-10-55/4	350	1000	10	55	1450
350WQ1100-10-55/6	350	1100	10	55	980
100WQ120-75-75/4	100	120	75	75	1450
150WQ200-60-75/4	150	200	60	75	1450
200WQ350-45-75/4	200	350	45	75	1450
250WQ600-25-75/4	250	600	25	75	1450

MODEL MODELO MODÈLE	DN	Flow Caudal Débit	Head Altura Hauteur	Power Potencia Puissance	RPM
	mm	m ³ /h	m	kw	
300WQ800-20-75/4	300	800	20	75	1450
350WQ1000-15-75/4	350	1000	15	75	1450
350WQ1500-12-75/6	350	1500	12	75	980
100WQ120-85-90/4	100	120	85	90	1450
150WQ200-70-90/4	150	200	70	90	1450
200WQ300-60-90/4	200	300	60	90	1450
200WQ400-50-90/4	200	400	50	90	1450
250WQ600-30-90/4	250	600	30	90	1450
300WQ800-25-90/4	300	800	25	90	1450
350WQ1000-18-90/4	350	1000	18	90	1450
350WQ1200-18-90/6	350	1200	18	90	980
100WQ100-100-110/4	100	100	100	110	1450
150WQ180-80-110/4	150	180	80	110	1450
200WQ300-65-110/4	200	300	65	110	1450
250WQ600-40-110/4	250	600	40	110	1450
300WQ1000-25-110/4	300	1000	25	110	1450
350WQ1300-20-110/4	350	1300	20	110	1450
350WQ1600-16-110/6	350	1600	16	110	980
150WQ200-90-132/4	150	200	90	132	1450
200WQ400-75-132/4	200	400	75	132	1450
250WQ600-50-132/4	250	600	50	132	1450
300WQ800-36-132/4	300	800	36	132	1450
350WQ1100-28-132/4	350	1100	28	132	1450
350WQ1500-20-132/6	350	1500	20	132	980
150WQ220-100-160/4	150	220	100	160	1450
200WQ400-85-160/4	200	400	85	160	1450
250WQ600-60-160/4	250	600	60	160	1450
300WQ800-40-160/4	300	800	40	160	1450
350WQ1000-35-160/4	350	1000	35	160	1450
350WQ1200-35-160/6	350	1200	35	160	980
150WQ200-110-185/4	150	200	110	185	1450
200WQ400-90-185/4	200	400	90	185	1450
250WQ600-70-185/4	250	600	70	185	1450
300WQ900-40-185/4	300	900	40	185	1450
350WQ1100-38-185/4	350	1100	38	185	1450
250WQ750-75-200/4	250	750	75	200	1450
300WQ1000-45-200/4	300	1000	45	200	1450
350WQ1300-35-200/4	350	1300	35	200	980
300WQ1100-45-250/4	300	1100	45	250	1450
350WQ1500-36-250/4	350	1500	36	250	1450
300WQ1000-55-315/4	300	1000	55	315	1450
350WQ1500-45-315/4	350	1500	45	315	1450

PERFORMANCE CURVE/CURVA DE RENDIMIENTO/COURBE DE PERFORMANCE

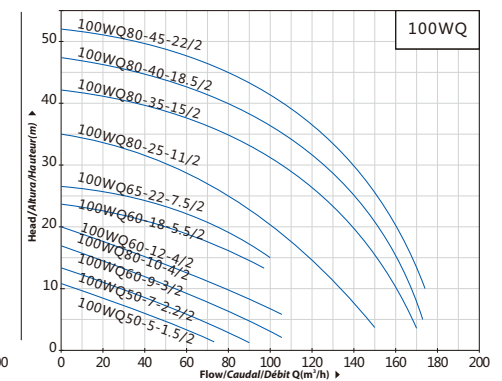
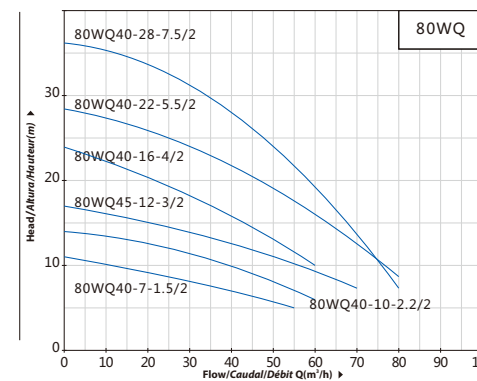
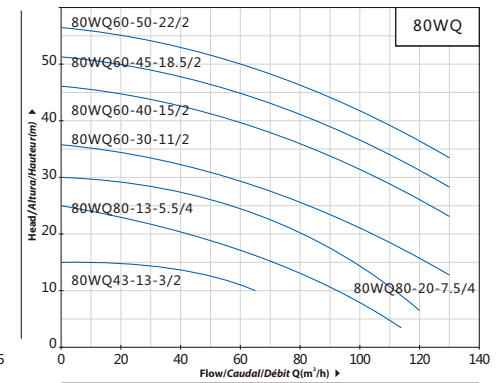
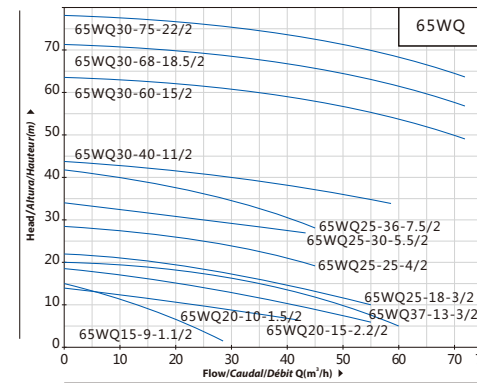
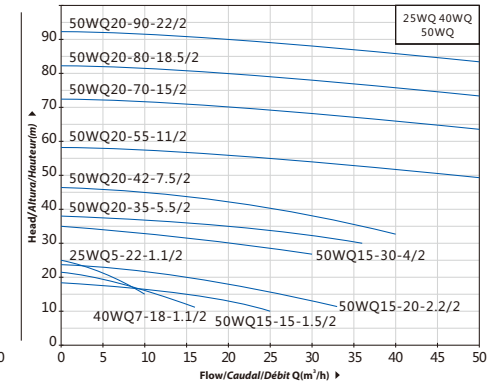
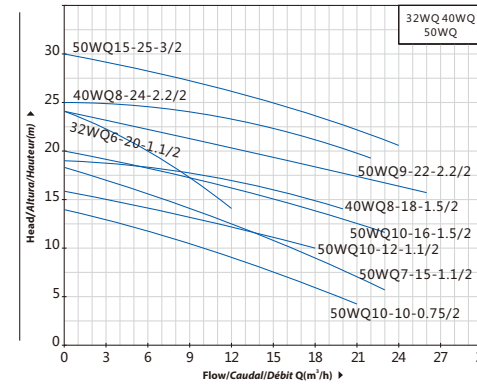

PERFORMANCE CURVE/CURVA DE RENDIMIENTO/COURBE DE PERFORMANCE

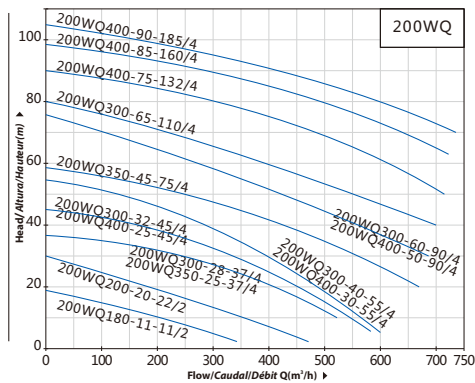
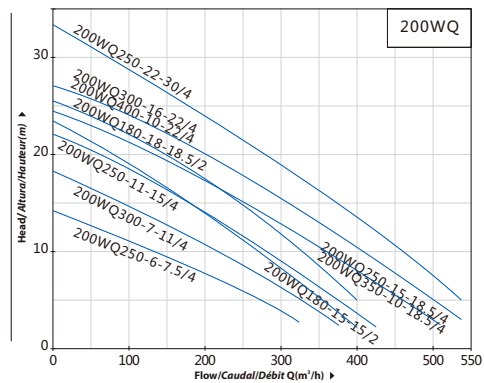
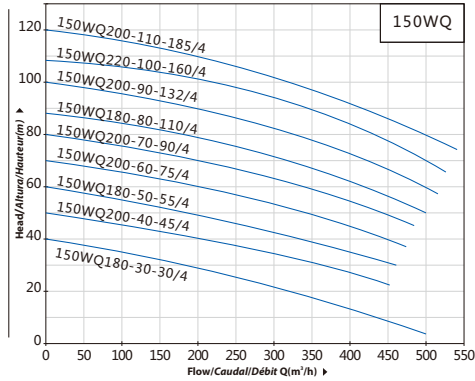
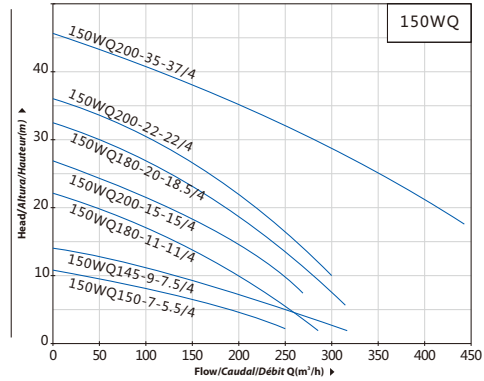
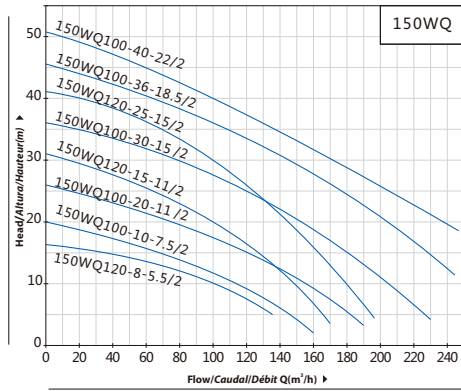
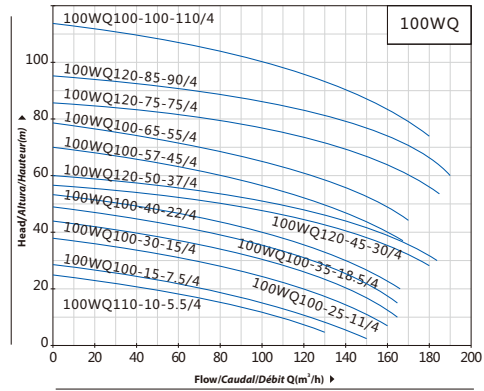

PERFORMANCE CURVE/CURVA DE RENDIMIENTO/COURBE DE PERFORMANCE

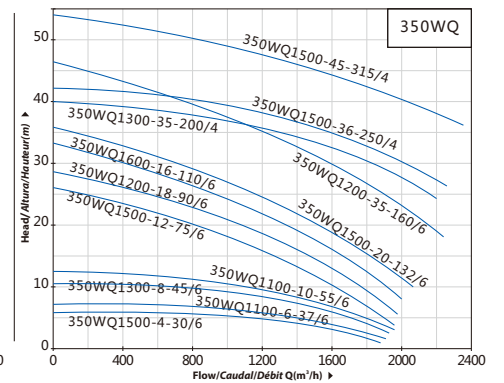
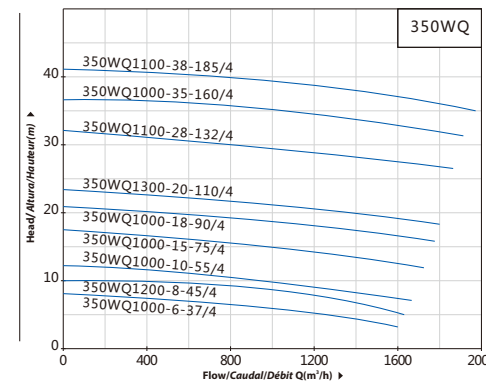
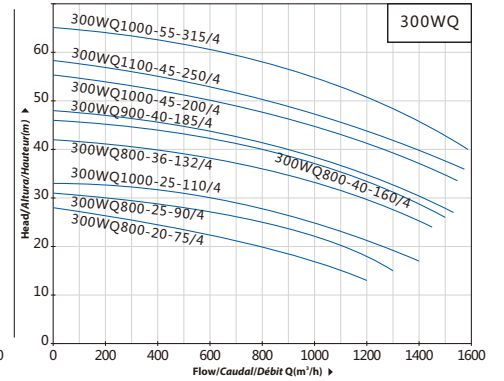
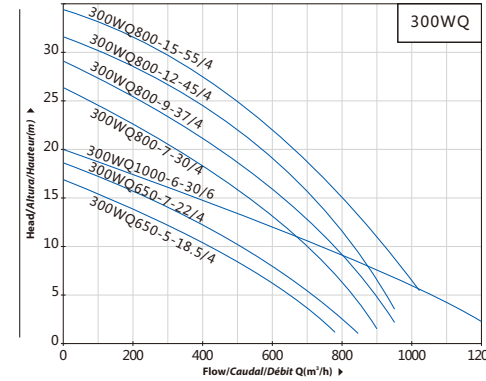
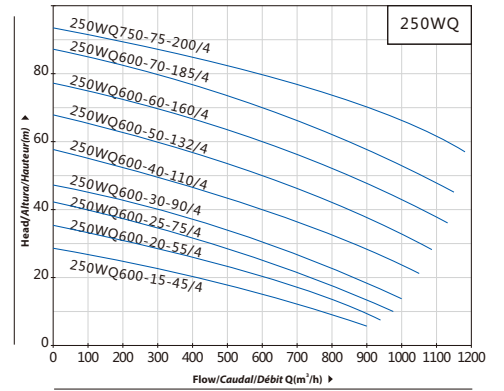
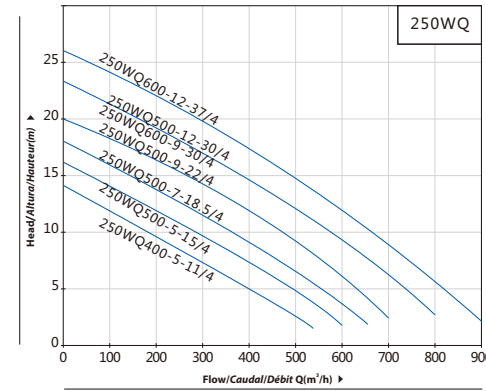



PBWS

Non-negative pressure water supply system
 Sistema de suministro de agua presión no negativa
 Système d'alimentation en eau à pression non négative



NEW/NUEVO/NOUVEAU

DESCRIPTION/DESCRIPCIONES/DESCRIPTION

- A brand-new water supply system
 - Equipped with a water tank of a certain volume
 - Tank made of the stainless steel in food class.
 - Equipped with a water supply quality pump unit
 - The water supply pump unit is independent from the water tank, easy to be maintained and cleaned.
 - Equipped with a negative pressure preventing module
 - Equipped with a multi-function control panel
- Un nuevo sistema de suministro de agua.
 - Equipado con un tanque de agua de un cierto volumen.
 - Tanque hecho del acero inoxidable en la clase de alimentos.
 - Equipado con una unidad bombeo de calidad de suministro de agua.
 - La unidad de bombeo de suministro de agua es independiente de la depósito de agua, fácil de mantener y limpiar.
 - Equipado con un módulo de prevención de presión negativa.
 - Equipado con un panel de control multifunción
- Un tout nouveau système d'alimentation en eau
 - Equipé d'un réservoir d'eau d'un certain volume
 - Réservoir en acier inoxydable dans la classe alimentaire.
 - Equipé d'une pompe de qualité d'alimentation en eau
 - La pompe d'alimentation en eau est indépendante de l'eau réservoir, facile à entretenir et à nettoyer.
 - Equipé d'un module empêchant la pression négative
 - Equipé d'un panneau de commande multifonction

APPLICATIONS/APLICACIONES/APPLICATIONS

- The PBWS series are suitable for those areas with relatively unstable municipal pipe network, long water used peak time and a very strict requirement on the noise, such as hospital, school etc
- La serie PBWS es adecuada para aquellas áreas con redes de tuberías municipales relativamente inestables, horas pico de uso de agua prolongado y un requisito muy estricto sobre el ruido, como hospitales, escuelas, etcétera
- La série PBWS convient aux zones à instabilité relative réseau de canalisations municipales, eau longue utilisée aux heures de pointe et exigence très stricte sur le bruit, comme l'hôpital, l'école, etc.

USING LIMITS/LÍMITES UTILIZACIÓN/UTILISATION LIMITES

- Liquid temperature between -10°C and +120°C
- Ambient temperature between 0°C and +50°C
- Max. working pressure 25 bar/Continuous S1
- Temperatura del líquido de -10 °C hasta +120 °C
- Temperatura ambiente de 0 °C hasta +50 °C
- Presión máxima 25 bar/Continuo S1
- Température du liquide entre -10 °C et +120 °C
- Température ambiante entre 0 °C et +50 °C
- Max. pression de service 25 bar/Continu S1

TECHNICAL DATA/DATOS TÉCNICOS/DONNÉES TECHNIQUES

MODEL MODELO MODÈLE	Flow Caudal Débit	Head Altura Hauteur	Pump Bomba Pompe	Power Potencia Puissance	Tank size	User no.
	m ³ /h	m		kw	ΦxL	
PBWS15/8-2C	8	15	CDL4-2	0.37	Φ600x1.3	25
PBWS24/8-2C	8	24	CDL4-3	0.55	Φ600x1.3	25
PBWS32/8-2C	8	32	CDL4-4	0.75	Φ600x1.3	25
PBWS40/8-2C	8	40	CDL4-5	1.1	Φ600x1.3	25
PBWS48/8-2C	8	48	CDL4-6	1.1	Φ600x1.3	25
PBWS56/8-2C	8	56	CDL4-7	1.5	Φ600x1.3	25
PBWS64/8-2C	8	64	CDL4-8	1.5	Φ600x1.3	25
PBWS81/8-2C	8	81	CDL4-10	2.2	Φ600x1.3	25
PBWS95/8-2C	8	95	CDL4-12	2.2	Φ600x1.3	25
PBWS112/8-2C	8	112	CDL4-14	3	Φ600x1.3	25
PBWS129/8-2C	8	129	CDL4-16	3	Φ600x1.3	25
PBWS153/8-2C	8	153	CDL4-19	4	Φ600x1.3	25
PBWS178/8-2C	8	178	CDL4-22	4	Φ600x1.3	25
PBWS18/16-2C	16	18	CDL8-2	0.75	Φ600x1.3	80
PBWS27/16-2C	16	27	CDL8-3	1.1	Φ600x1.3	80
PBWS36/16-2C	16	36	CDL8-4	1.5	Φ600x1.3	80
PBWS45/16-2C	16	45	CDL8-5	2.2	Φ600x1.3	80
PBWS54/16-2C	16	54	CDL8-6	2.2	Φ600x1.3	80
PBWS73/16-2C	16	73	CDL8-8	3	Φ600x1.3	80
PBWS92/16-2C	16	92	CDL8-10	4	Φ600x1.3	80
PBWS111/16-2C	16	111	CDL8-12	4	Φ600x1.3	80
PBWS130/16-2C	16	130	CDL8-14	5.5	Φ600x1.3	80
PBWS148/16-2C	16	148	CDL8-16	5.5	Φ600x1.3	80
PBWS167/16-2C	16	167	CDL8-18	7.5	Φ600x1.3	80
PBWS186/16-2C	16	186	CDL8-20	7.5	Φ600x1.3	80
PBWS20/24-2C	24	20	CDL12-2	1.5	Φ800x1.5	150
PBWS30/24-2C	24	30	CDL12-3	2.2	Φ800x1.5	150
PBWS40/24-2C	24	40	CDL12-4	3	Φ800x1.5	150
PBWS50/24-2C	24	50	CDL12-5	3	Φ800x1.5	150
PBWS60/24-2C	24	60	CDL12-6	4	Φ800x1.5	150
PBWS70/24-2C	24	70	CDL12-7	5.5	Φ800x1.5	150
PBWS80/24-2C	24	80	CDL12-8	5.5	Φ800x1.5	150
PBWS91/24-2C	24	91	CDL12-9	5.5	Φ800x1.5	150
PBWS101/24-2C	24	101	CDL12-10	7.5	Φ800x1.5	150
PBWS121/24-2C	24	121	CDL12-12	7.5	Φ800x1.5	150
PBWS141/24-2C	24	141	CDL12-14	11	Φ800x1.5	150
PBWS162/24-2C	24	162	CDL12-16	11	Φ800x1.5	150
PBWS183/24-2C	24	183	CDL12-18	11	Φ800x1.5	150
PBWS22/32-2C	32	22	CDL16-2	2.2	Φ800x1.5	220
PBWS34/32-2C	32	34	CDL16-3	3	Φ800x1.5	220
PBWS46/32-2C	32	46	CDL16-4	4	Φ800x1.5	220
PBWS58/32-2C	32	58	CDL16-5	5.5	Φ800x1.5	220
PBWS70/32-2C	32	70	CDL16-6	5.5	Φ800x1.5	220
PBWS82/32-2C	32	82	CDL16-7	7.5	Φ800x1.5	220
PBWS94/32-2C	32	94	CDL16-8	7.5	Φ800x1.5	220
PBWS118/32-2C	32	118	CDL16-10	11	Φ800x1.5	220
PBWS141/32-2C	32	141	CDL16-12	11	Φ800x1.5	220
PBWS166/32-2C	32	166	CDL16-14	15	Φ800x1.5	220
PBWS189/32-2C	32	189	CDL16-16	15	Φ800x1.5	220

50 Hz n=2900 1/min

MODEL MODELO MODÈLE	Flow Caudal Débit	Head Altura Hauteur	Pump Bomba Pompe	Power Potencia Puissance	Tank size	User no.
	m ³ /h	m		kw	ΦxL	
PBWS23/40-2C	40	23	CDL20-2	2.2	Φ800x1.5	260
PBWS35/40-2C	40	35	CDL20-3	4	Φ800x1.5	260
PBWS47/40-2C	40	47	CDL20-4	5.5	Φ800x1.5	260
PBWS58/40-2C	40	58	CDL20-5	5.5	Φ800x1.5	260
PBWS70/40-2C	40	70	CDL20-6	7.5	Φ800x1.5	260
PBWS82/40-2C	40	82	CDL20-7	7.5	Φ800x1.5	260
PBWS94/40-2C	40	94	CDL20-8	11	Φ800x1.5	260
PBWS118/40-2C	40	118	CDL20-10	11	Φ800x1.5	260
PBWS142/40-2C	40	142	CDL20-12	15	Φ800x1.5	260
PBWS166/40-2C	40	166	CDL20-14	15	Φ800x1.5	260
PBWS202/40-2C	40	202	CDL20-17	18.5	Φ1000x2.0	260
PBWS27/64-2C	64	27	CDL32-20	4	Φ1000x2.0	500
PBWS40/64-2C	64	40	CDL32-30	5.5	Φ1000x2.0	500
PBWS53/64-2C	64	53	CDL32-40	7.5	Φ1000x2.0	500
PBWS67/64-2C	64	67	CDL32-50	11	Φ1000x2.0	500
PBWS81/64-2C	64	81	CDL32-60	11	Φ1000x2.0	500
PBWS95/64-2C	64	95	CDL32-70	15	Φ1000x2.0	500
PBWS109/64-2C	64	109	CDL32-80	15	Φ1000x2.0	500
PBWS124/64-2C	64	124	CDL32-90	18.5	Φ1000x2.0	500
PBWS138/64-2C	64	138	CDL32-100	18.5	Φ1000x2.0	500
PBWS153/64-2C	64	153	CDL32-110	22	Φ1000x2.0	500
PBWS167/64-2C	64	167	CDL32-120	22	Φ1000x2.0	500
PBWS184/64-2C	64	184	CDL32-130	30	Φ1000x2.0	500
PBWS196/64-2C	64	196	CDL32-140	30	Φ1000x2.0	500
PBWS41/84-2C	84	41	CDL42-20	7.5	Φ1000x2.0	600
PBWS61/84-2C	84	61	CDL42-30	11	Φ1000x2.0	600
PBWS81/84-2C	84	81	CDL42-40	15	Φ1000x2.0	600
PBWS101/84-2C	84	101	CDL42-50	18.5	Φ1000x2.0	600
PBWS122/84-2C	84	122	CDL42-60	22	Φ1000x2.0	600
PBWS142/84-2C	84	142	CDL42-70	30	Φ1000x2.0	600
PBWS162/84-2C	84	162	CDL42-80	30	Φ1000x2.0	600
PBWS183/64-2C	84	183	CDL42-90	37	Φ1000x2.0	600
PBWS203/64-2C	84	203	CDL42-100	37	Φ1000x2.0	600
PBWS225/84-2C	84	225	CDL42-110	45	Φ1000x2.0	600
PBWS238/84-2C	84	238	CDL42-120-2	45	Φ1000x2.0	600
PBWS247/84-2C	84	247	CDL42-120	45	Φ1000x2.0	600
PBWS259/84-2C	84	259	CDL42-130-2	45	Φ1000x2.0	600
PBWS26/130-2C	130	26	CDL65-20-2	7.5	Φ1200x2.0	1200
PBWS40/130-2C	130	40	CDL65-20	11	Φ1200x2.0	1200
PBWS60/130-2C	130	60	CDL65-30	18.5	Φ1200x2.0	1200
PBWS80/130-2C	130	80	CDL65-40	22	Φ1200x2.0	1200
PBWS95/130-2C	130	95	CDL65-50-1	30	Φ1200x2.0	1200
PBWS102/130-2C	130	102	CDL65-50	30	Φ1200x2.0	1200
PBWS110/130-2C	130	110	CDL65-60-2	30	Φ1200x2.0	1200
PBWS24/130-2C	130	124	CDL65-60	37	Φ1200x2.0	1200
PBWS132/130-2C	130	132	CDL65-70-2	37	Φ1200x2.0	1200
PBWS146/130-2C	130	146	CDL65-70	45	Φ1200x2.0	1200
PBWS154/130-2C	130	154	CDL68-80-2	45	Φ1200x2.0	1200
PBWS161/130-2C	130	161	CDL65-80-1	45	Φ1200x2.0	1200

TECHNICAL DATA/DATOS TÉCNICOS/DONNÉES TECHNIQUES

MODEL MODELO MODÈLE	Flow Caudal Débit	Head Altura Hauteur	Pump Bomba Pompe	Power Potencia Puissance	Tank size ΦxL	User no.
	m ³ /h	m		kw		
PBWS20/170-2C	170	20	CDL85-10	7.5	Φ1200x20	1600
PBWS30/170-2C	170	30	CDL85-20-2	11	Φ1200x20	1600
PBWS41/170-2C	170	41	CDL85-20	15	Φ1200x20	1600
PBWS52/170-2C	170	52	CDL85-30-2	18.5	Φ1200x20	1600
PBWS64/170-2C	170	64	CDL85-30	22	Φ1200x20	1600
PBWS75/170-2C	170	75	CDL85-40-2	30	Φ1200x20	1600
PBWS86/170-2C	170	86	CDL85-40	30	Φ1200x20	1600
PBWS98/170-2C	170	98	CDL85-50-2	37	Φ1200x20	1600
PBWS110/170-2C	170	110	CDL85-50	37	Φ1200x20	1600
PBWS122/170-2C	170	122	CDL85-60-2	45	Φ1200x20	1600
PBWS134/170-2C	170	134	CDL85-60	45	Φ1200x20	1600
PBWS15/12-3C	12	15	CDL4-2	0.37	Φ600x1.3	50
PBWS24/12-3C	12	24	CDL4-3	0.55	Φ600x1.3	50
PBWS32/12-3C	12	32	CDL4-4	0.75	Φ600x1.3	50
PBWS40/12-3C	12	40	CDL4-5	1.1	Φ600x1.3	50
PBWS48/12-3C	12	48	CDL4-6	1.1	Φ600x1.3	50
PBWS56/12-3C	12	56	CDL4-7	1.5	Φ600x1.3	50
PBWS64/12-3C	12	64	CDL4-8	1.5	Φ600x1.3	50
PBWS81/12-3C	12	81	CDL4-10	2.2	Φ600x1.3	50
PBWS95/12-3C	12	95	CDL4-12	2.2	Φ600x1.3	50
PBWS112/12-3C	12	112	CDL4-14	3	Φ600x1.3	50
PBWS129/12-3C	12	129	CDL4-16	3	Φ600x1.3	50
PBWS153/12-3C	12	153	CDL4-19	4	Φ600x1.3	50
PBWS178/12-3C	12	178	CDL4-22	4	Φ600x1.3	50
PBWS18/24-3C	24	18	CDL8-2	0.75	Φ800x1.5	150
PBWS27/24-3C	24	27	CDL8-3	1.1	Φ800x1.5	150
PBWS36/24-3C	24	36	CDL8-4	1.5	Φ800x1.5	150
PBWS45/24-3C	24	45	CDL8-5	2.2	Φ800x1.5	150
PBWS54/24-3C	24	54	CDL8-6	2.2	Φ800x1.5	150
PBWS73/24-3C	24	73	CDL8-8	3	Φ800x1.5	150
PBWS92/34-3C	24	92	CDL8-10	4	Φ800x1.5	150
PBWS111/24-3C	24	111	CDL8-12	4	Φ800x1.5	150
PBWS130/24-3C	24	130	CDL8-14	5.5	Φ800x1.5	150
PBWS148/24-3C	24	148	CDL8-16	5.5	Φ800x1.5	150
PBWS167/24-3C	24	167	CDL8-18	7.5	Φ800x1.5	150
PBWS186/24-3C	24	186	CDL8-20	7.5	Φ800x1.5	150
PBWS20/36-3C	36	20	CDL12-2	1.5	Φ800x1.5	220
PBWS30/36-3C	36	30	CDL12-3	2.2	Φ800x1.5	220
PBWS40/36-3C	36	40	CDL12-4	3	Φ800x1.5	220
PBWS50/36-3C	36	50	CDL12-5	3	Φ800x1.5	220
PBWS60/36-3C	36	60	CDL12-6	4	Φ800x1.5	220
PBWS70/36-3C	36	70	CDL12-7	5.5	Φ800x1.5	220
PBWS80/36-3C	36	80	CDL12-8	5.5	Φ800x1.5	220
PBWS91/36-3C	36	91	CDL12-9	5.5	Φ800x1.5	220
PBWS101/36-3C	36	101	CDL12-10	7.5	Φ800x1.5	220
PBWS121/36-3C	36	121	CDL12-12	7.5	Φ800x1.5	220
PBWS141/36-3C	36	141	CDL12-14	11	Φ800x1.5	220
PBWS162/36-3C	36	162	CDL12-16	11	Φ800x1.5	220
PBWS183/36-3C	36	183	CDL12-18	11	Φ800x1.5	220

50 Hz n=2900 1/min

MODEL MODELO MODÈLE	Flow Caudal Débit	Head Altura Hauteur	Pump Bomba Pompe	Power Potencia Puissance	Tank size ΦxL	User no.
	m ³ /h	m		kw		
PBWS22/48-3C	48	22	CDL16-2	2.2	Φ800x1.5	300
PBWS34/48-3C	48	34	CDL16-3	3	Φ800x1.5	300
PBWS46/48-3C	48	46	CDL16-4	4	Φ800x1.5	300
PBWS58/48-3C	48	58	CDL16-5	5.5	Φ800x1.5	300
PBWS70/48-3C	48	70	CDL16-6	5.5	Φ800x1.5	300
PBWS82/48-3C	48	82	CDL16-7	7.5	Φ800x1.5	300
PBWS94/48-3C	48	94	CDL16-8	7.5	Φ800x1.5	300
PBWS118/48-3C	48	118	CDL16-10	11	Φ800x1.5	300
PBWS141/48-3C	48	141	CDL16-12	11	Φ800x1.5	300
PBWS166/48-3C	48	166	CDL16-14	15	Φ800x1.5	300
PBWS189/48-3C	48	189	CDL16-16	15	Φ800x1.5	300
PBWS23/60-3C	60	23	CDL20-2	2.5	Φ1000x2.0	500
PBWS35/60-3C	60	35	CDL20-3	4	Φ1000x2.0	500
PBWS47/60-3C	60	47	CDL20-4	5.5	Φ1000x2.0	500
PBWS58/60-3C	60	58	CDL20-5	5.5	Φ1000x2.0	500
PBWS70/63-3C	60	70	CDL20-6	7.5	Φ1000x2.0	500
PBWS82/60-3C	60	82	CDL20-7	7.5	Φ1000x2.0	500
PBWS94/60-3C	60	94	CDL20-8	11	Φ1000x2.0	500
PBWS118/60-3C	60	118	CDL20-10	11	Φ1000x2.0	500
PBWS142/60-3C	60	142	CDL20-12	15	Φ1000x2.0	500
PBWS166/60-3C	60	166	CDL20-14	15	Φ1000x2.0	500
PBWS202/60-3C	60	202	CDL20-17	18.5	Φ1000x2.0	500
PBWS27/96-3C	96	27	CDL32-20	4	Φ1000x2.0	900
PBWS40/96-3C	96	40	CDL32-30	5.5	Φ1000x2.0	900
PBWS53/96-3C	96	53	CDL32-40	7.5	Φ1000x2.0	900
PBWS67/96-3C	96	67	CDL32-50	11	Φ1000x2.0	900
PBWS81/96-3C	96	81	CDL32-60	11	Φ1000x2.0	900
PBWS95/96-3C	96	95	CDL32-70	15	Φ1000x2.0	900
PBWS109/96-3C	96	109	CDL32-80	15	Φ1000x2.0	900
PBWS124/96-3C	96	124	CDL32-90	18.5	Φ1000x2.0	900
PBWS138/96-3C	96	138	CDL32-100	18.5	Φ1000x2.0	900
PBWS153/96-3C	96	153	CDL32-110	22	Φ1000x2.0	900
PBWS167/96-3C	96	167	CDL32-120	22	Φ1000x2.0	900
PBWS181/96-3C	96	181	CDL32-130	30	Φ1000x2.0	900
PBWS196/96-3C	96	196	CDL32-140	30	Φ1200x2.0	900
PBWS41/126-3C	126	41	CDL42-20	7.5	Φ1200x2.0	1200
PBWS61/126-3C	126	61	CDL42-30	11	Φ1200x2.0	1200
PBWS81/126-3C	126	81	CDL42-40	15	Φ1200x2.0	1200
PBWS101/126-3C	126	101	CDL42-50	18.5	Φ1200x2.0	1200
PBWS122/126-3C	126	122	CDL42-60	22	Φ1200x2.0	1200
PBWS142/126-3C	126	142	CDL42-70	30	Φ1200x2.0	1200
PBWS162/126-3C	126	162	CDL42-80	30	Φ1200x2.0	1200
PBWS183/126-3C	126	183	CDL42-90	37	Φ1200x2.0	1200
PBWS203/126-3C	126	203	CDL42-100	37	Φ1200x2.0	1200
PBWS225/126-3C	126	225	CDL42-110	45	Φ1200x2.0	1200
PBWS238/126-3C	126	238	CDL42-120-2	45	Φ1200x2.0	1200
PBWS247/126-3C	126	247	CDL42-120	45	Φ1200x2.0	1200
PBWS259/126-3C	126	259	CDL42-130-2	45	Φ1200x2.0	1200
PBWS26/195-3C	195	26	CDL65-20-2	7.5	Φ1200x2.0	1600

TECHNICAL DATA/DATOS TÉCNICOS/DONNÉES TECHNIQUES

MODEL MODELO MODÈLE	Flow Caudal Débit	Head Altura Hauteur	Pump Bomba Pompe	Power Potencia Puissance	Tank size ΦxL	User no.
	m ³ /h	m		kw		
PBWS40/195-3C	195	40	CDL65-20	11	Φ1200x2.0	1600
PBWS60/195-3C	195	60	CDL65-30	18.5	Φ1200x2.0	1600
PBWS80/195-3C	195	80	CDL65-40	22	Φ1200x2.0	1600
PBWS95/195-3C	195	95	CDL65-50-1	30	Φ1200x2.0	1600
PBWS102/195-3C	195	102	CDL65-50	30	Φ1200x2.0	1600
PBWS110/195-3C	195	110	CDL65-60-2	30	Φ1200x2.0	1600
PBWS124/195-3C	195	124	CDL65-60	37	Φ1200x2.0	1600
PBWS132/195-3C	195	132	CDL65-70-2	37	Φ1200x2.0	1600
PBWS146/195-3C	195	146	CDL65-70	45	Φ1200x2.0	1600
PBWS154/195-3C	195	154	CDL65-80-2	45	Φ1200x2.0	1600
PBWS161/195-3C	195	161	CDL65-80-1	45	Φ1200x2.0	1600
PBWS20/255-3C	255	20	CDL85-10	7.5	Φ1400x2.5	2200
PBWS30/255-3C	255	30	CDL85-20-2	11	Φ1400x2.5	2200
PBWS41/255-3C	255	41	CDL85-20	15	Φ1400x2.5	2200
PBWS52/255-3C	255	52	CDL85-30-2	18.5	Φ1400x2.5	2200
PBWS64/255-3C	255	64	CDL85-30	22	Φ1400x2.5	2200
PBWS75/255-3C	255	75	CDL85-40-2	30	Φ1400x2.5	2200
PBWS86/255-3C	255	86	CDL85-40	30	Φ1400x2.5	2200
PBWS98/255-3C	255	98	CDL85-50-2	37	Φ1400x2.5	2200
PBWS110/255-3C	255	110	CDL85-50	37	Φ1400x2.5	2200
PBWS122/255-3C	255	122	CDL85-60-2	45	Φ1400x2.5	2200
PBWS134/255-3C	255	134	CDL85-60	45	Φ1400x2.5	2200
PBWS33/8-2G	8	33	25GDL4-11x3	1.1	Φ600x1.3	25
PBWS44/8-2G	8	44	25GDL4-11x4	1.5	Φ600x1.3	25
PBWS55/8-2G	8	55	25GDL4-11x5	2.2	Φ600x1.3	25
PBWS66/8-2G	8	66	25GDL4-11x6	2.2	Φ600x1.3	25
PBWS77/8-2G	8	77	25GDL4-11x7	3	Φ600x1.3	25
PBWS88/8-2G	8	88	25GDL4-11x8	3	Φ600x1.3	25
PBWS99/8-2G	8	99	25GDL4-11x9	3	Φ600x1.3	25
PBWS110/8-2G	8	110	25GDL4-11x10	4	Φ600x1.3	25
PBWS121/8-2G	8	121	25GDL4-11x11	4	Φ600x1.3	25
PBWS132/8-2G	8	132	25GDL4-11x12	4	Φ600x1.3	25
PBWS36/12-2G	12	36	40GDL6-12x3	1.5	Φ600x1.3	60
PBWS48/12-2G	12	48	40GDL6-12x4	2.2	Φ600x1.3	60
PBWS60/12-2G	12	60	40GDL6-12x5	2.2	Φ600x1.3	60
PBWS72/12-2G	12	72	40GDL6-12x6	3	Φ600x1.3	60
PBWS84/12-2G	12	84	40GDL6-12x7	3	Φ600x1.3	60
PBWS96/12-2G	12	96	40GDL6-12x8	4	Φ600x1.3	60
PBWS108/12-2G	12	108	40GDL6-12x9	4	Φ600x1.3	60
PBWS120/12-2G	12	120	40GDL6-12x10	4	Φ600x1.3	60
PBWS132/12-2G	12	132	40GDL6-12x11	5.5	Φ600x1.3	60
PBWS144/12-2G	12	144	40GDL6-12x12	5.5	Φ600x1.3	60
PBWS30/24-2G	24	30	50GDL12-15x2	2.2	Φ800x1.5	150
PBWS45/24-2G	24	45	50GDL12-15x3	3	Φ800x1.5	150
PBWS60/24-2G	24	60	50GDL12-15x4	4	Φ800x1.5	150
PBWS75/24-2G	24	75	50GDL12-15x5	5.5	Φ800x1.5	150
PBWS90/24-2G	24	90	50GDL12-15x6	5.5	Φ800x1.5	150
PBWS105/24-2G	24	105	50GDL12-15x7	7.5	Φ800x1.5	150
PBWS120/24-2G	24	120	50GDL12-15x8	7.5	Φ800x1.5	150

50 Hz n=2900 1/min

MODEL MODELO MODÈLE	Flow Caudal Débit	Head Altura Hauteur	Pump Bomba Pompe	Power Potencia Puissance	Tank size ΦxL	User no.
	m ³ /h	m		kw		
PBWS135/24-2G	24	135	50GDL12-15x9	11	Φ800x1.5	150
P						

32-125

2900rpm

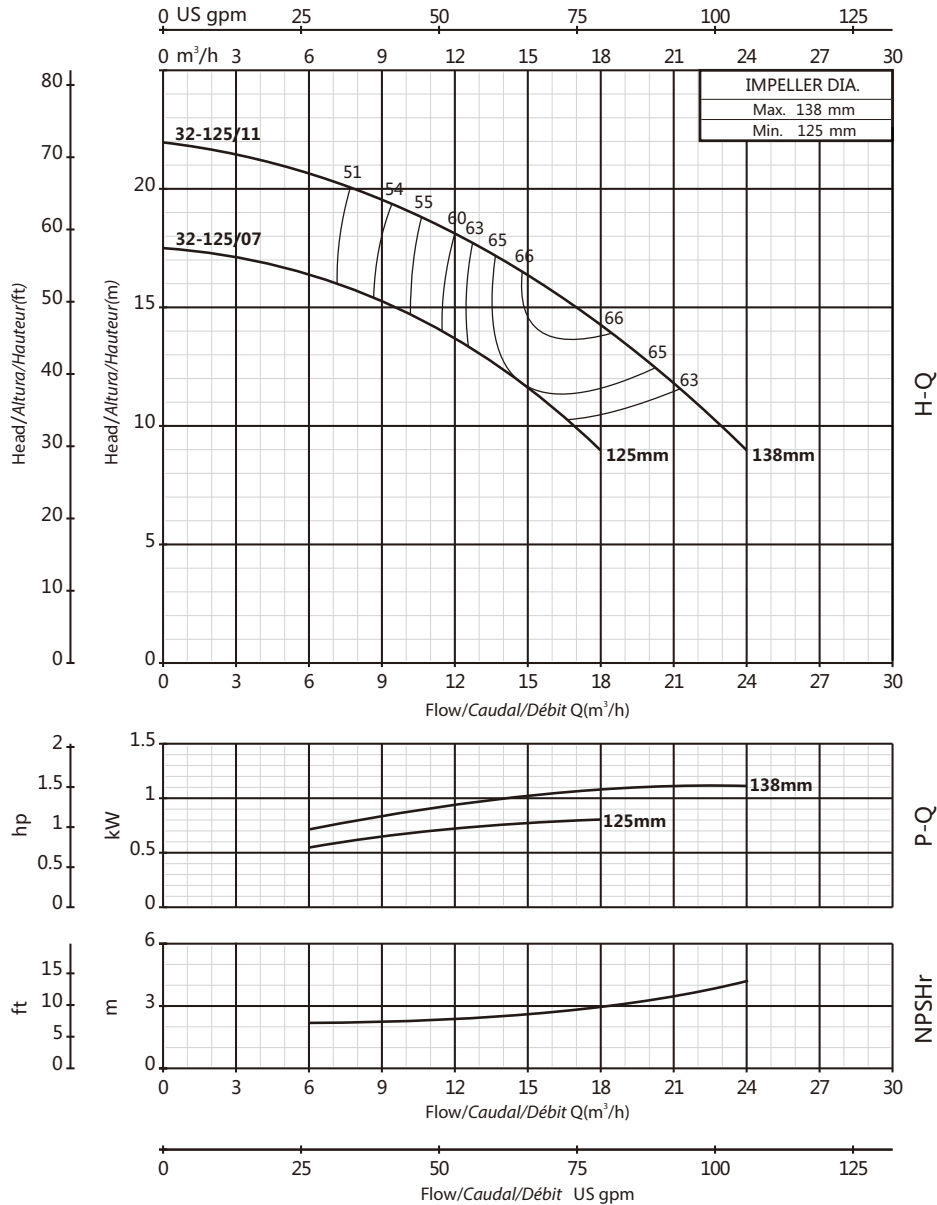

32-160

2900rpm

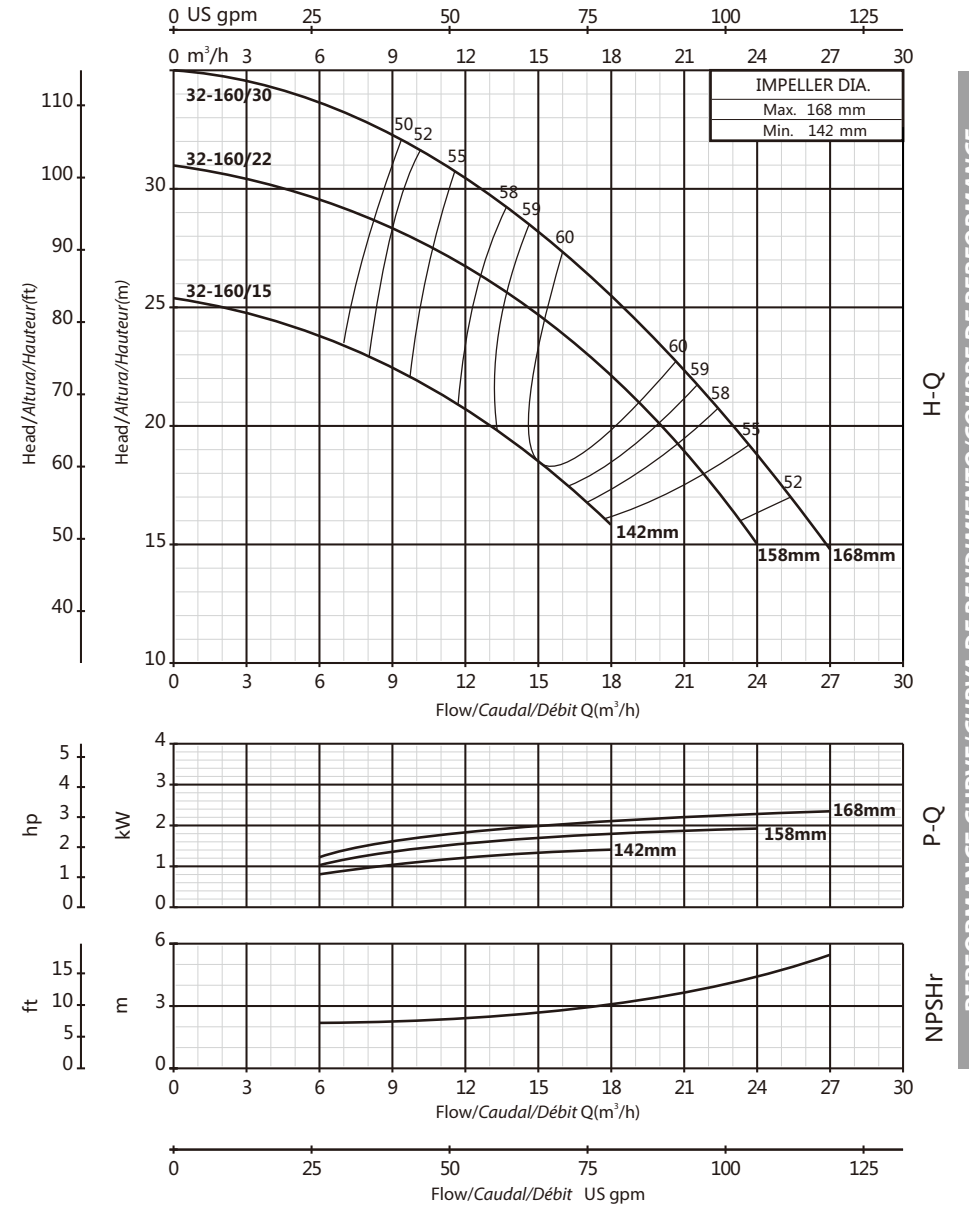

PERFORMANCE CURVE/CURVA DE RENDIMIENTO/COURBE DE PERFORMANCE

PERFORMANCE CURVE/CURVA DE RENDIMIENTO/COURBE DE PERFORMANCE

32-200

2900rpm

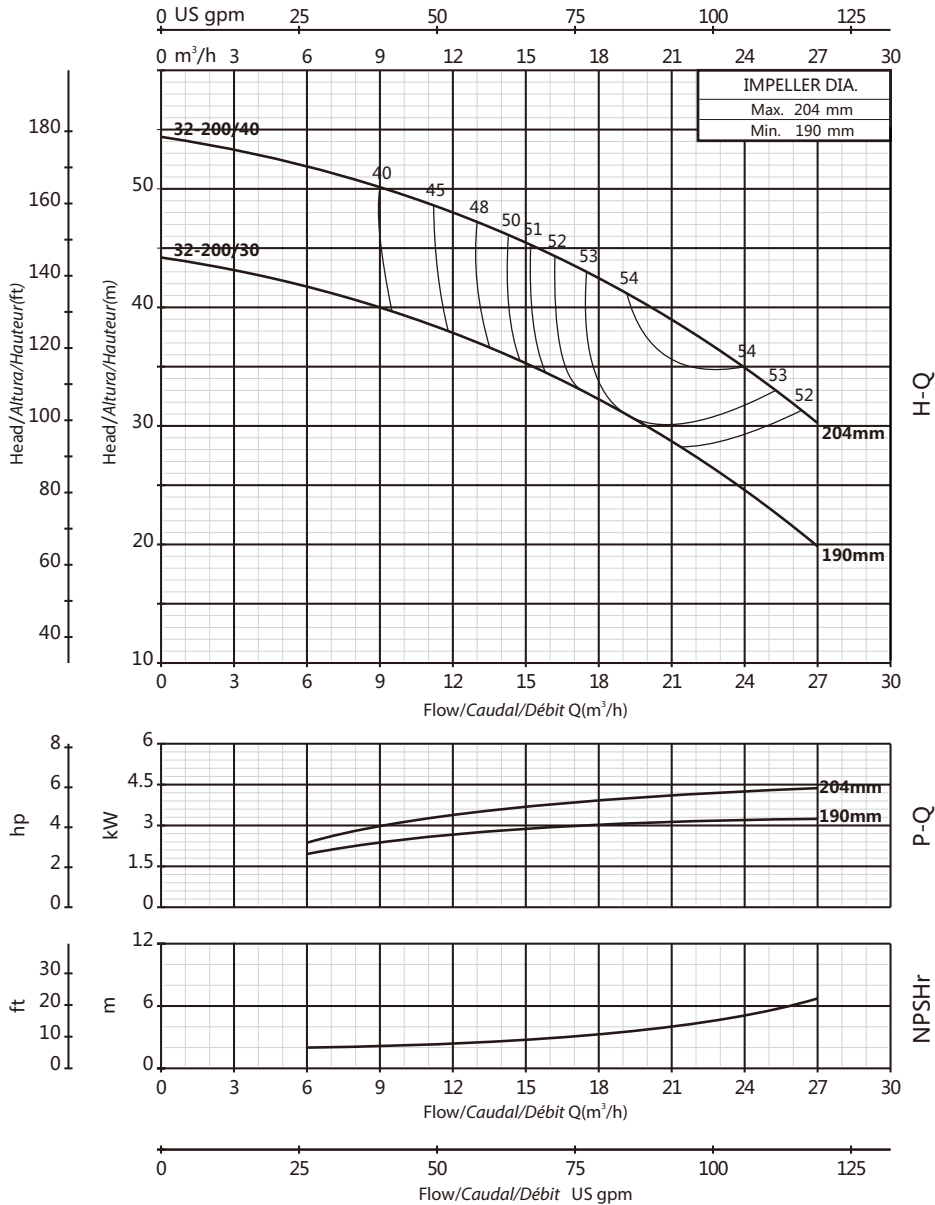

32-250

2900rpm

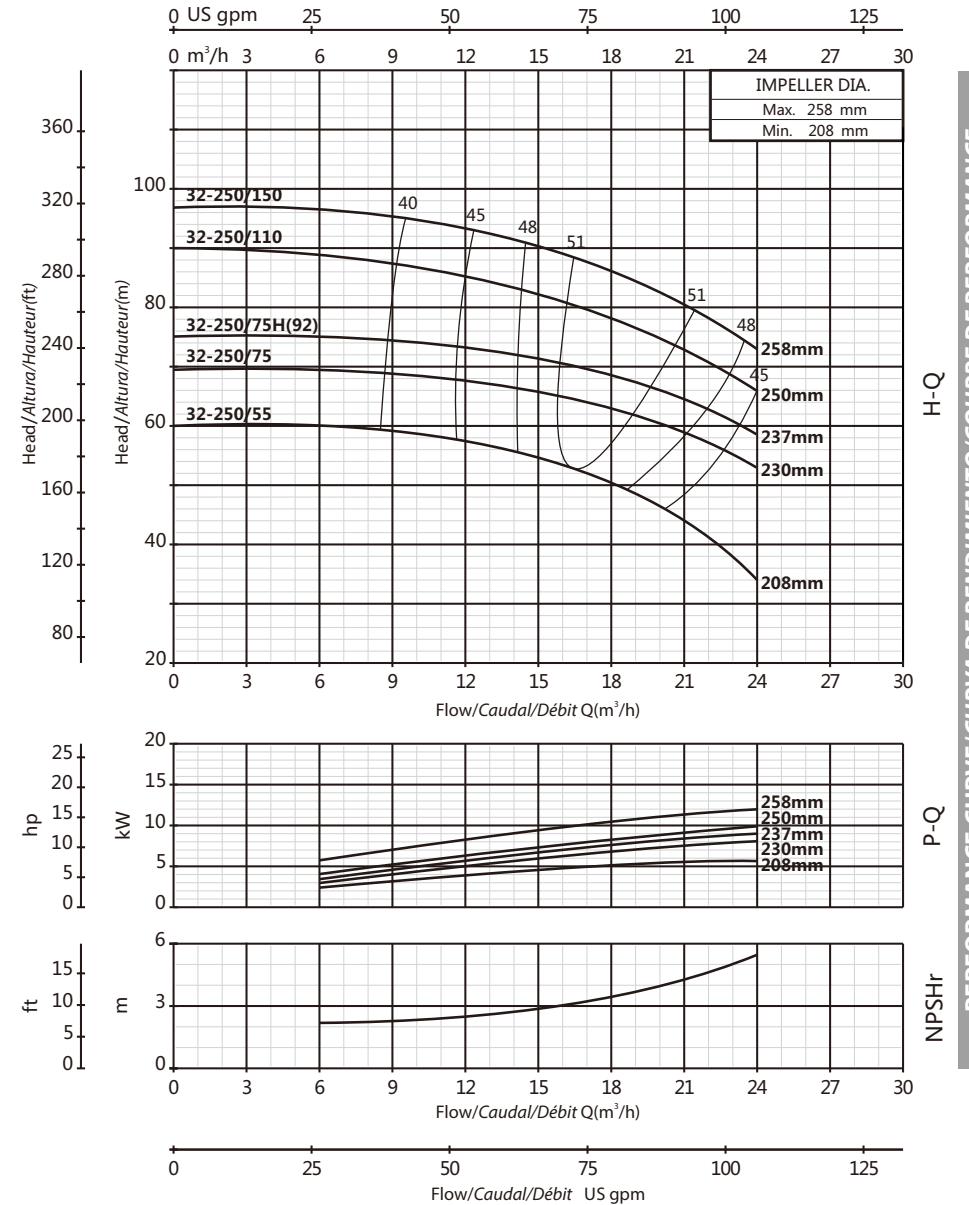

PERFORMANCE CURVE/CURVA DE RENDIMIENTO/COURBE DE PERFORMANCE

PERFORMANCE CURVE/CURVA DE RENDIMIENTO/COURBE DE PERFORMANCE

32-250D

2900rpm

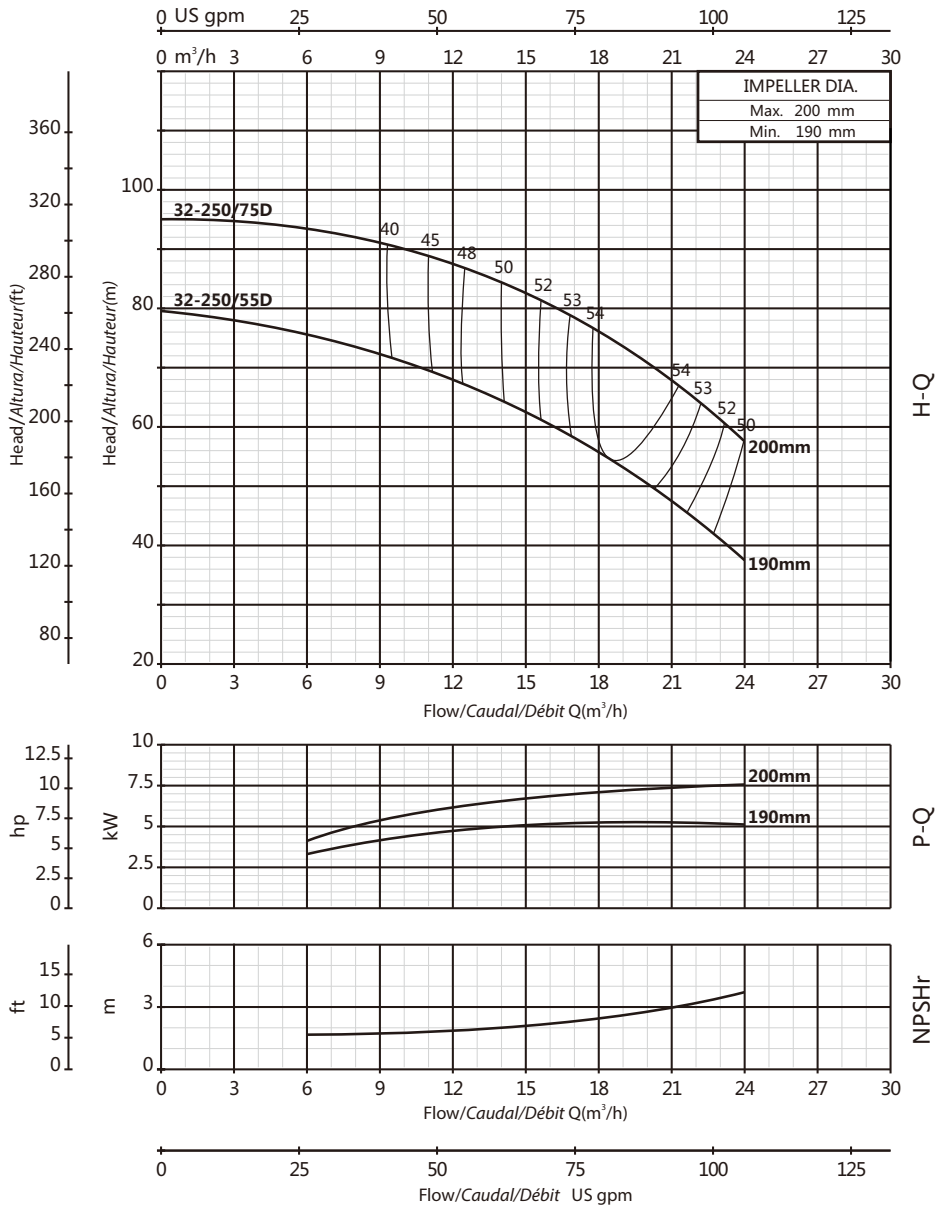

40-125

2900rpm

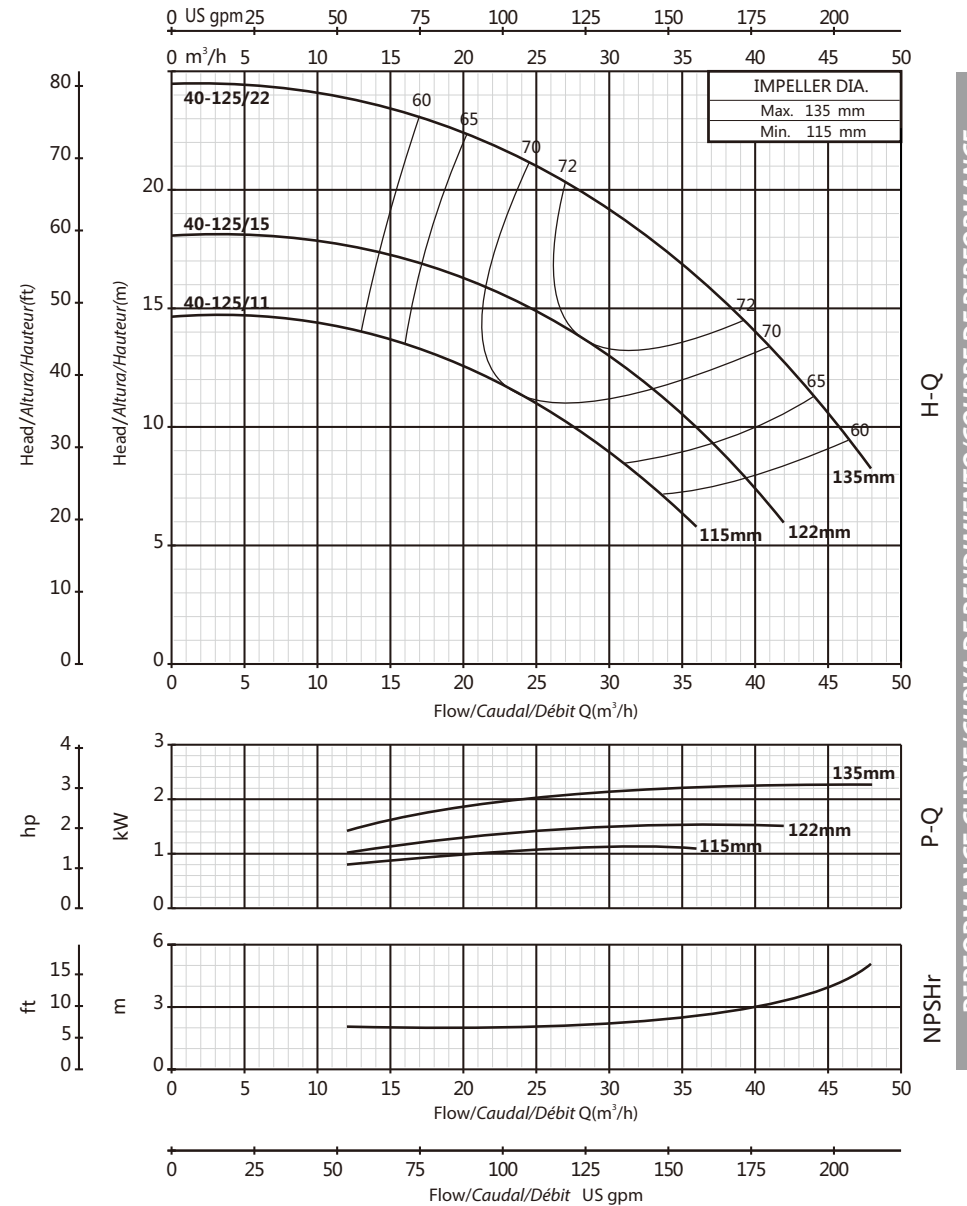

PERFORMANCE CURVE/CURVA DE RENDIMIENTO/COURBE DE PERFORMANCE

PERFORMANCE CURVE/CURVA DE RENDIMIENTO/COURBE DE PERFORMANCE

40-160

2900rpm

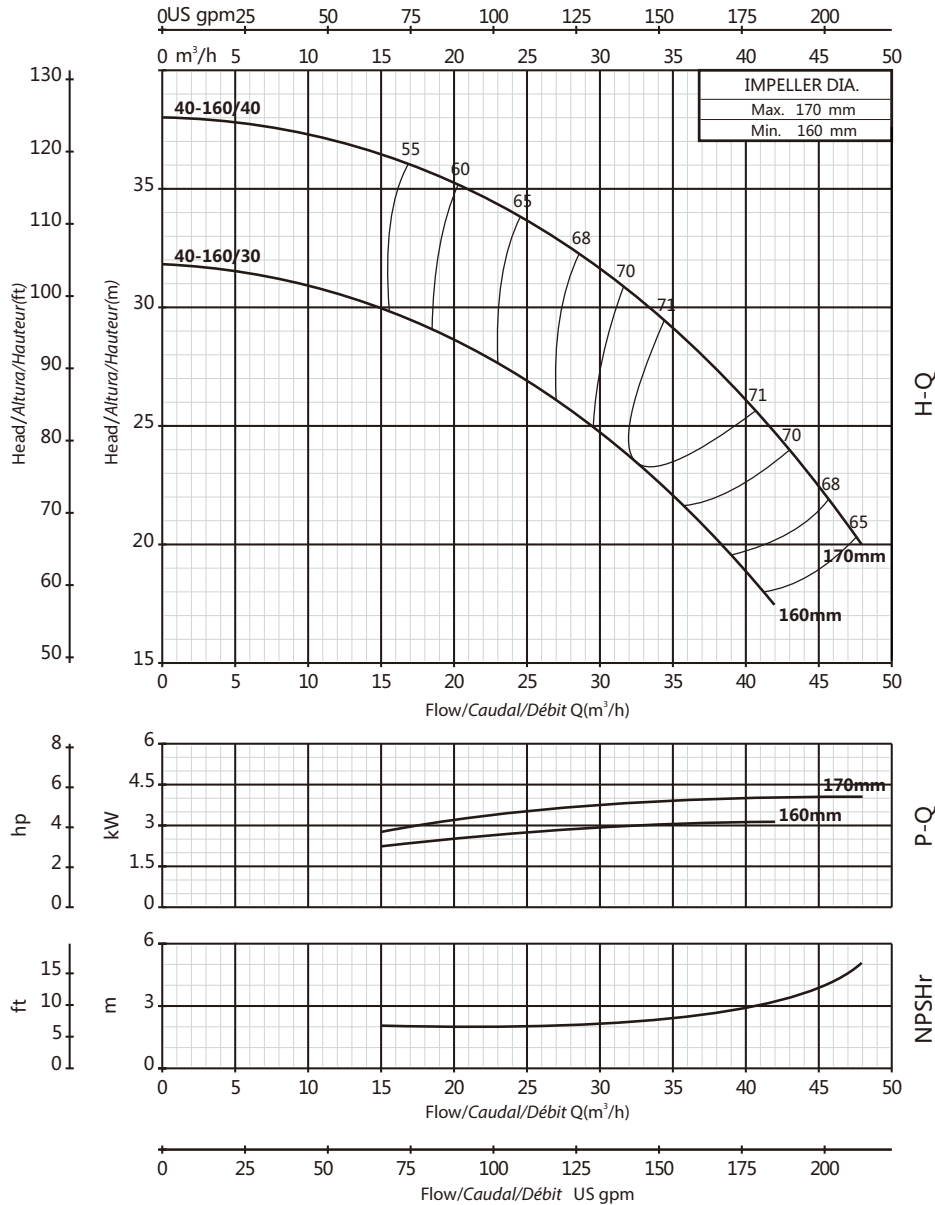

40-200

2900rpm

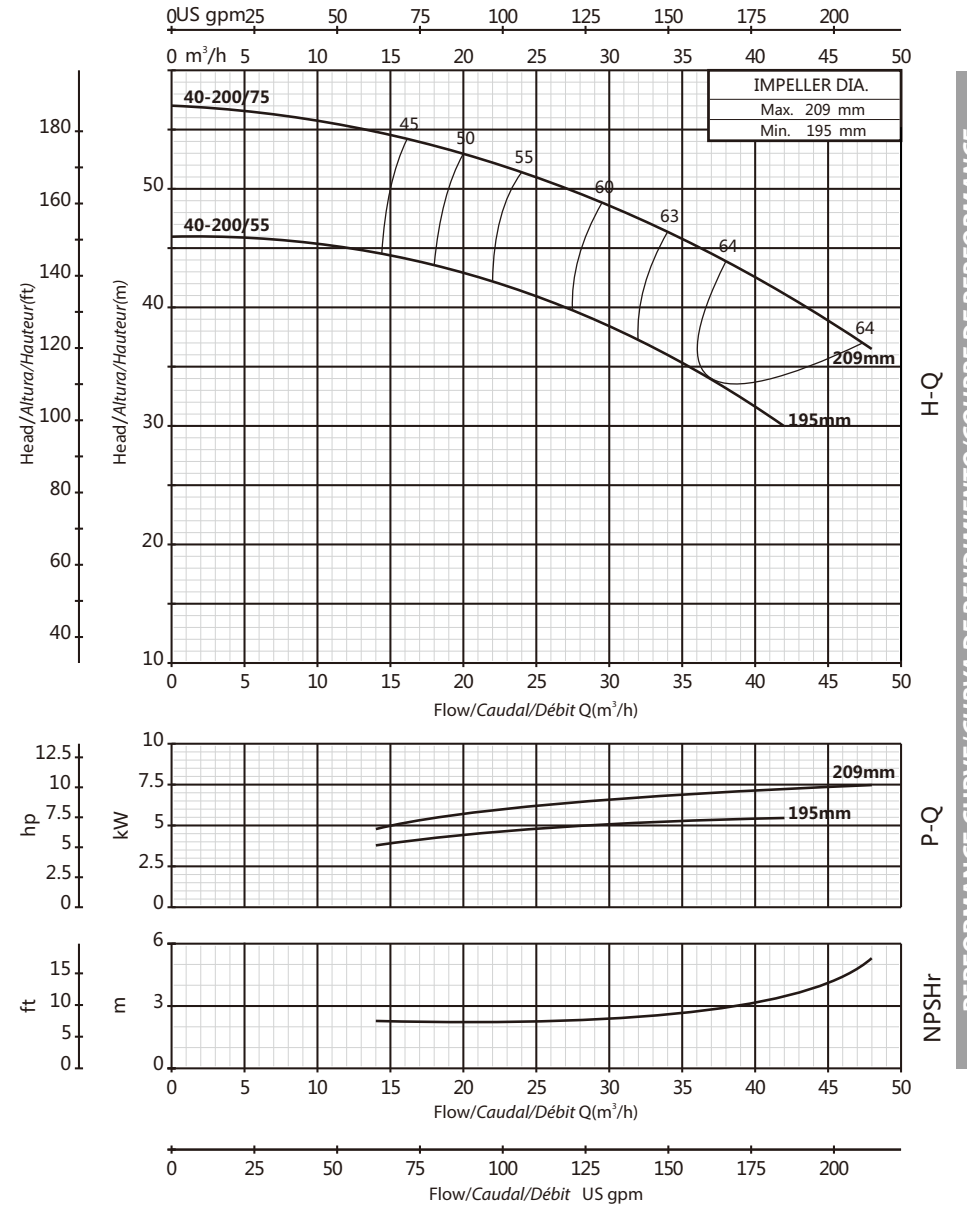

PERFORMANCE CURVE/CURVA DE RENDIMIENTO/COURBE DE PERFORMANCE

PERFORMANCE CURVE/CURVA DE RENDIMIENTO/COURBE DE PERFORMANCE

40-250

2900rpm

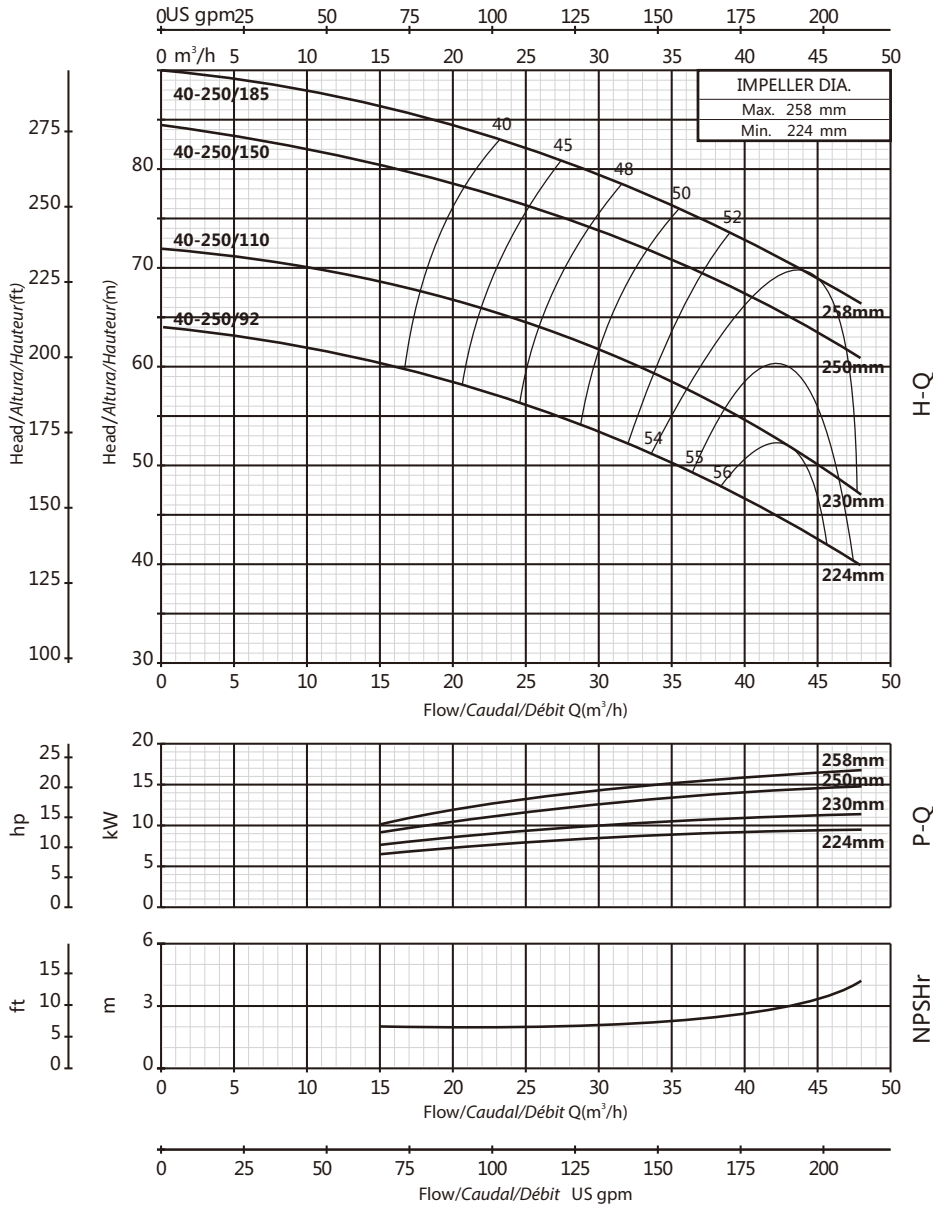

40-315

2900rpm

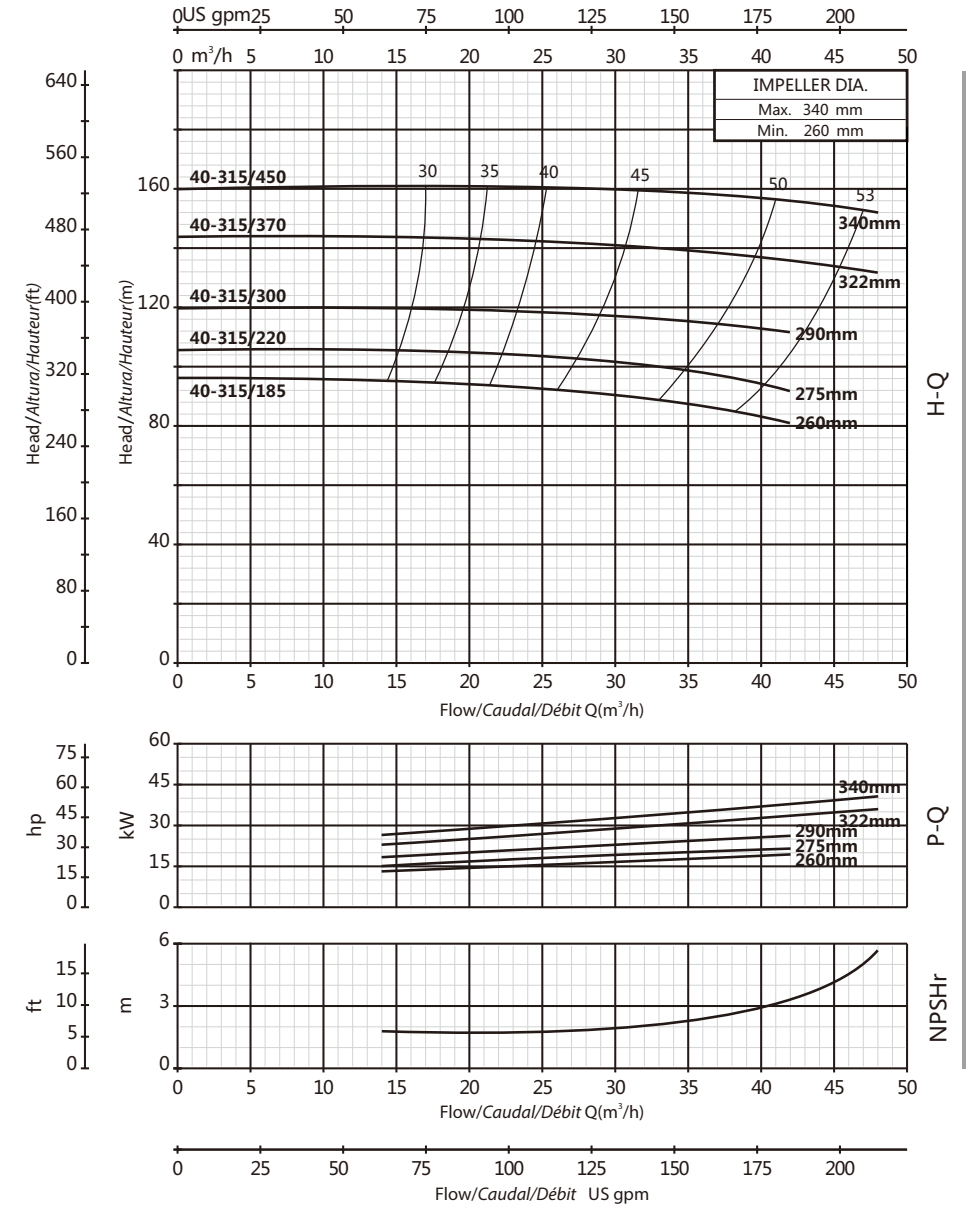

PERFORMANCE CURVE/CURVA DE RENDIMIENTO/COURBE DE PERFORMANCE

PERFORMANCE CURVE/CURVA DE RENDIMIENTO/COURBE DE PERFORMANCE

50-125

2900rpm

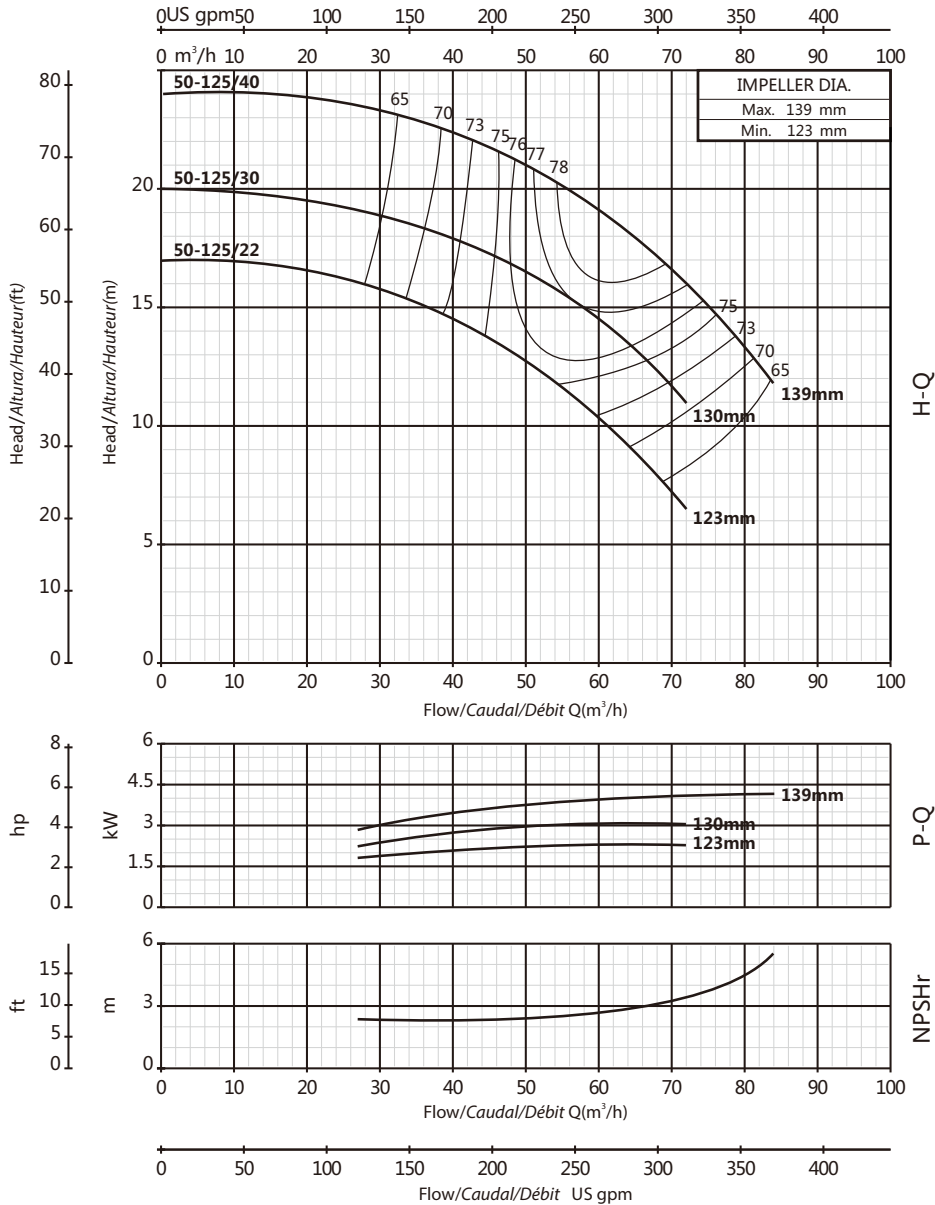

50-160

2900rpm

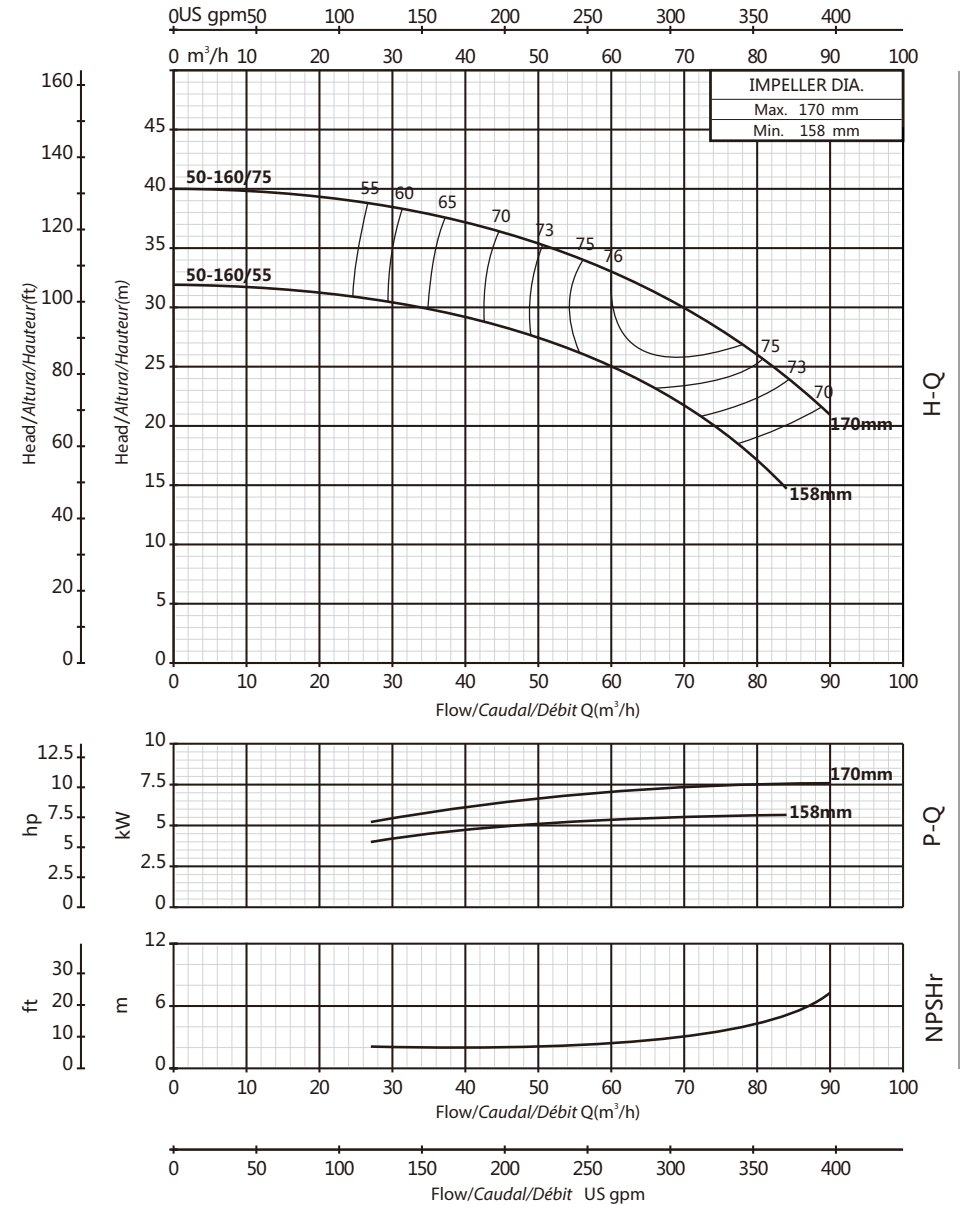

PERFORMANCE CURVE/CURVA DE RENDIMIENTO/COURBE DE PERFORMANCE

PERFORMANCE CURVE/CURVA DE RENDIMIENTO/COURBE DE PERFORMANCE

50-200

2900rpm

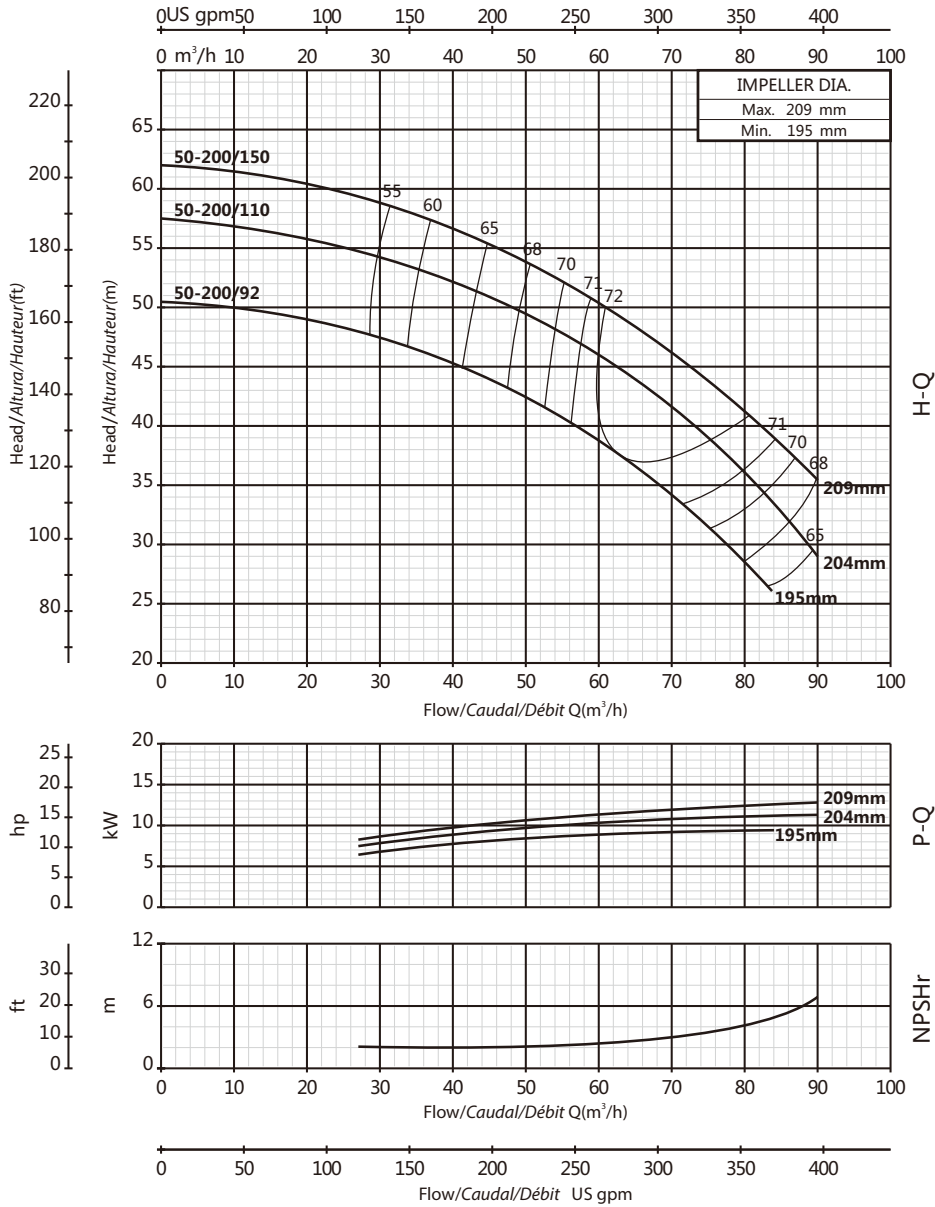

50-250

2900rpm

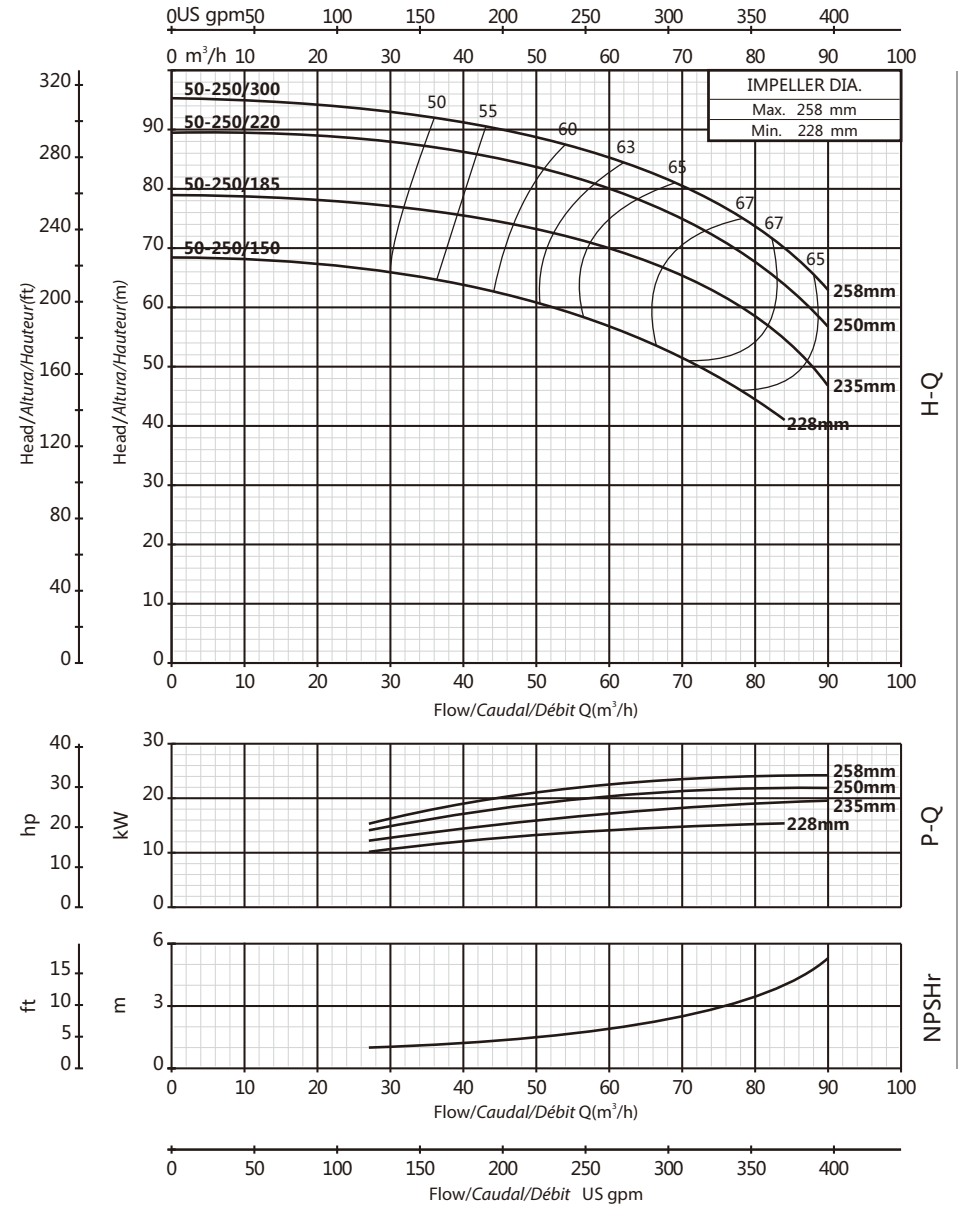

PERFORMANCE CURVE/CURVA DE RENDIMIENTO/COURBE DE PERFORMANCE

PERFORMANCE CURVE/CURVA DE RENDIMIENTO/COURBE DE PERFORMANCE

50-315

2900rpm

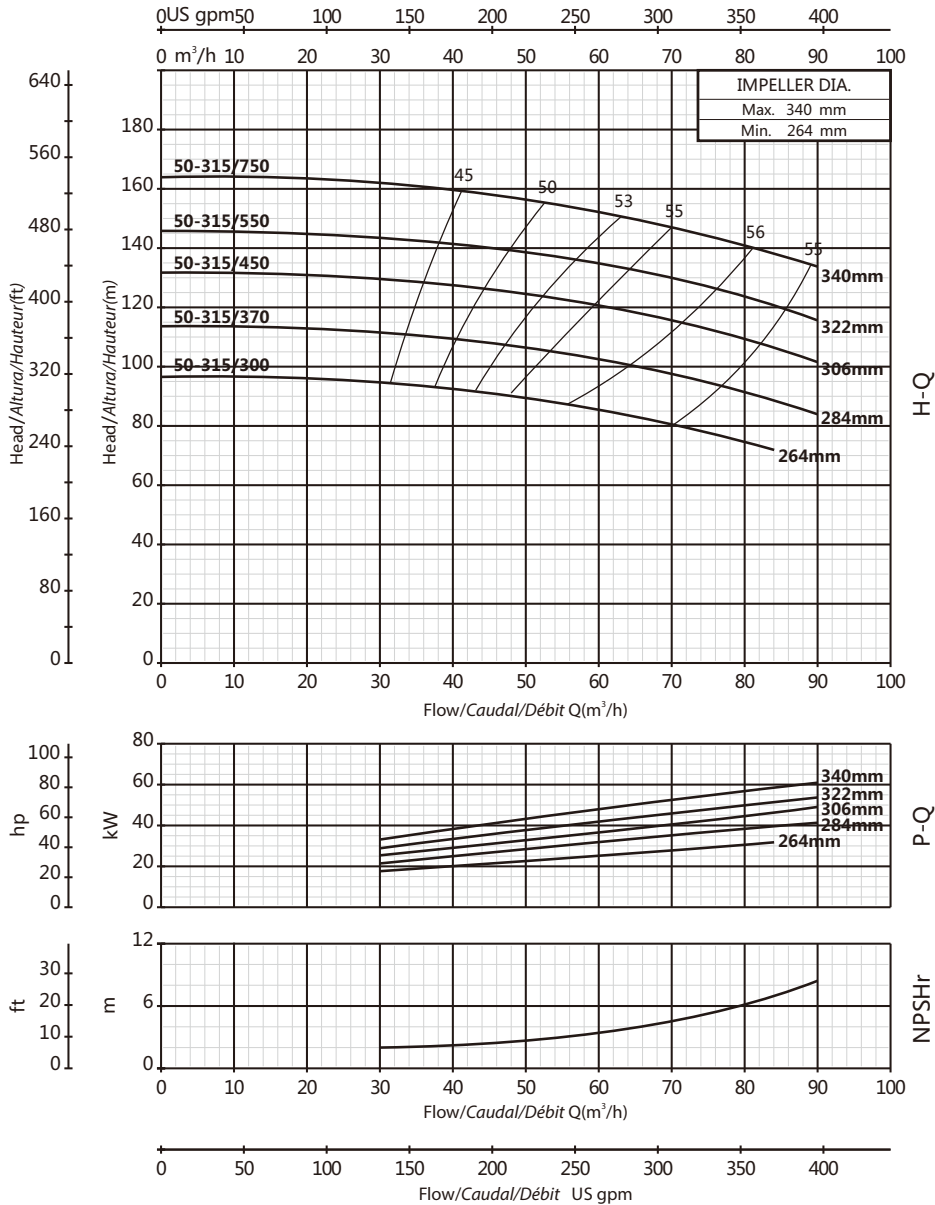

65-125

2900rpm

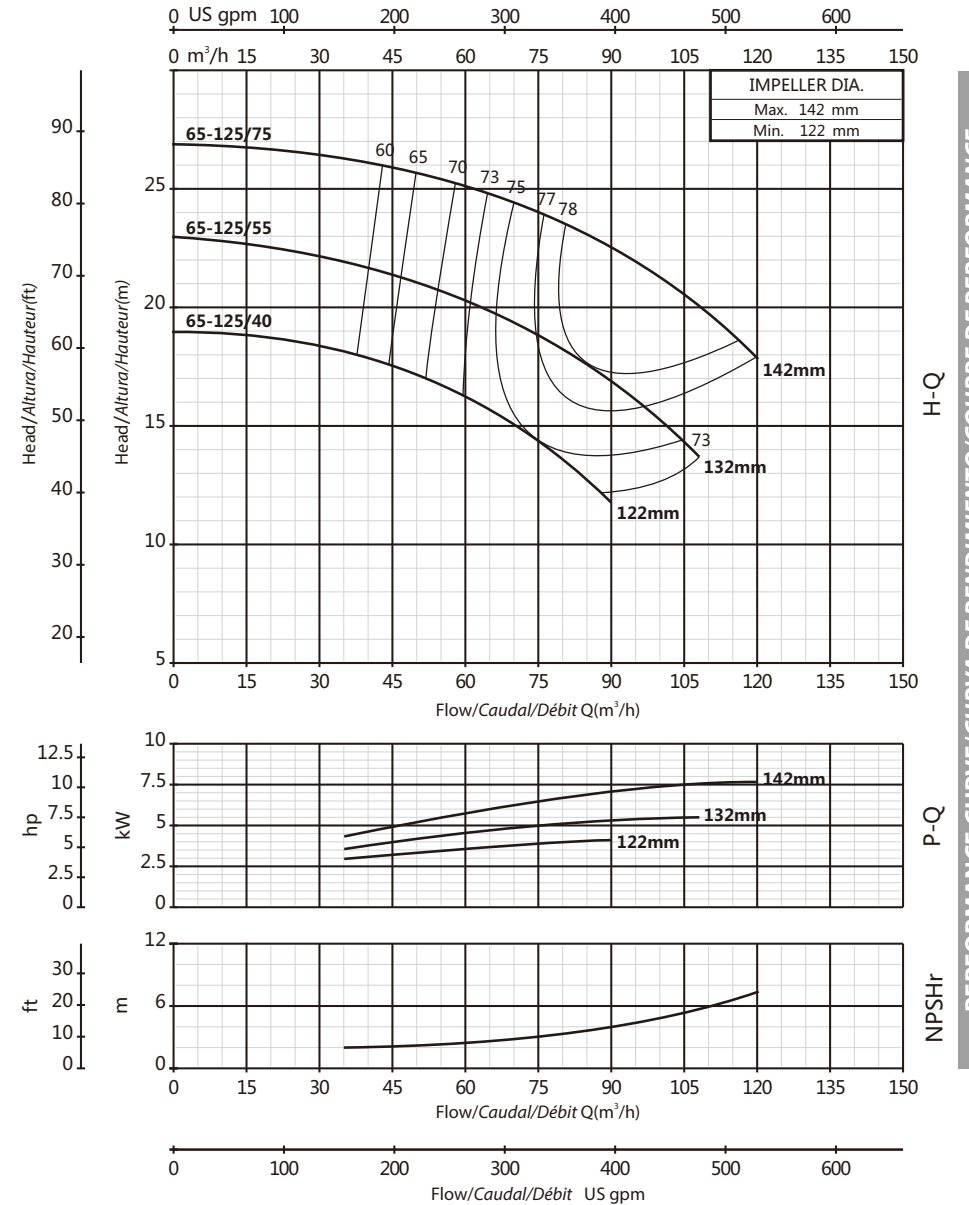

PERFORMANCE CURVE/CURVA DE RENDIMIENTO/COURBE DE PERFORMANCE

PERFORMANCE CURVE/CURVA DE RENDIMIENTO/COURBE DE PERFORMANCE

65-160

2900rpm

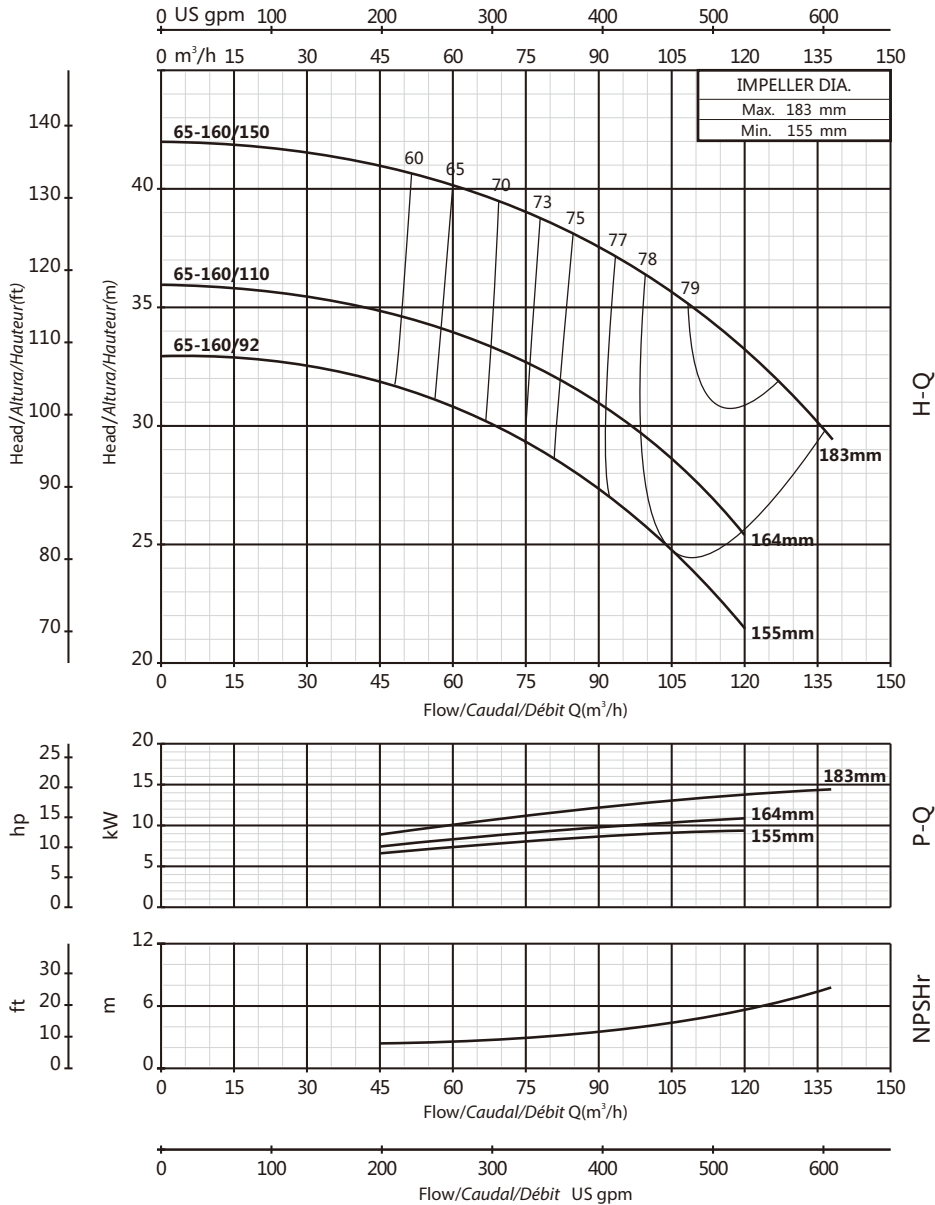

65-200

2900rpm

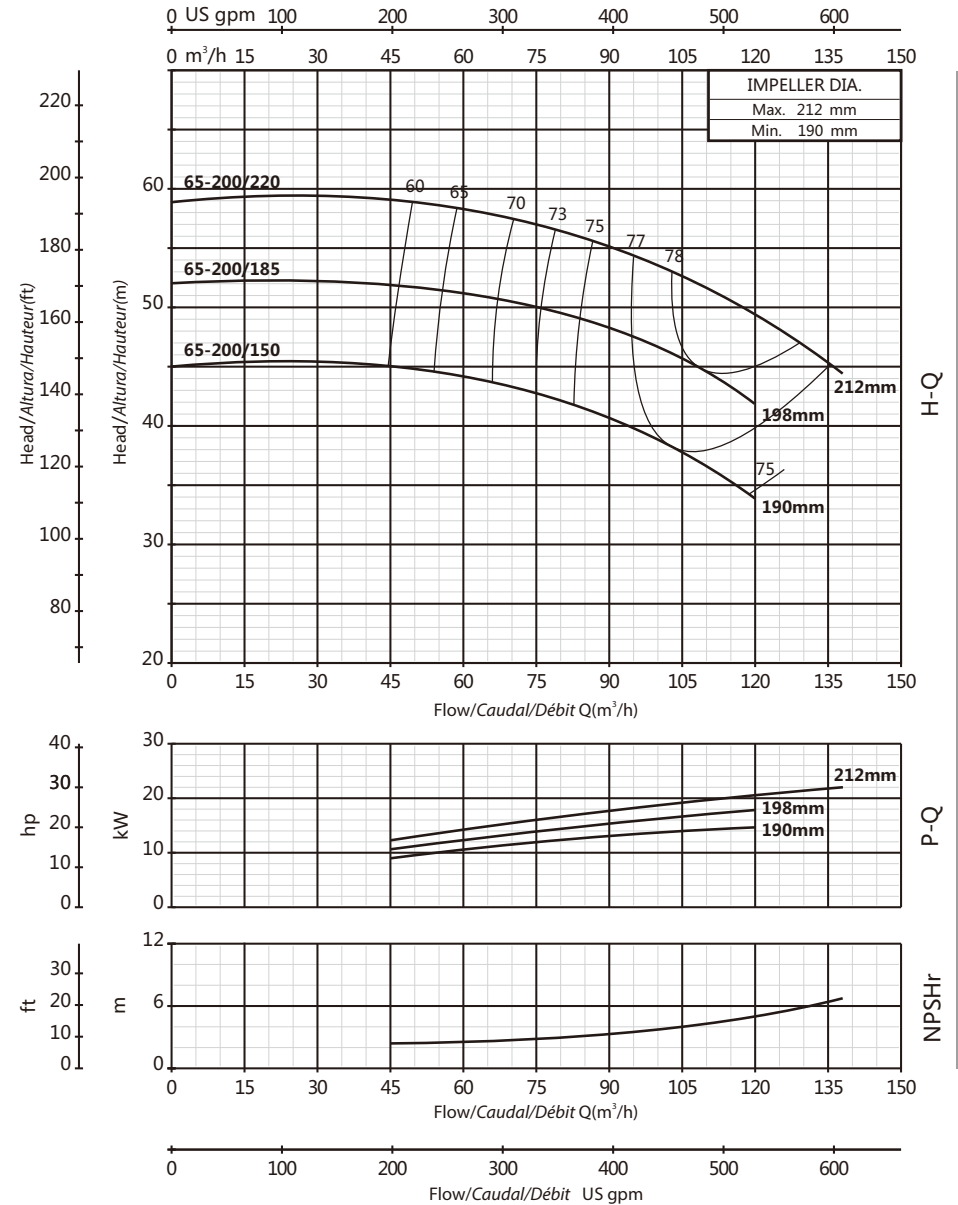

PERFORMANCE CURVE/CURVA DE RENDIMIENTO/COURBE DE PERFORMANCE

PERFORMANCE CURVE/CURVA DE RENDIMIENTO/COURBE DE PERFORMANCE

65-250

2900rpm

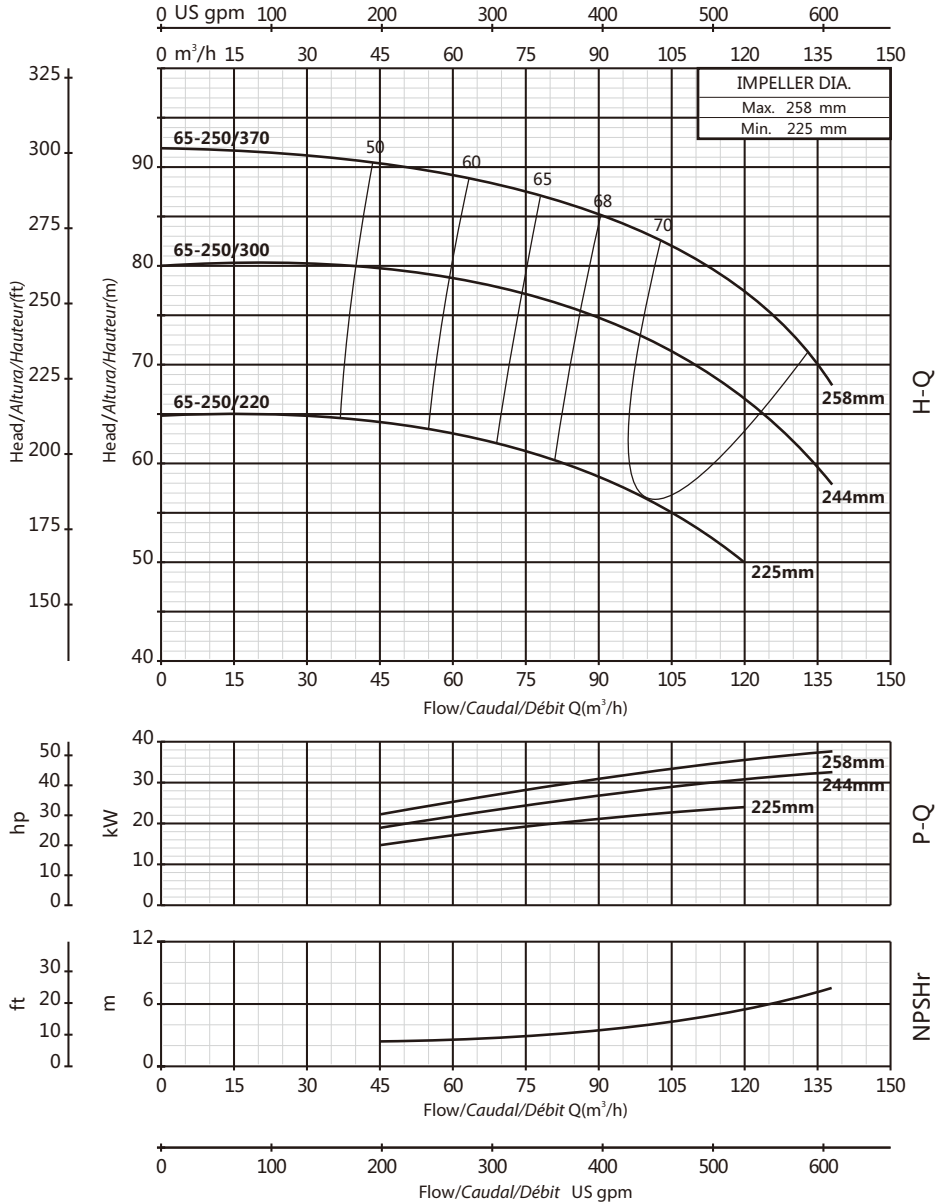

65-315

2900rpm

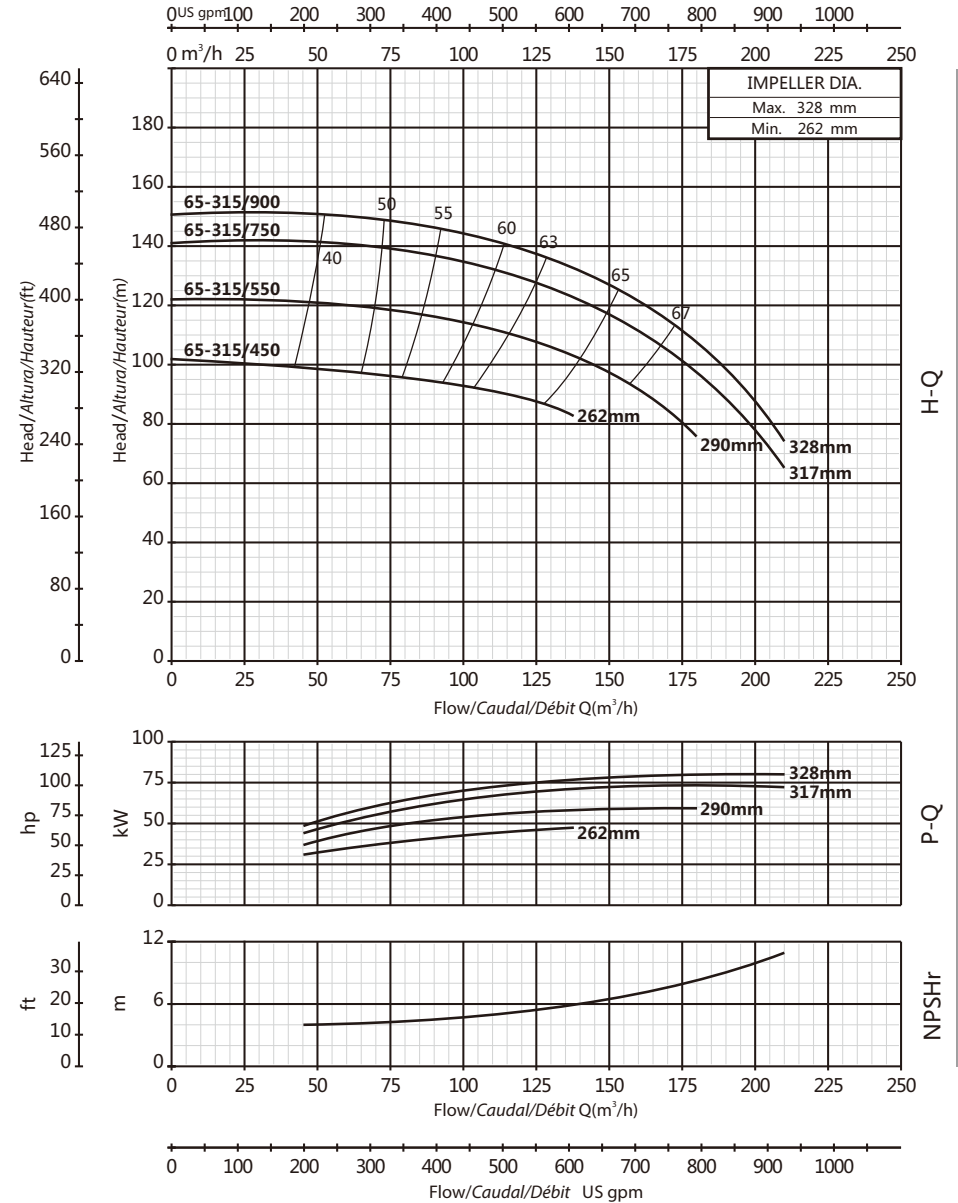

PERFORMANCE CURVE/CURVA DE RENDIMIENTO/COURBE DE PERFORMANCE

PERFORMANCE CURVE/CURVA DE RENDIMIENTO/COURBE DE PERFORMANCE

80-125

2900rpm

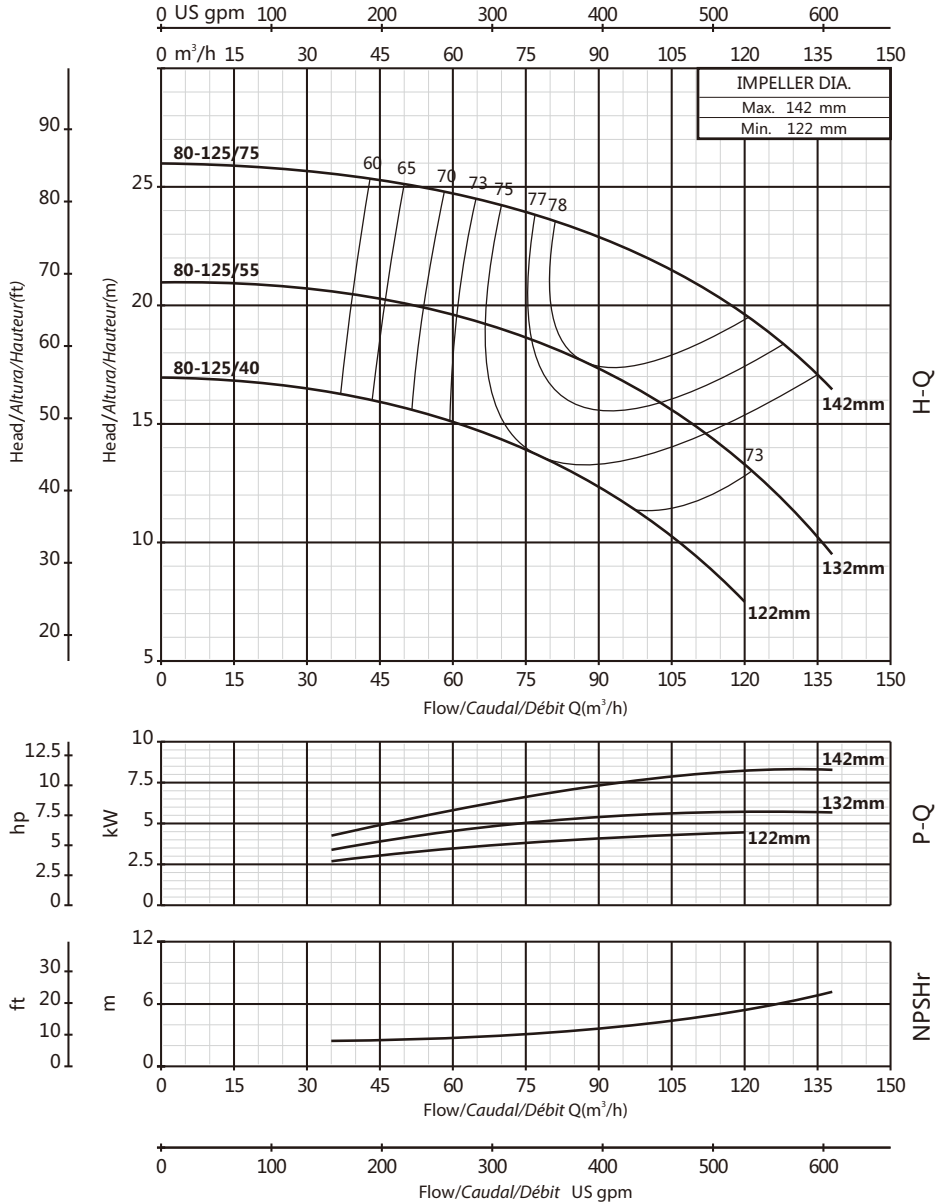

80-160

2900rpm

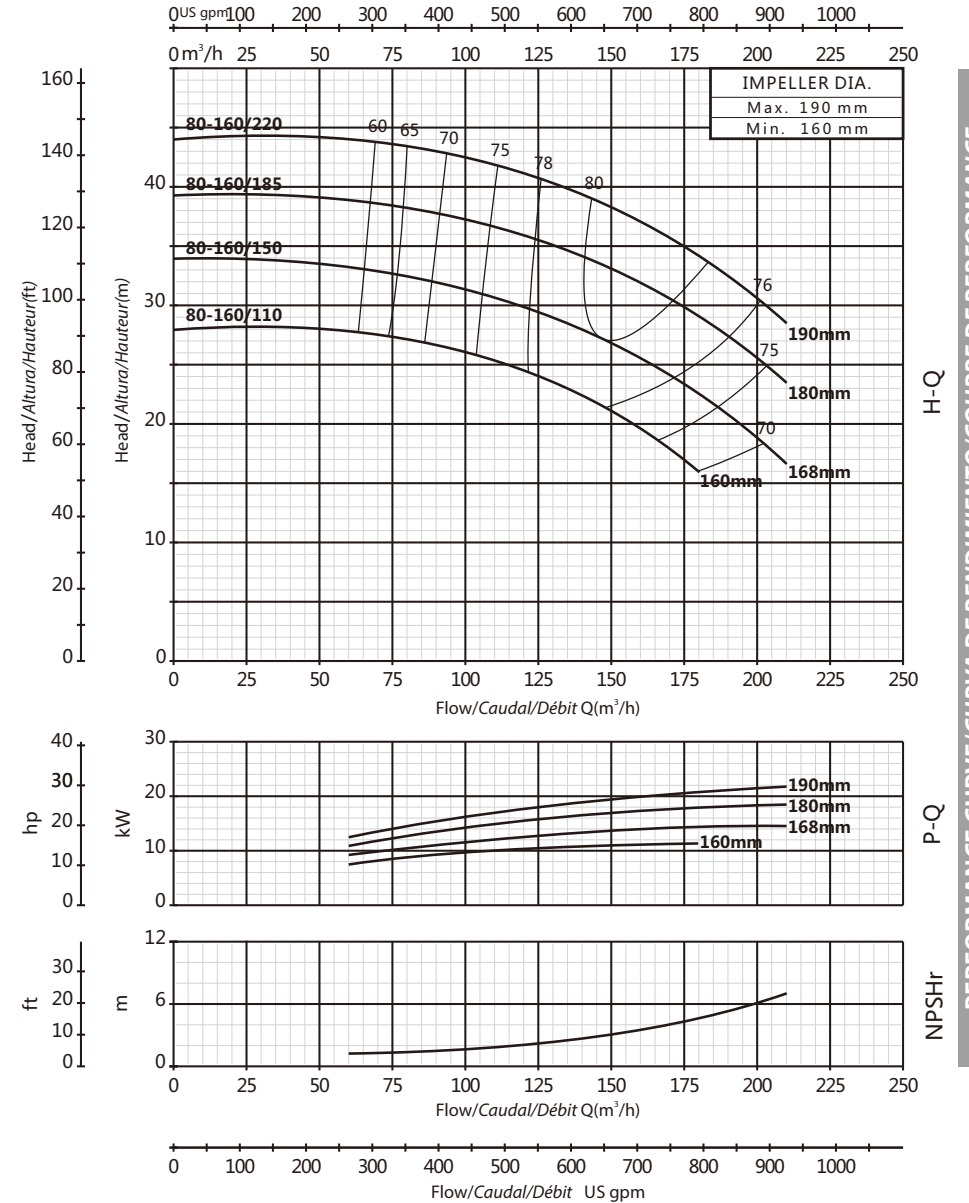

PERFORMANCE CURVE/CURVA DE RENDIMIENTO/COURBE DE PERFORMANCE

PERFORMANCE CURVE/CURVA DE RENDIMIENTO/COURBE DE PERFORMANCE

80-200

2900rpm

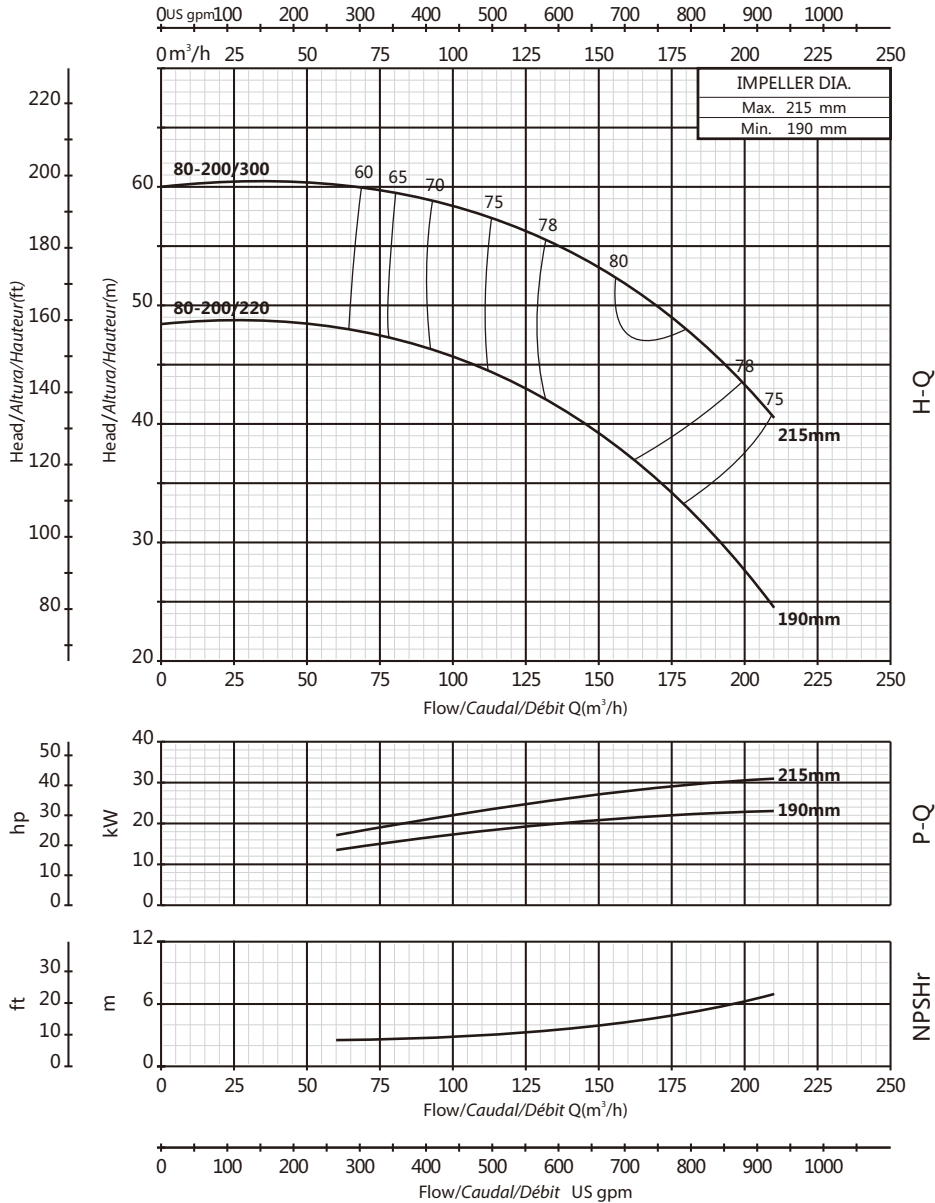

80-250

2900rpm

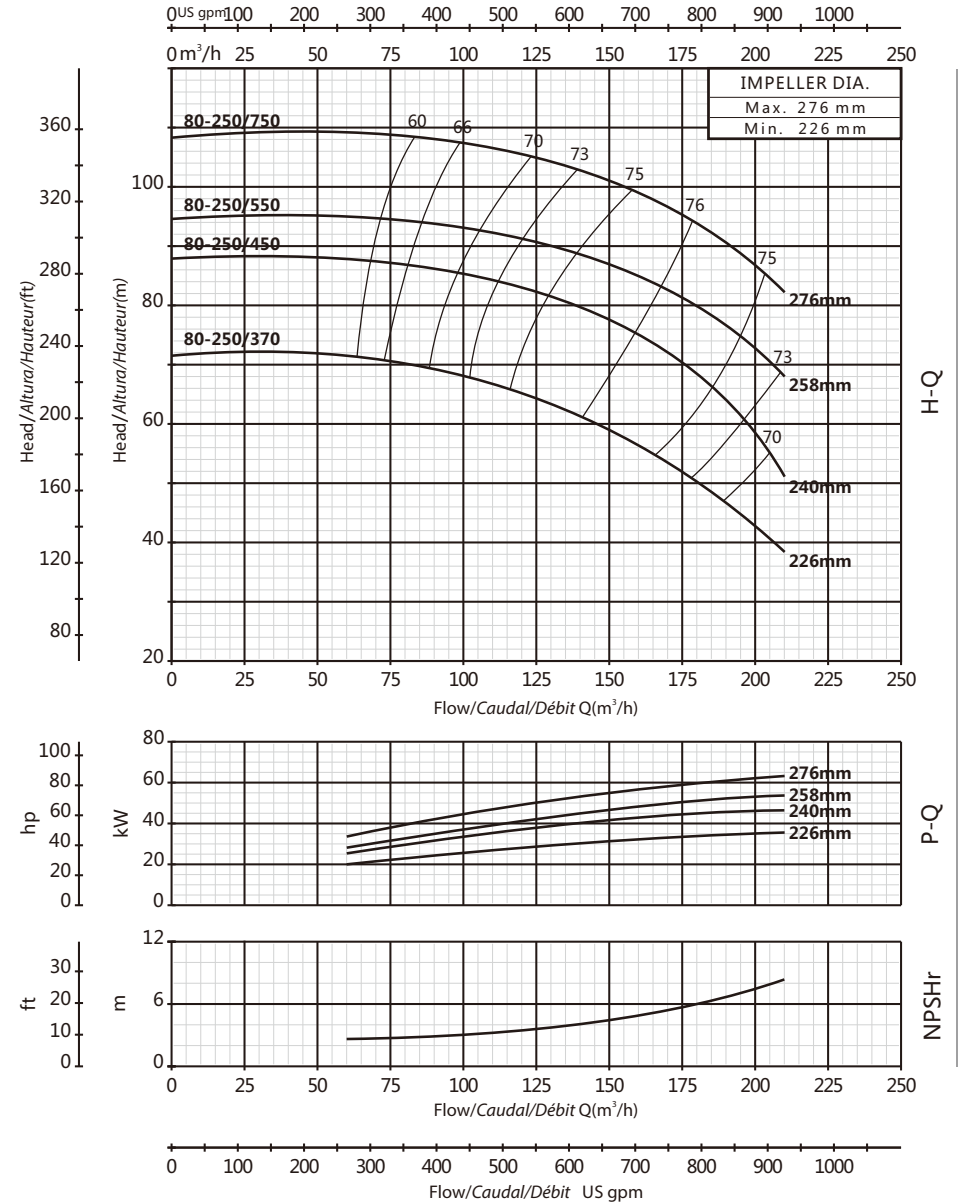

PERFORMANCE CURVE/CURVA DE RENDIMIENTO/COURBE DE PERFORMANCE

PERFORMANCE CURVE/CURVA DE RENDIMIENTO/COURBE DE PERFORMANCE

80-315

2900rpm

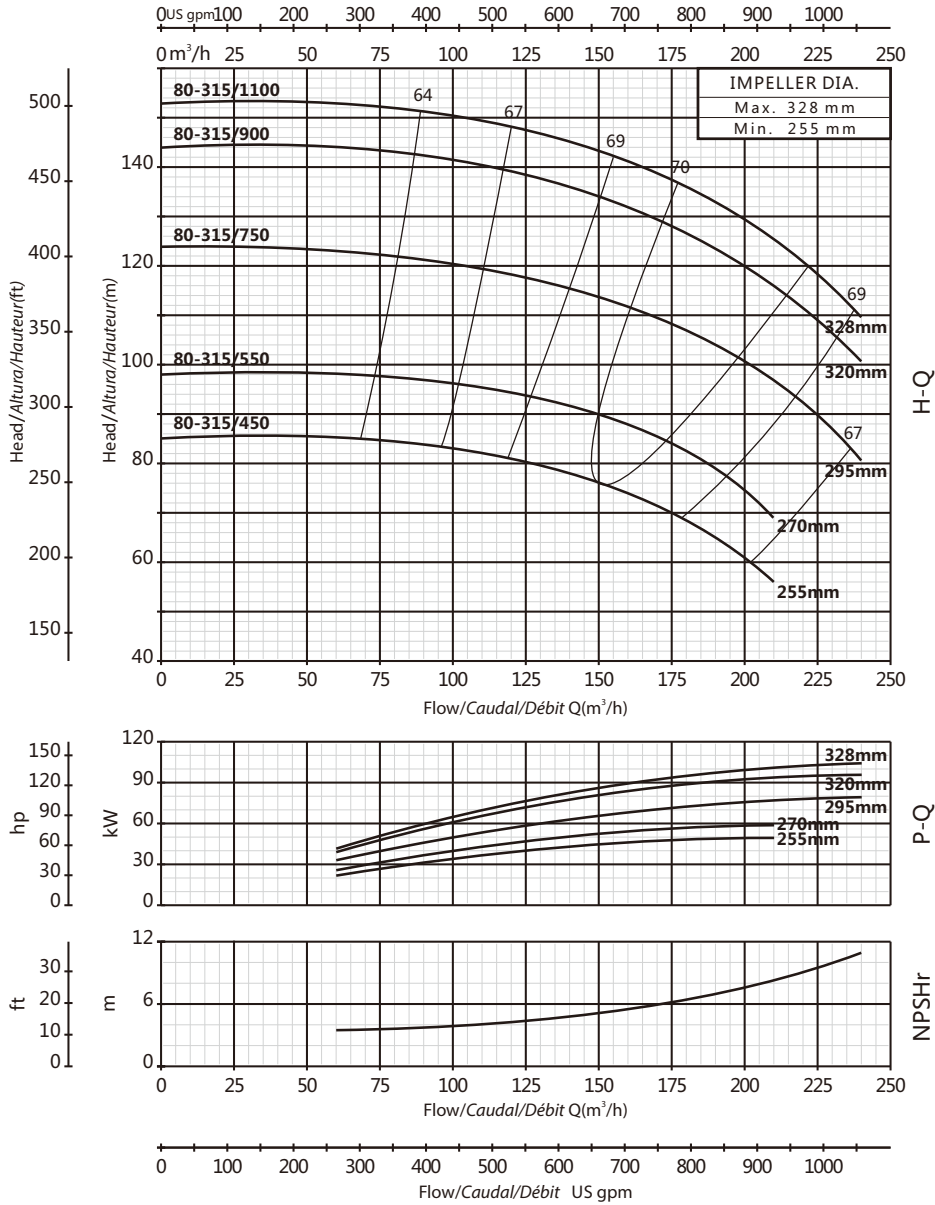

PERFORMANCE CURVE/CURVA DE RENDIMIENTO/COURBE DE PERFORMANCE

100-160

2900rpm

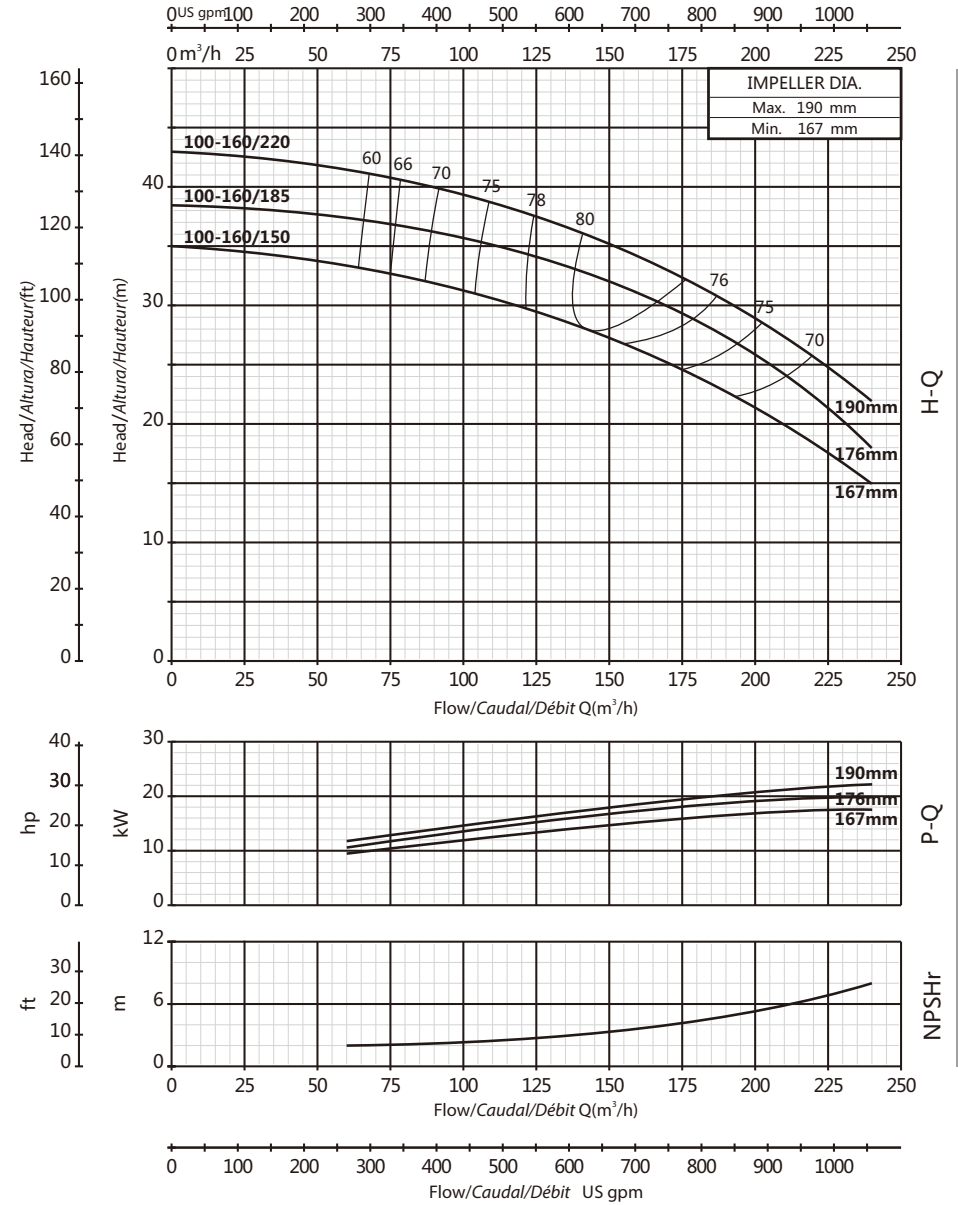

PERFORMANCE CURVE/CURVA DE RENDIMIENTO/COURBE DE PERFORMANCE

100-200

2900rpm

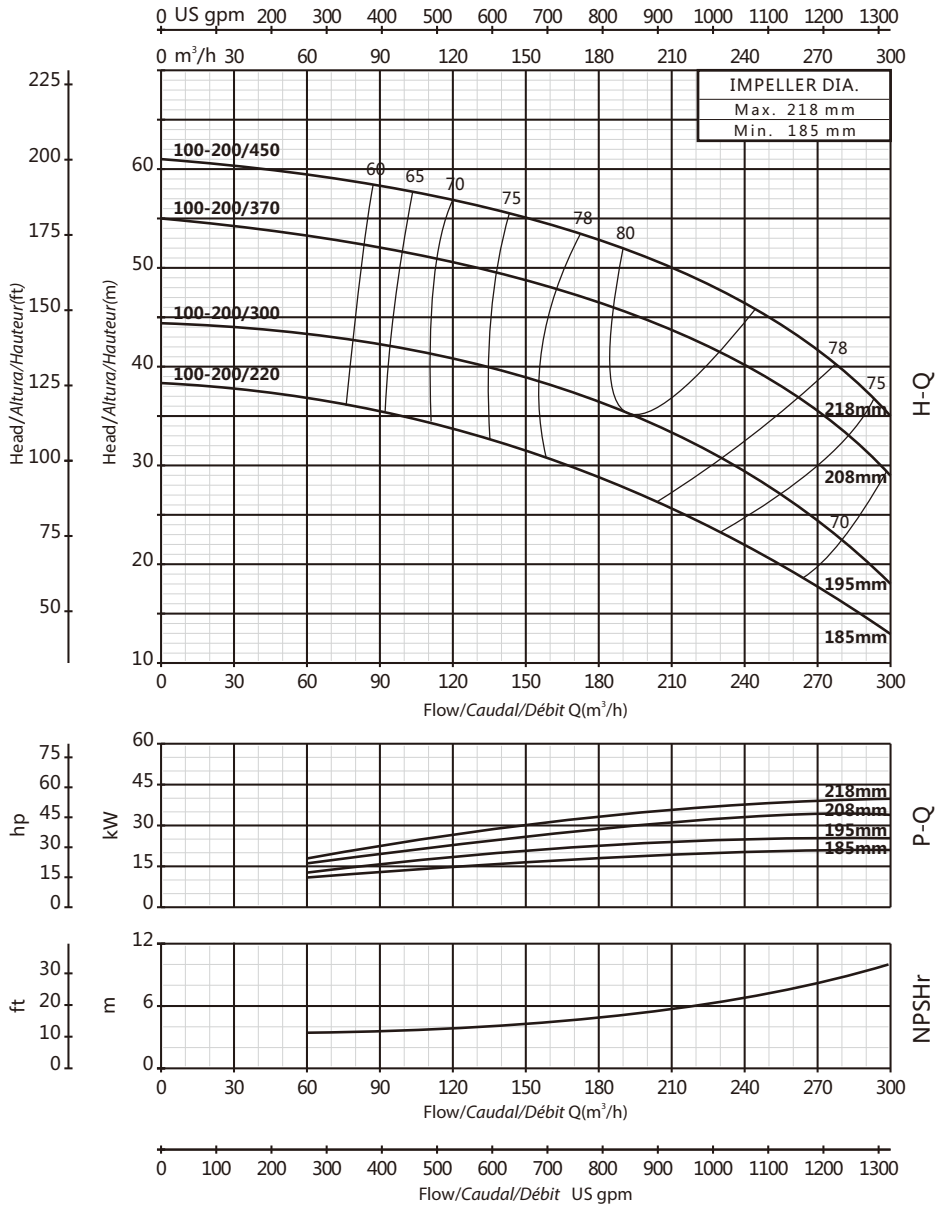

100-250

2900rpm

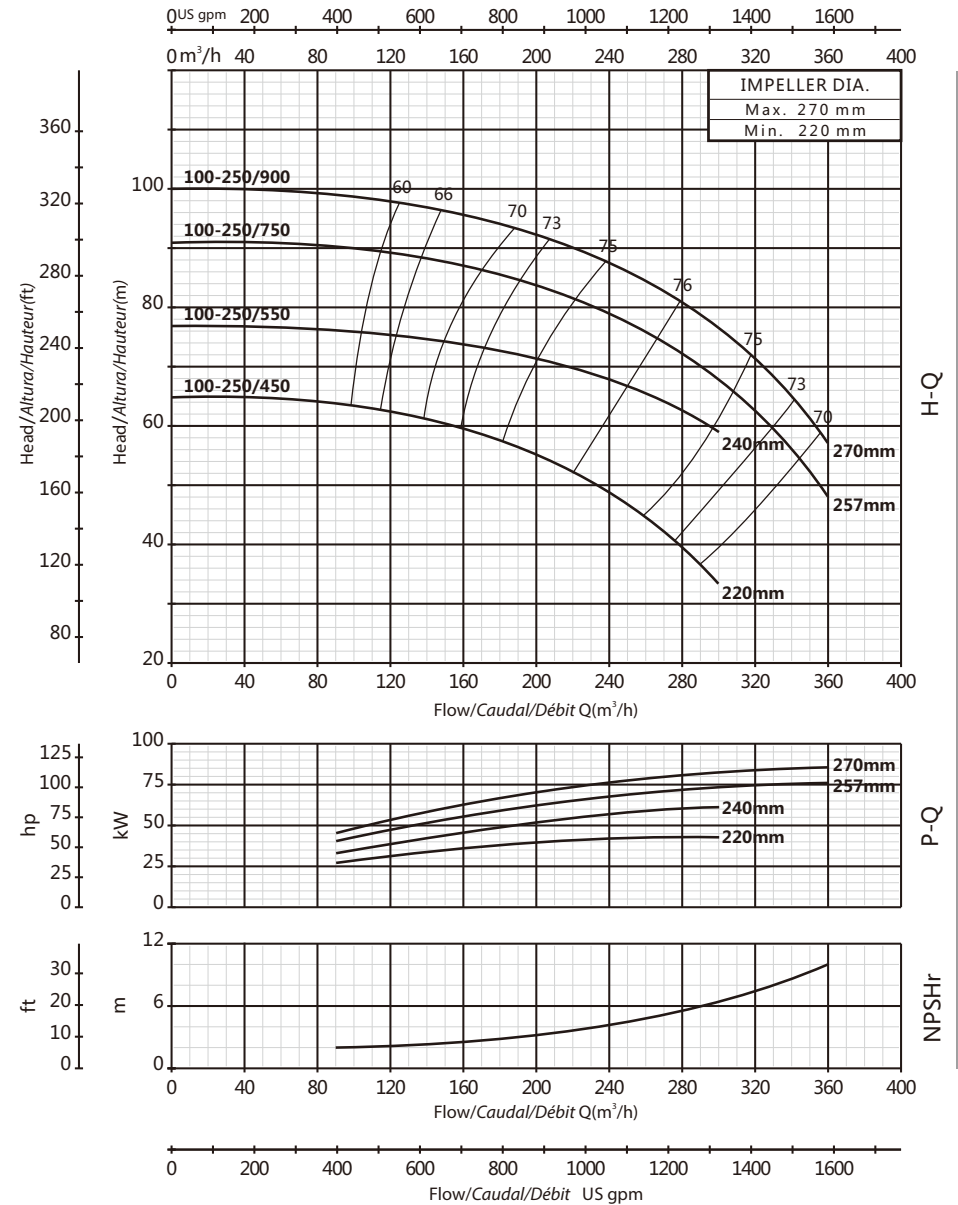

PERFORMANCE CURVE/CURVA DE RENDIMIENTO/COURBE DE PERFORMANCE

PERFORMANCE CURVE/CURVA DE RENDIMIENTO/COURBE DE PERFORMANCE

100-315

2900rpm

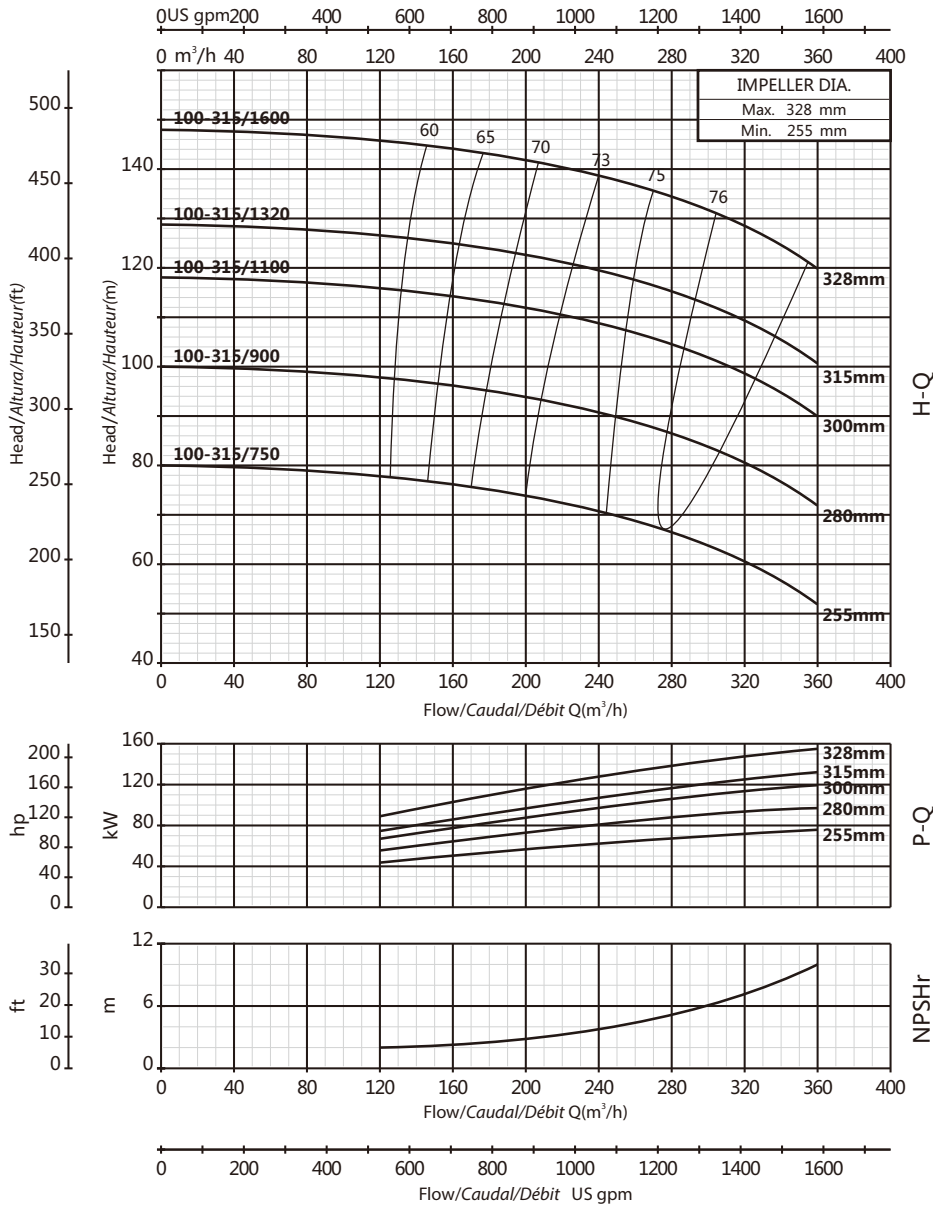

PERFORMANCE CURVE/CURVA DE RENDIMIENTO/COURBE DE PERFORMANCE

125-200

2900rpm

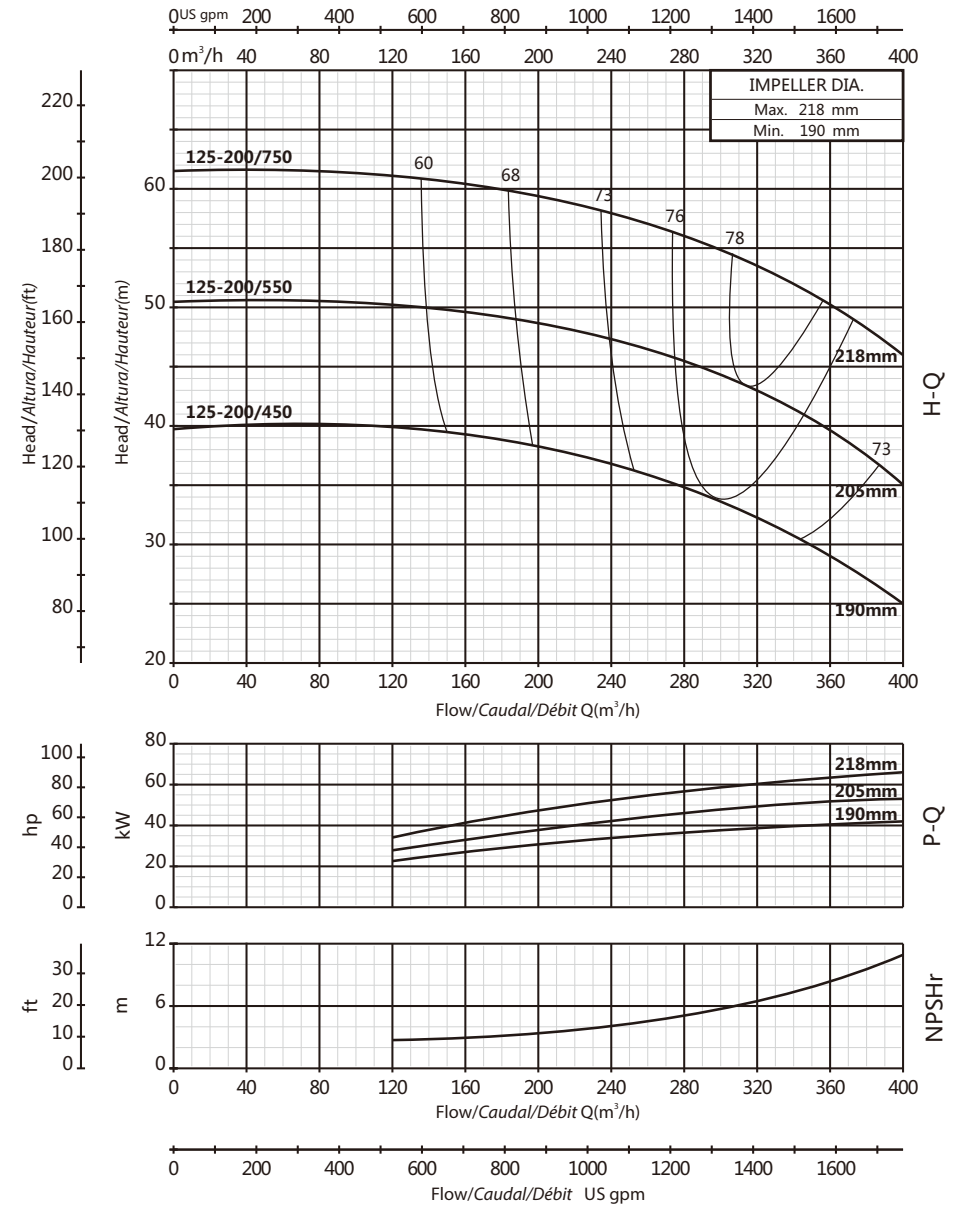

PERFORMANCE CURVE/CURVA DE RENDIMIENTO/COURBE DE PERFORMANCE

125-250

2900rpm

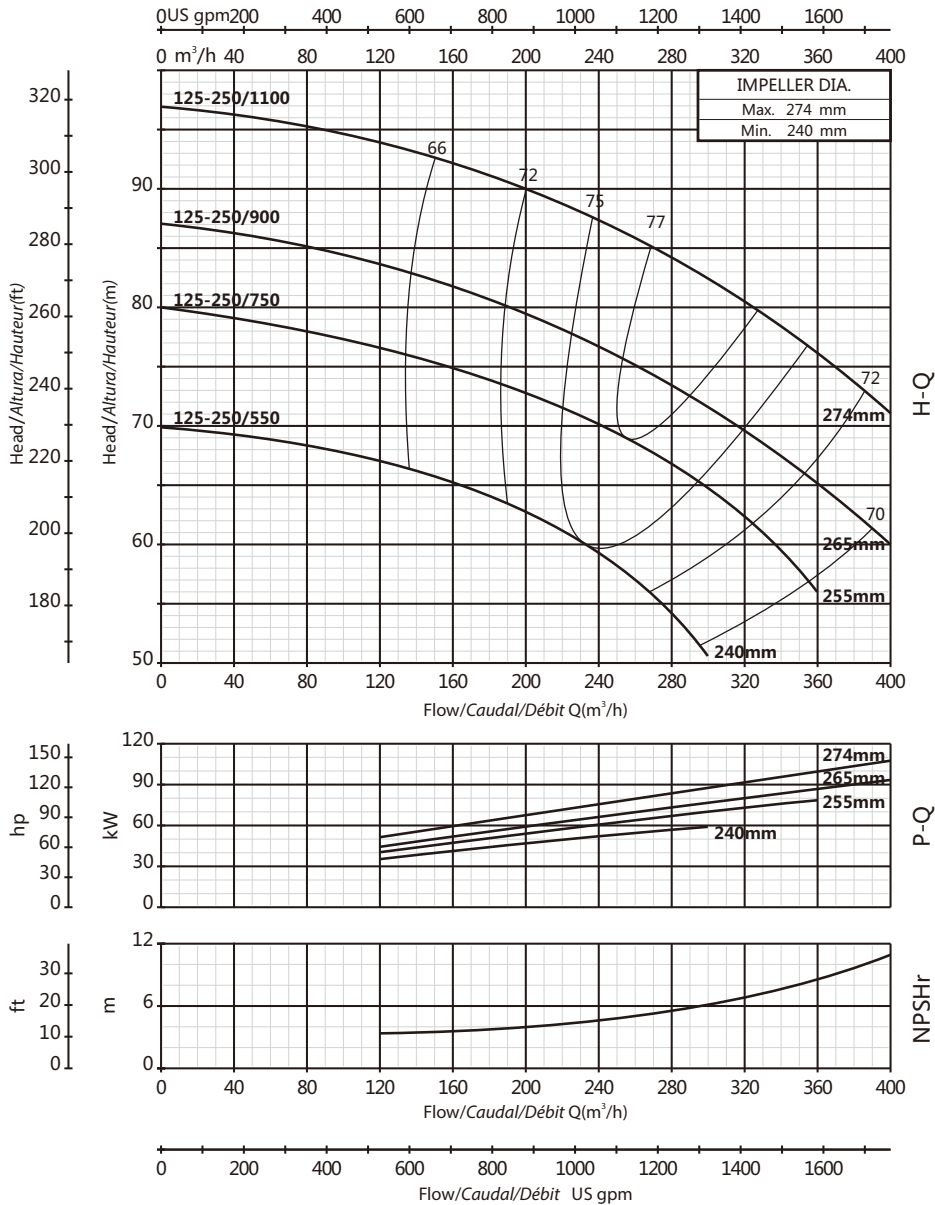

125-250H

2900rpm

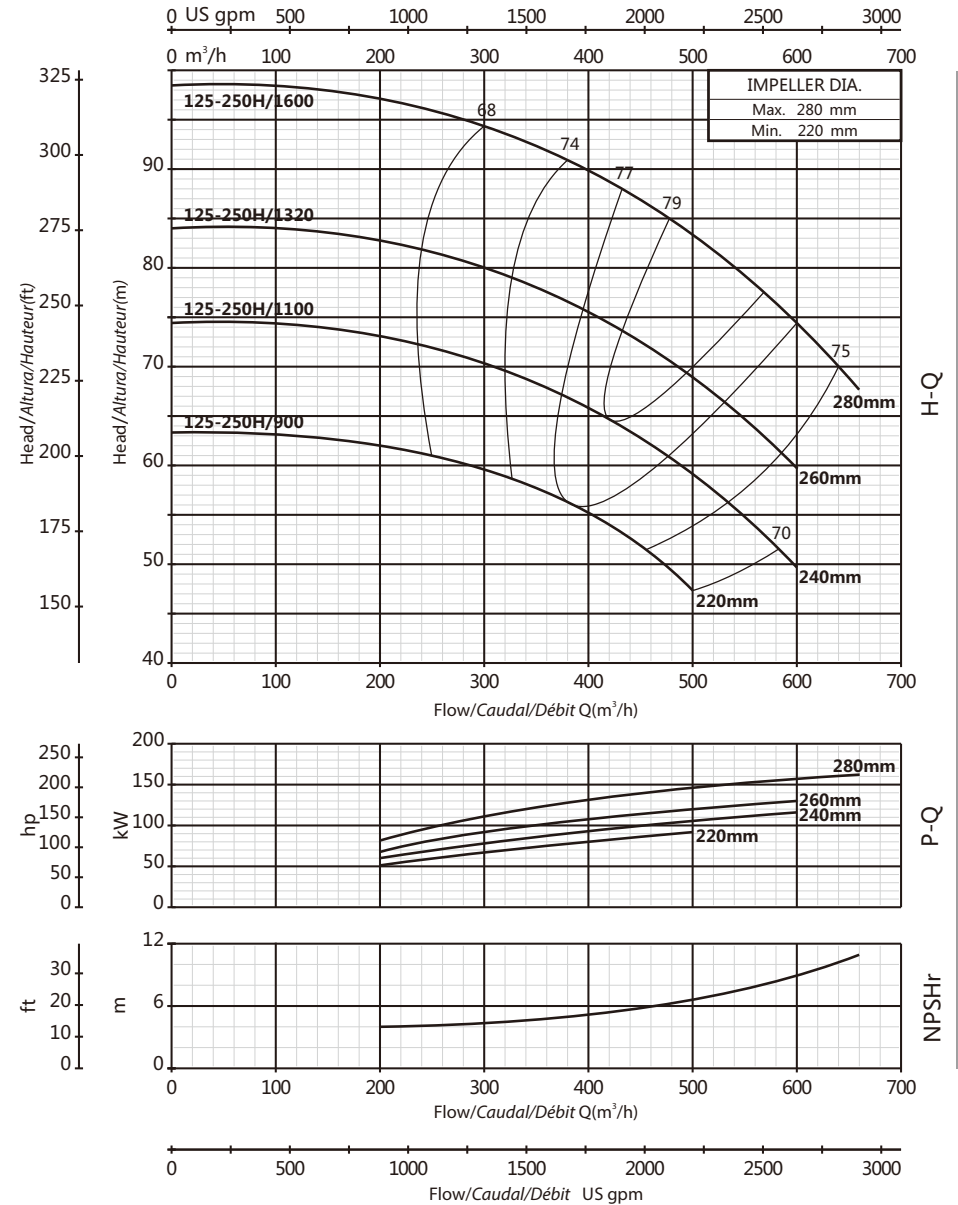

PERFORMANCE CURVE/CURVA DE RENDIMIENTO/COURBE DE PERFORMANCE

PERFORMANCE CURVE/CURVA DE RENDIMIENTO/COURBE DE PERFORMANCE

125-315

2900rpm

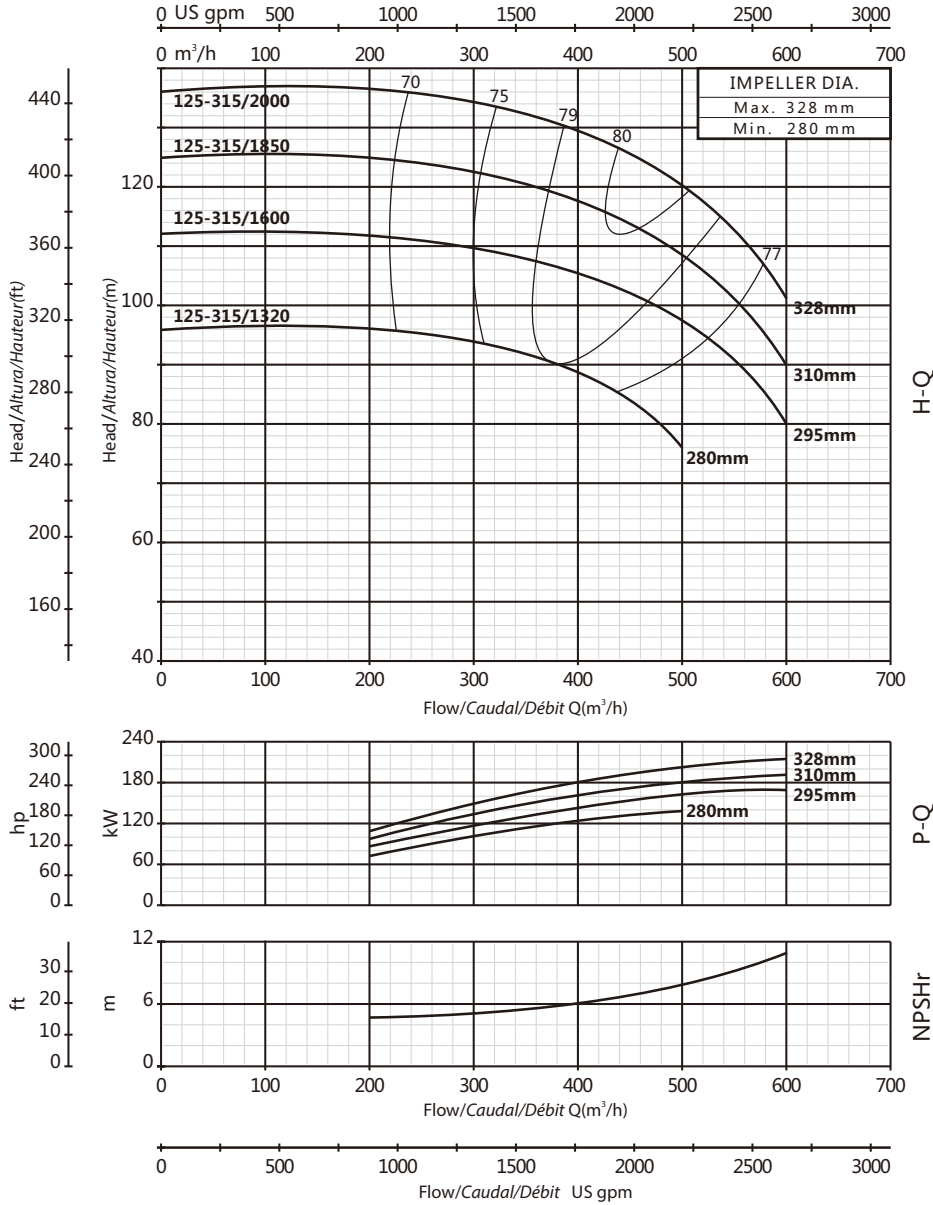

PERFORMANCE CURVE/CURVA DE RENDIMIENTO/COURBE DE PERFORMANCE

150-200

2900rpm

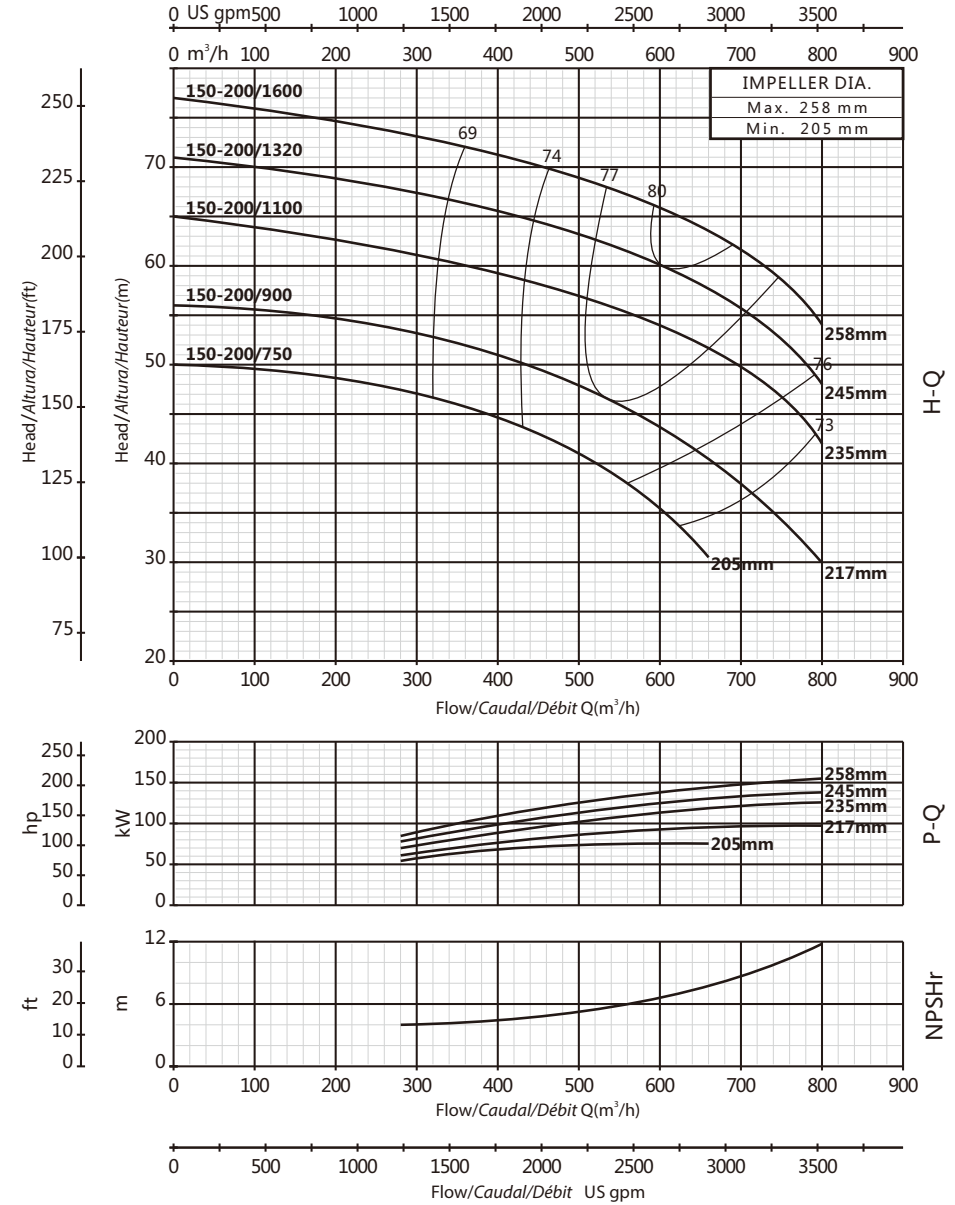

PERFORMANCE CURVE/CURVA DE RENDIMIENTO/COURBE DE PERFORMANCE

150-250

2900rpm

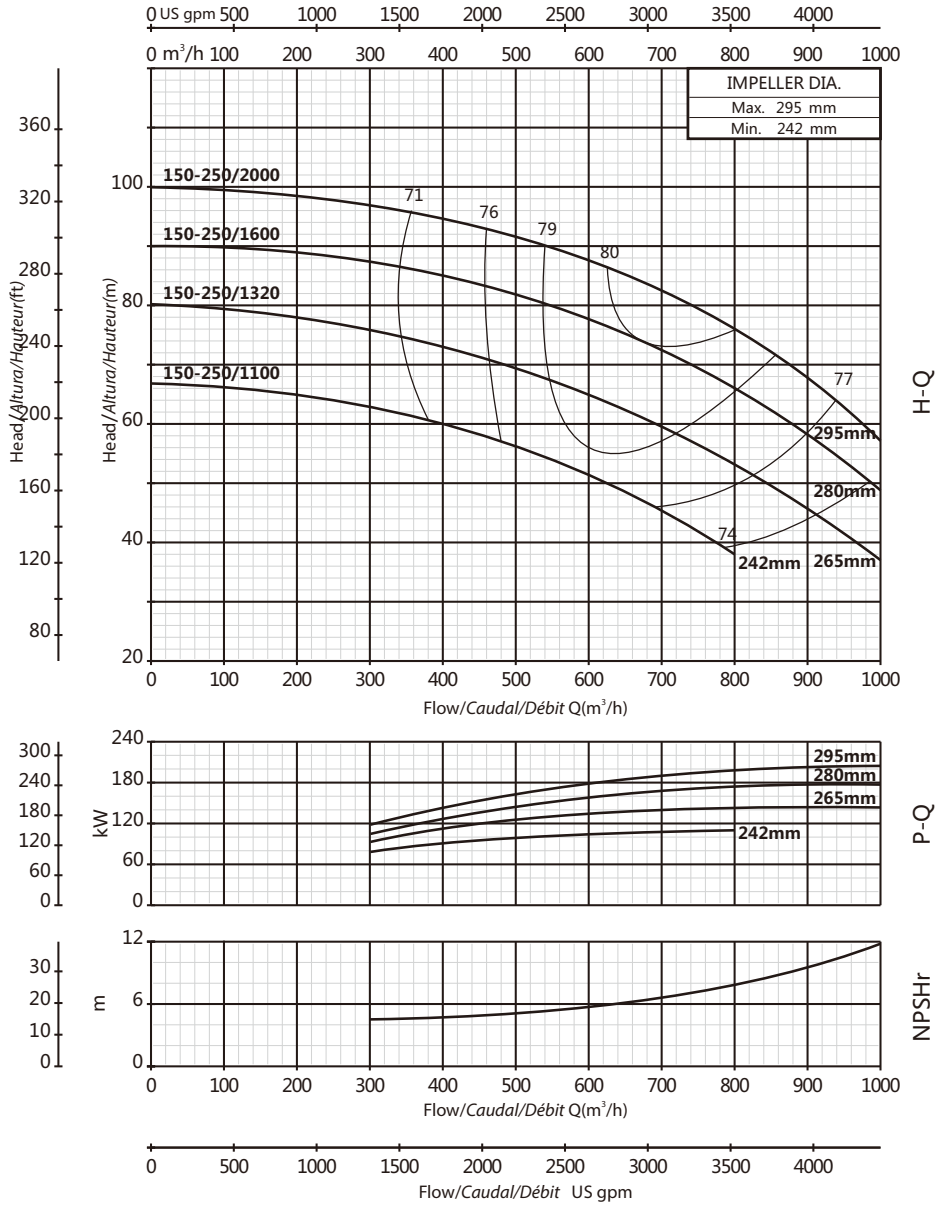

PERFORMANCE CURVE/CURVA DE RENDIMIENTO/COURBE DE PERFORMANCE

150-315

2900rpm

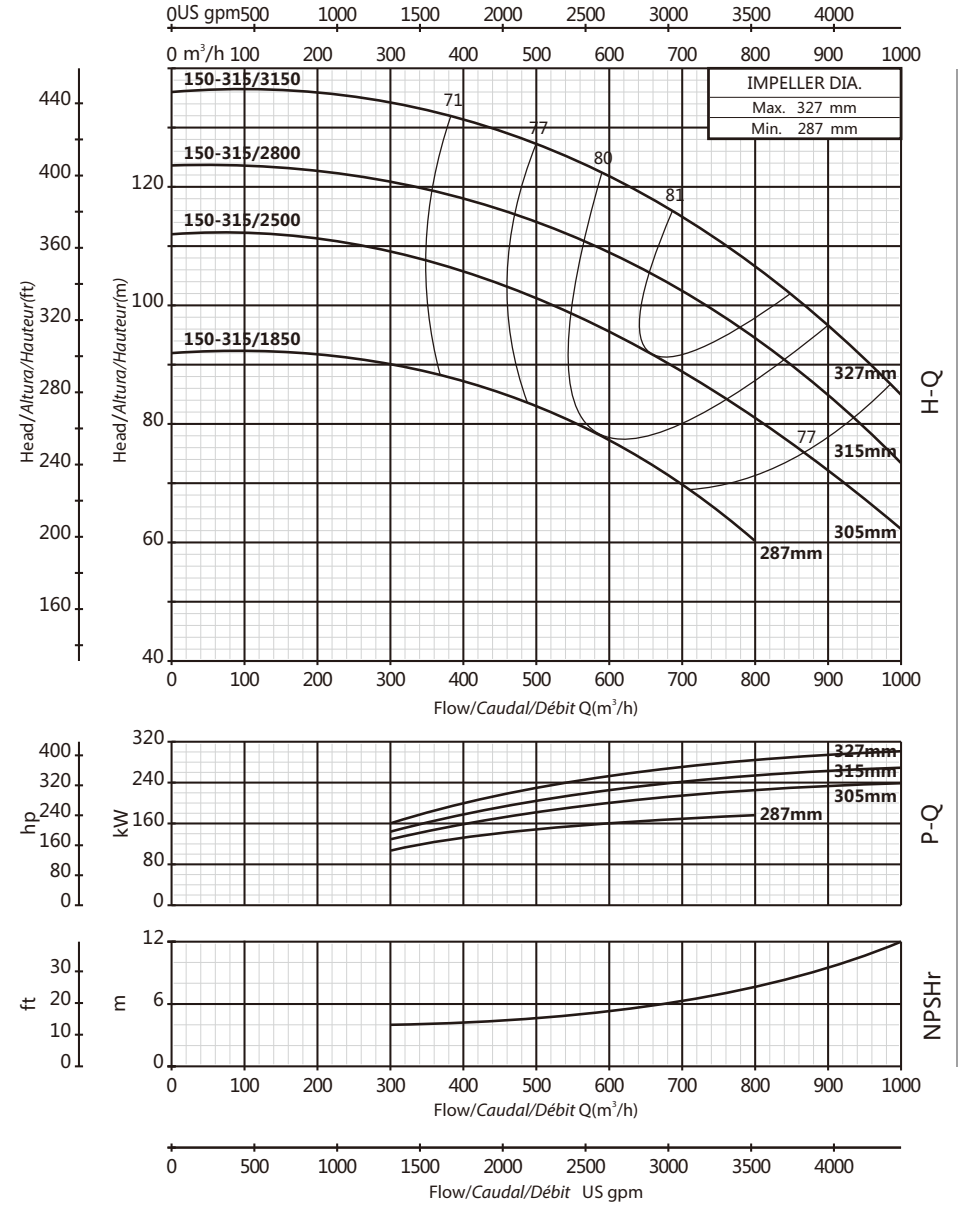

PERFORMANCE CURVE/CURVA DE RENDIMIENTO/COURBE DE PERFORMANCE

65-160

1450rpm

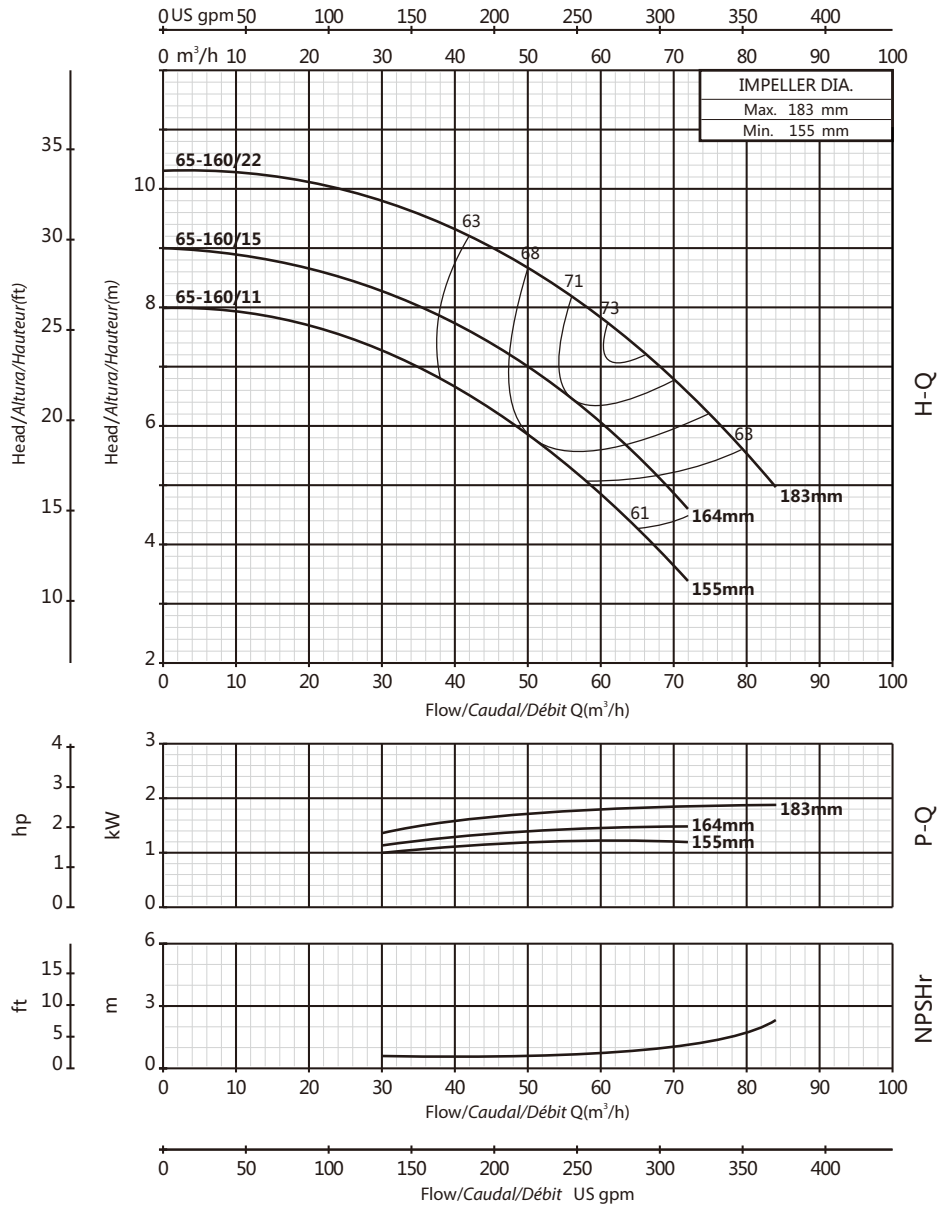

PERFORMANCE CURVE/CURVA DE RENDIMIENTO/COURBE DE PERFORMANCE

65-200

1450rpm

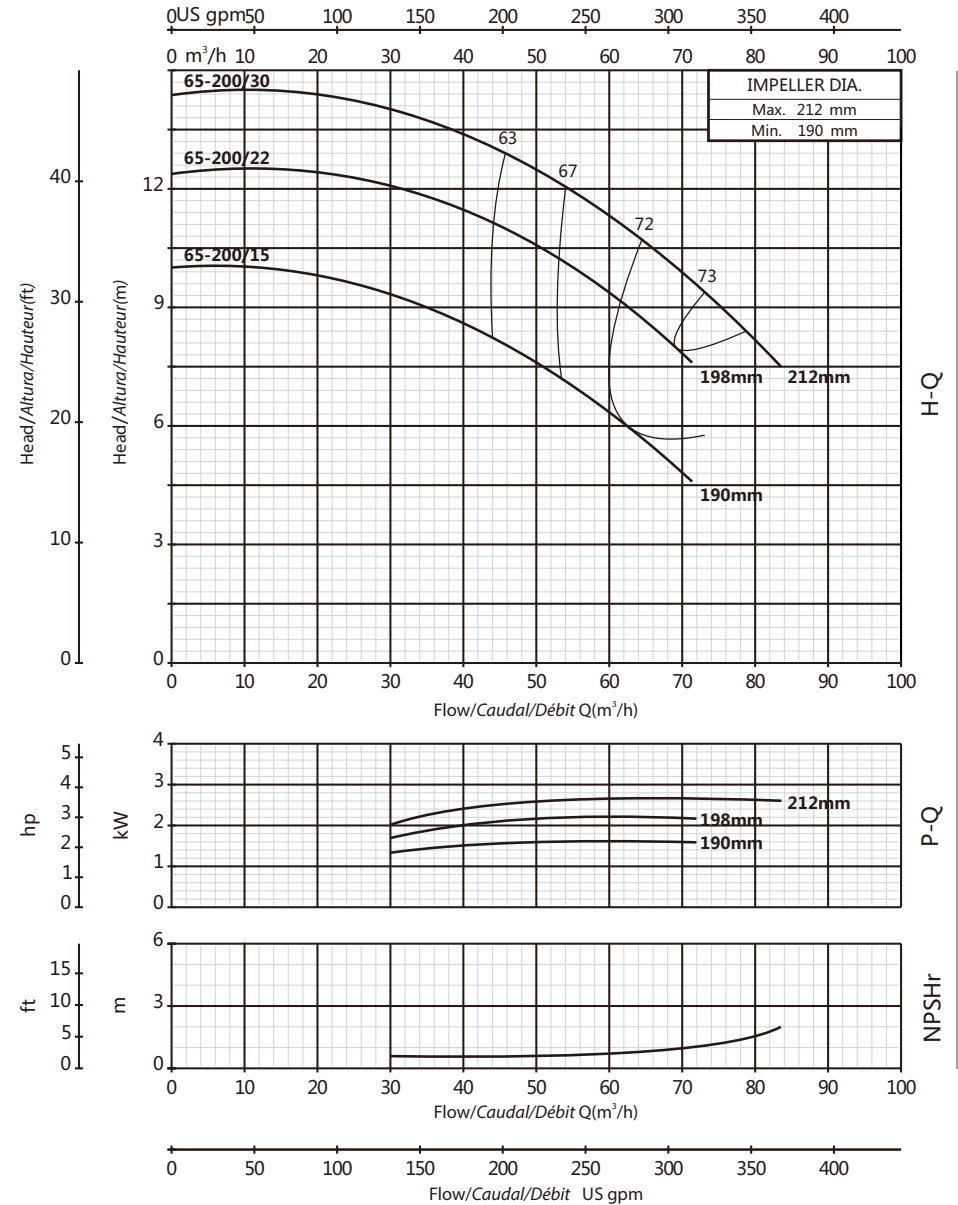

PERFORMANCE CURVE/CURVA DE RENDIMIENTO/COURBE DE PERFORMANCE

65-250

1450rpm

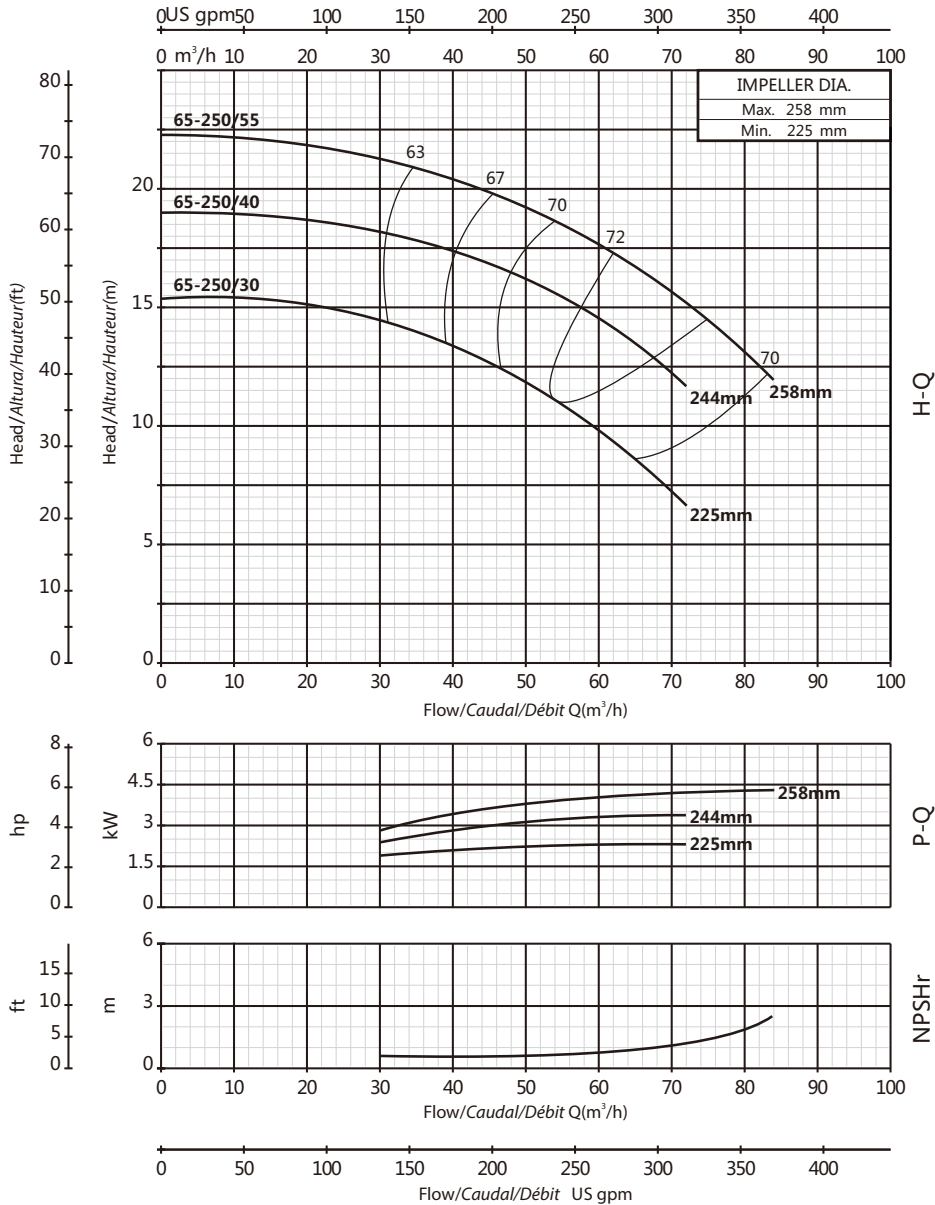

65-315

1450rpm

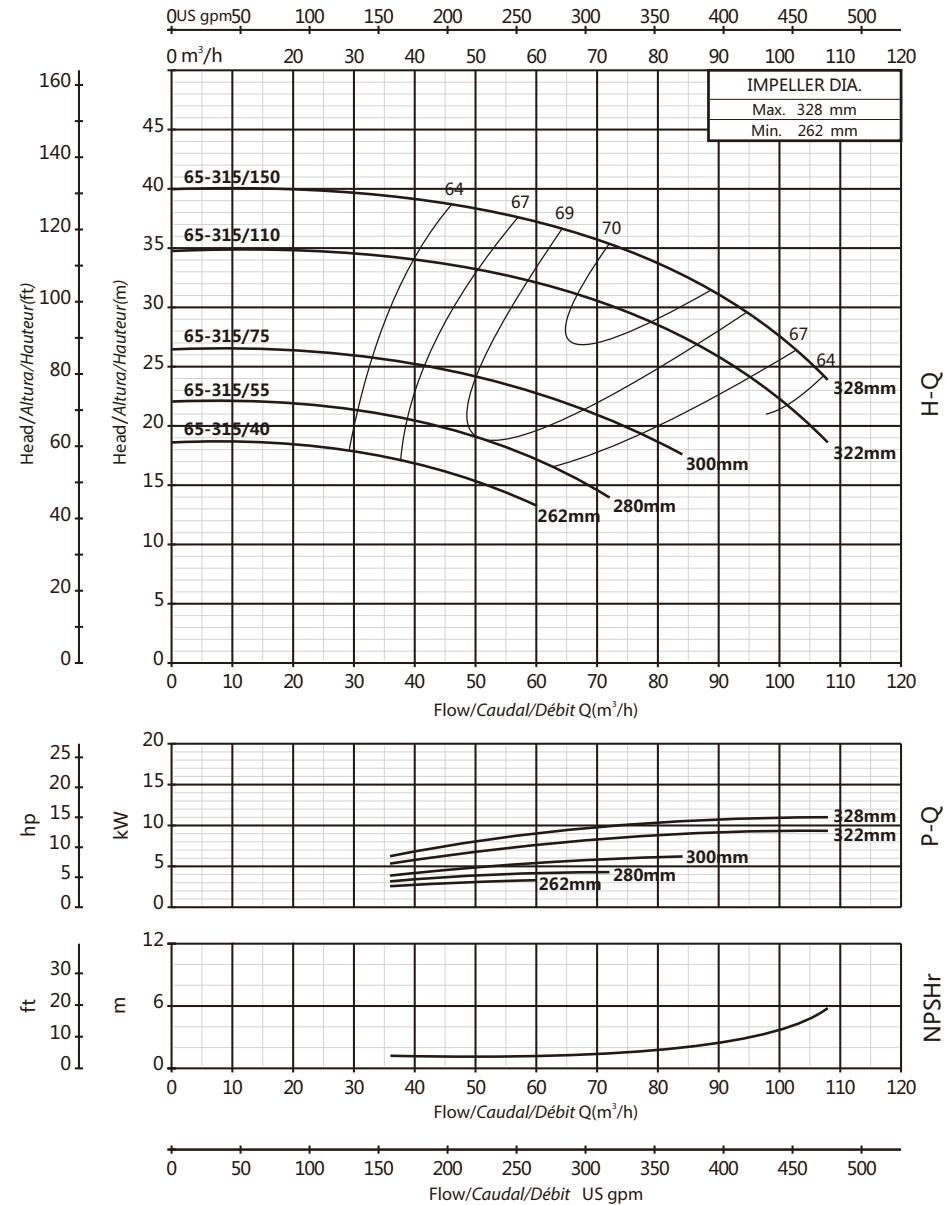

PERFORMANCE CURVE/CURVA DE RENDIMIENTO/COURBE DE PERFORMANCE

PERFORMANCE CURVE/CURVA DE RENDIMIENTO/COURBE DE PERFORMANCE

80-160

1450rpm

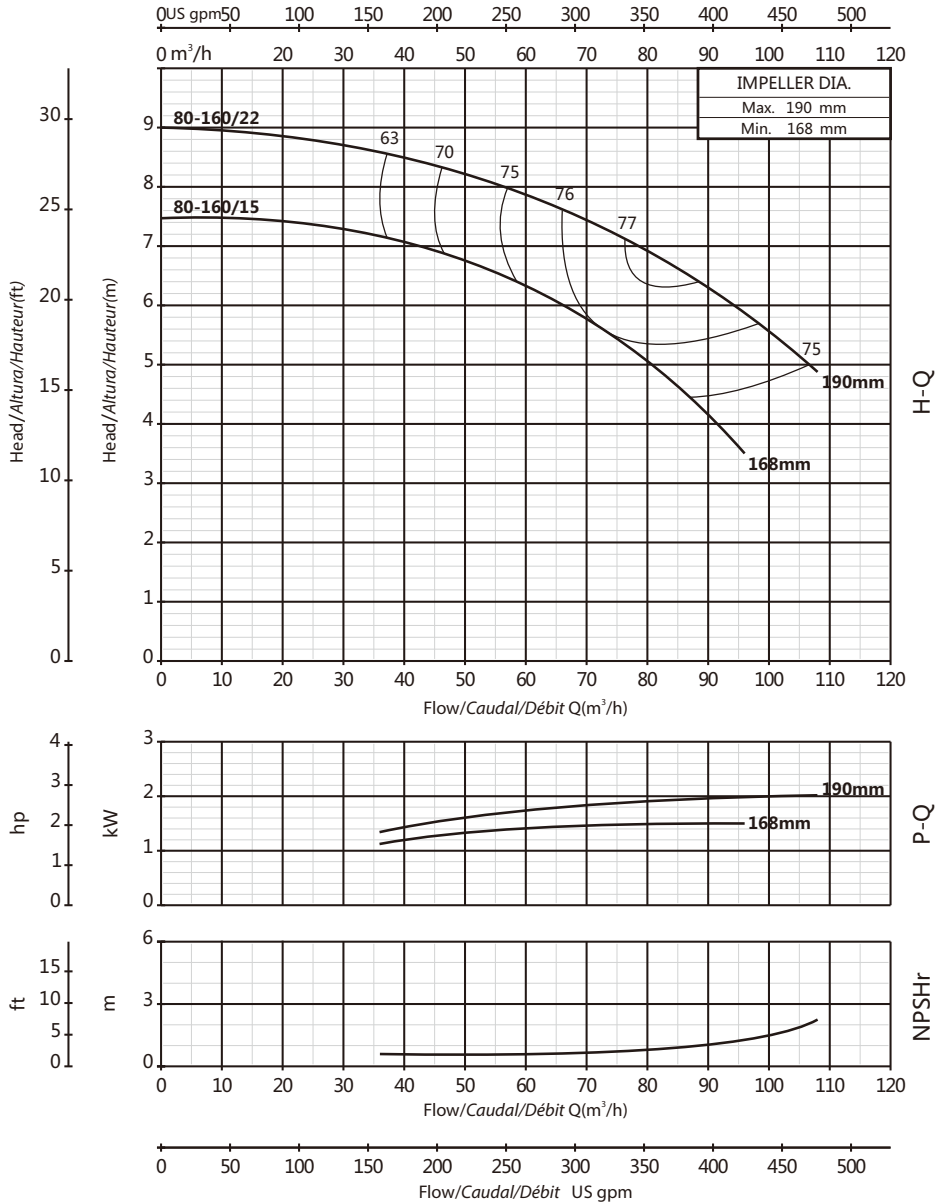

80-200

1450rpm

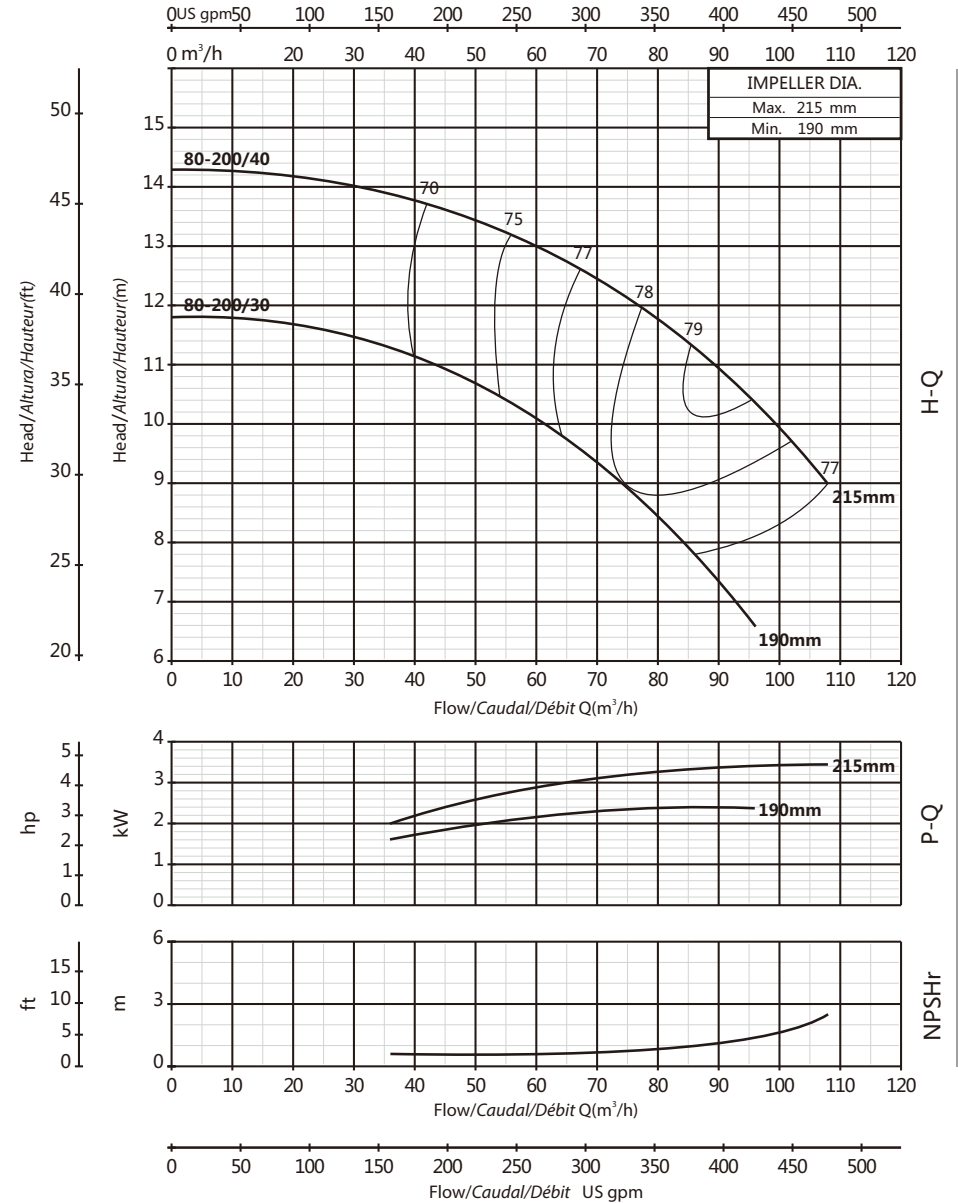

PERFORMANCE CURVE/CURVA DE RENDIMIENTO/COURBE DE PERFORMANCE

PERFORMANCE CURVE/CURVA DE RENDIMIENTO/COURBE DE PERFORMANCE

80-250

1450rpm

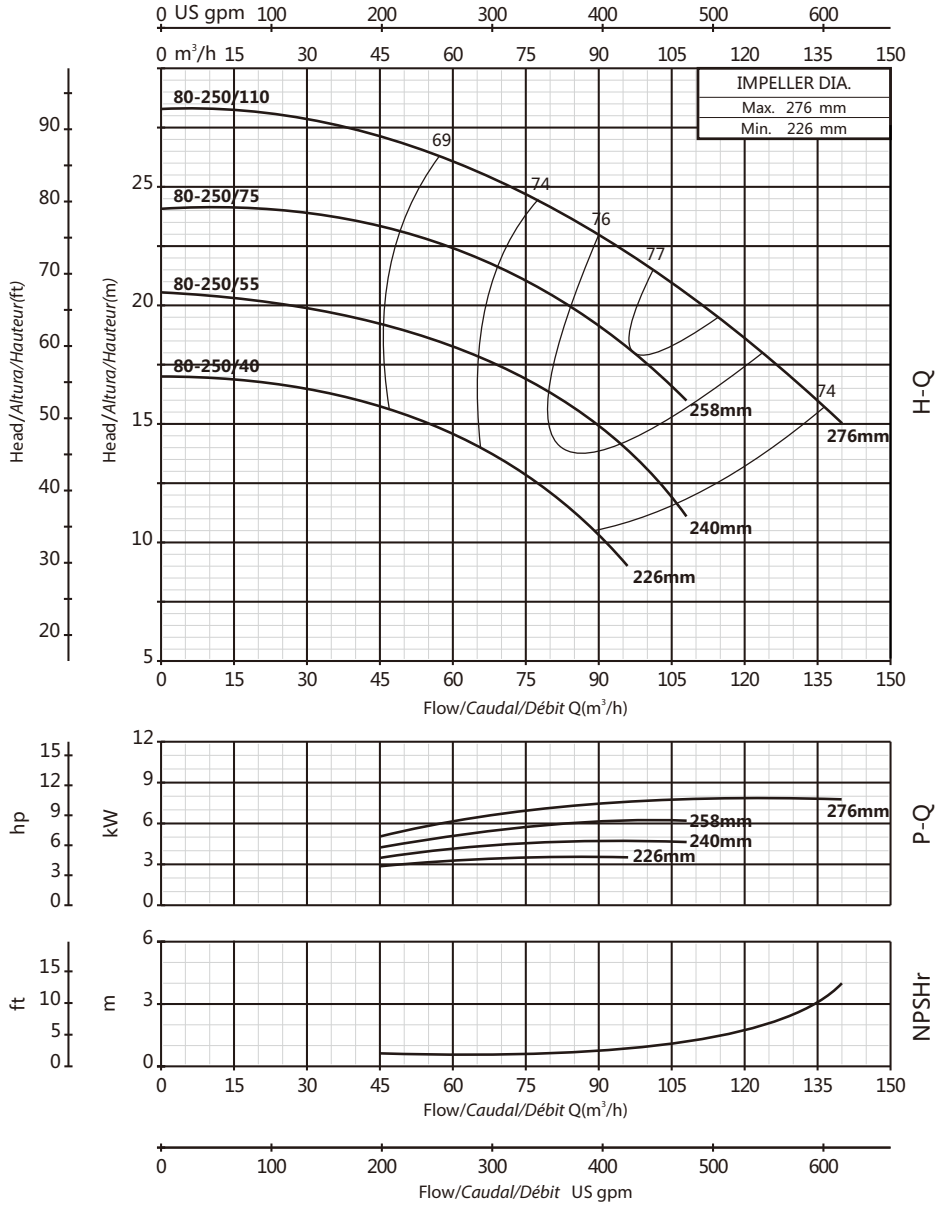

PERFORMANCE CURVE/CURVA DE RENDIMIENTO/COURBE DE PERFORMANCE

80-315

1450rpm

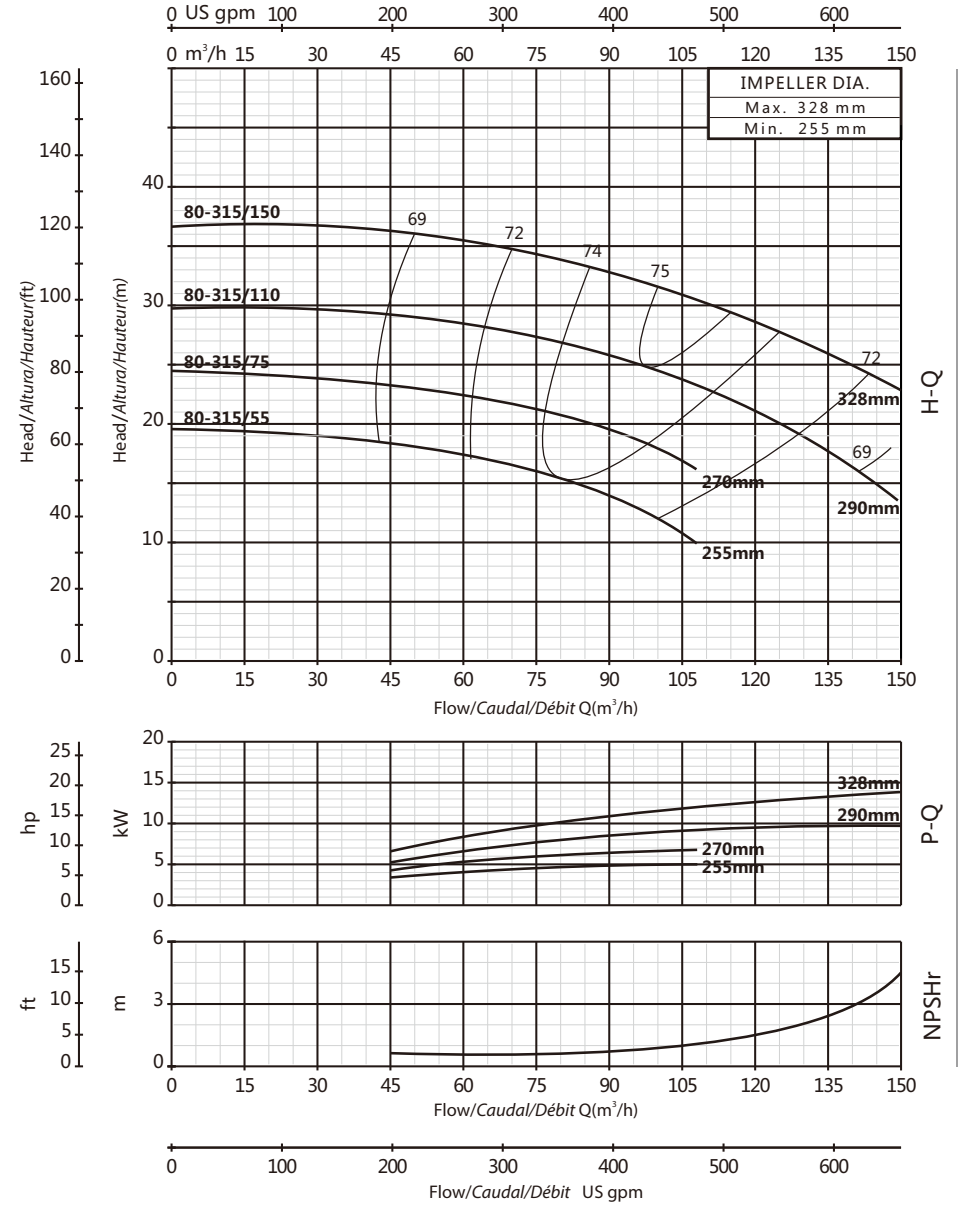

PERFORMANCE CURVE/CURVA DE RENDIMIENTO/COURBE DE PERFORMANCE

80-400

1450rpm

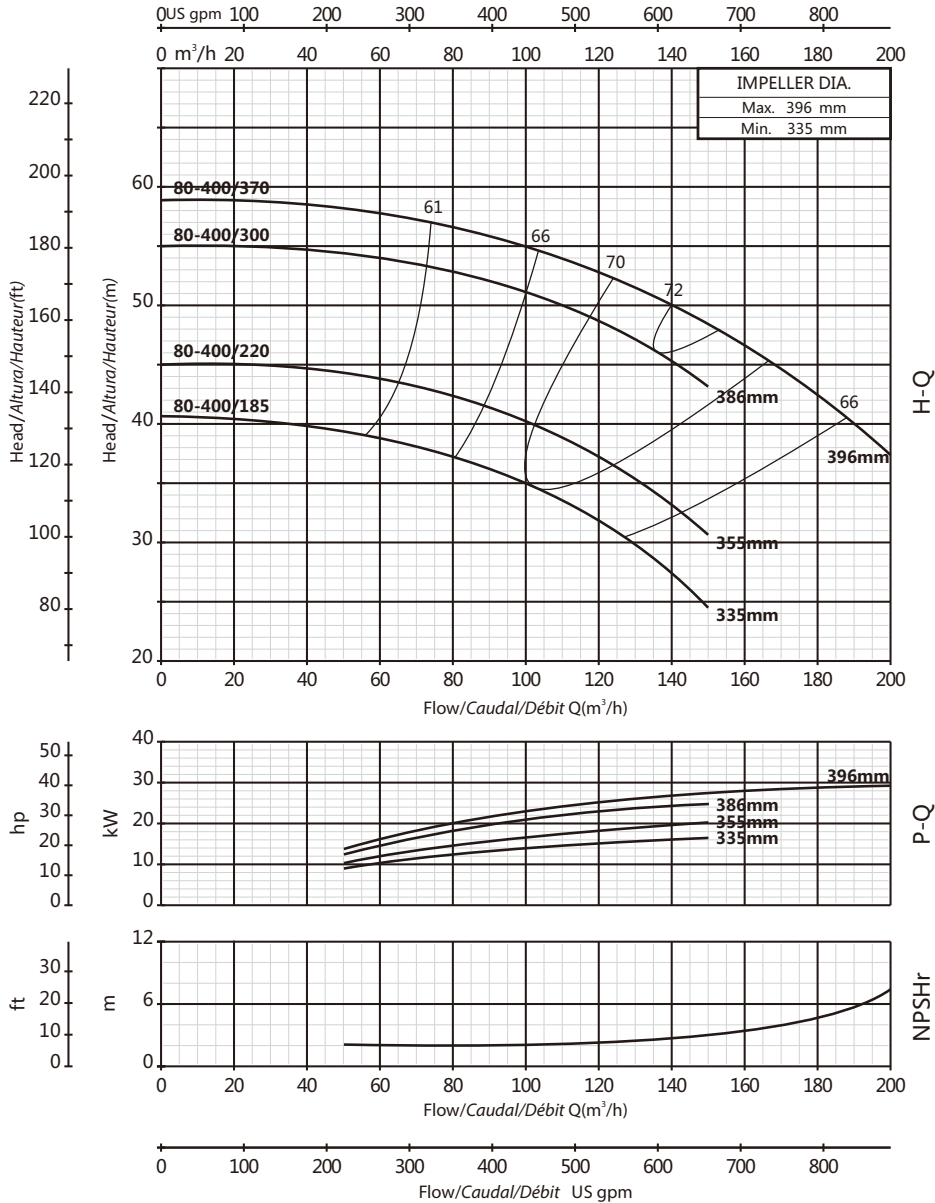

100-160

1450rpm

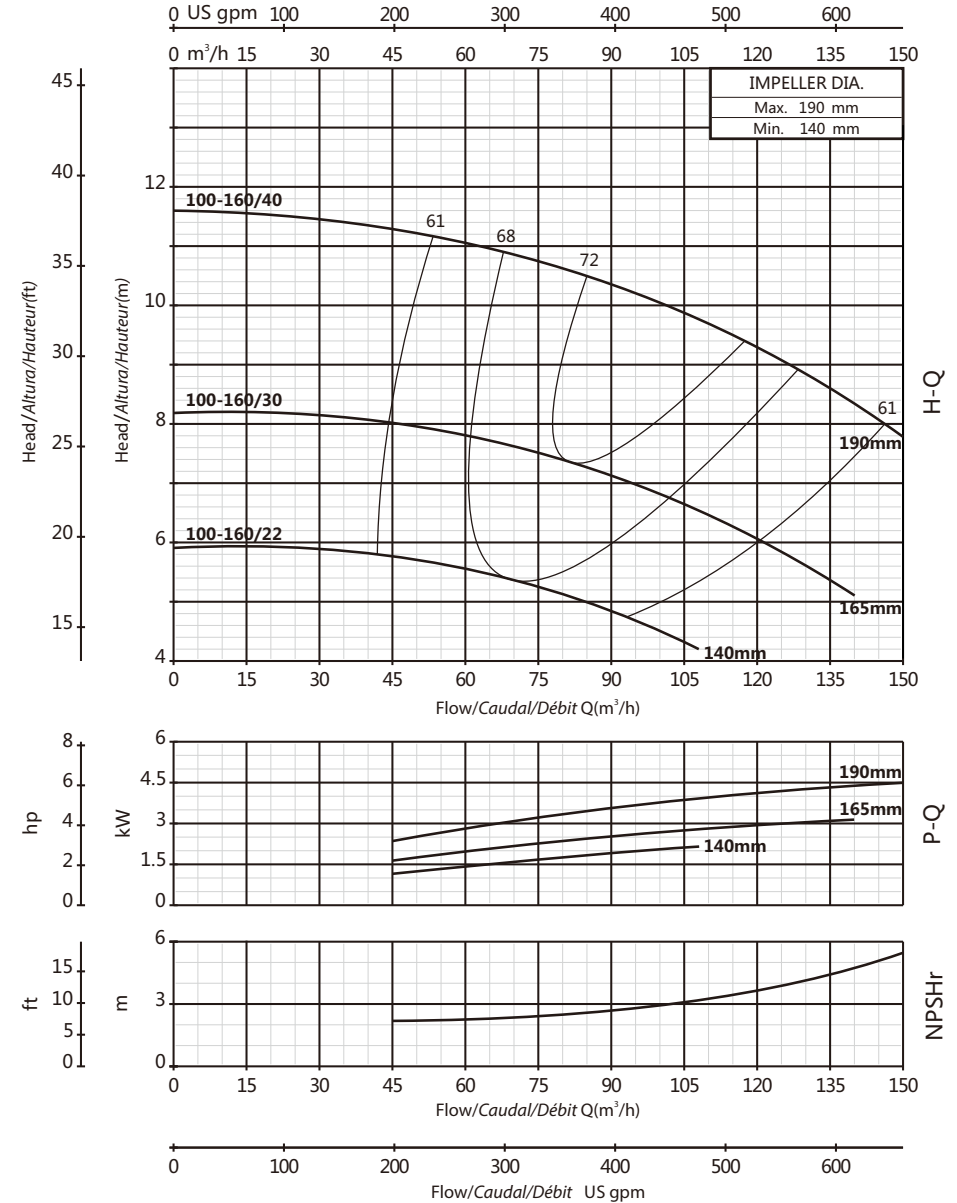

PERFORMANCE CURVE/CURVA DE RENDIMIENTO/COURBE DE PERFORMANCE

PERFORMANCE CURVE/CURVA DE RENDIMIENTO/COURBE DE PERFORMANCE

100-200

1450rpm

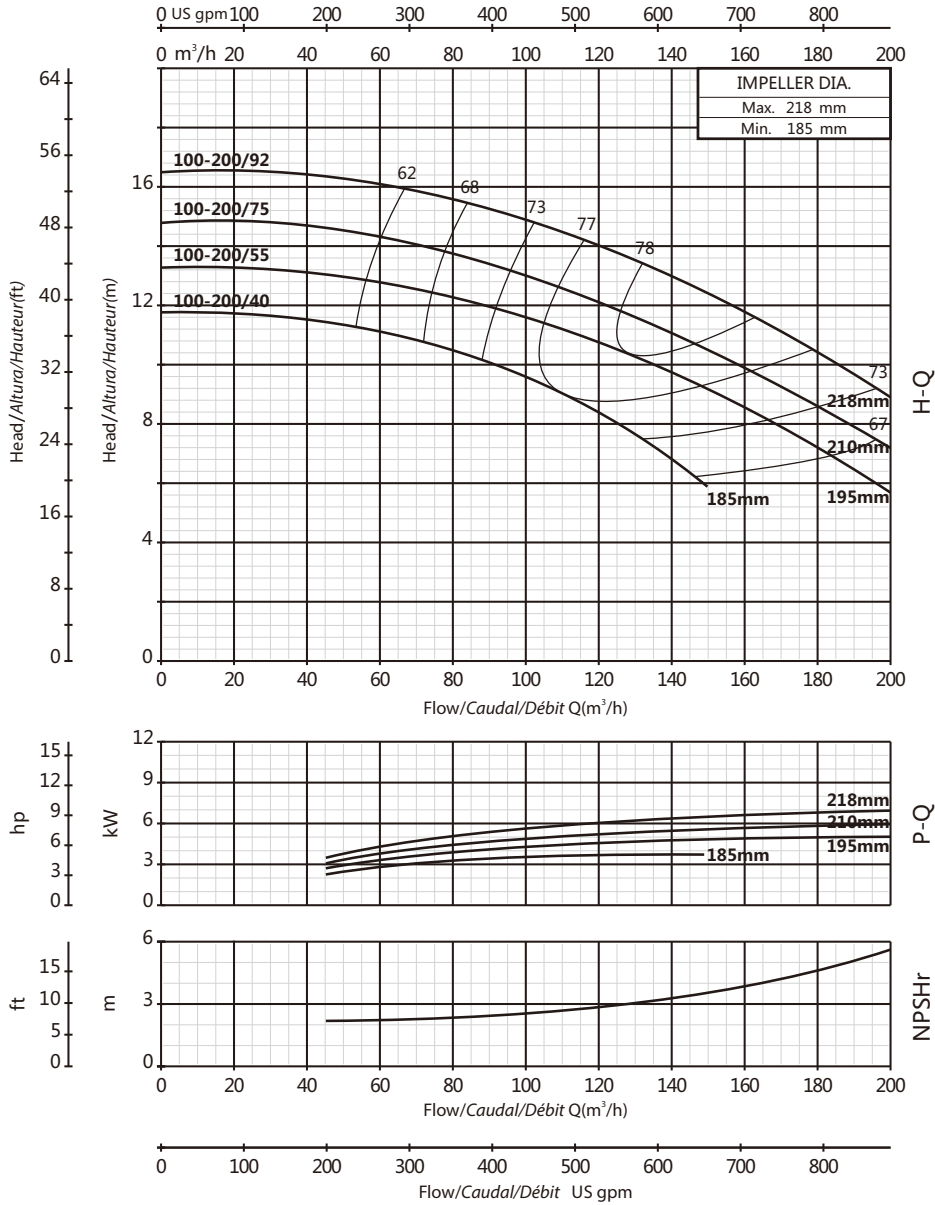

PERFORMANCE CURVE/CURVA DE RENDIMIENTO/COURBE DE PERFORMANCE

100-250

1450rpm

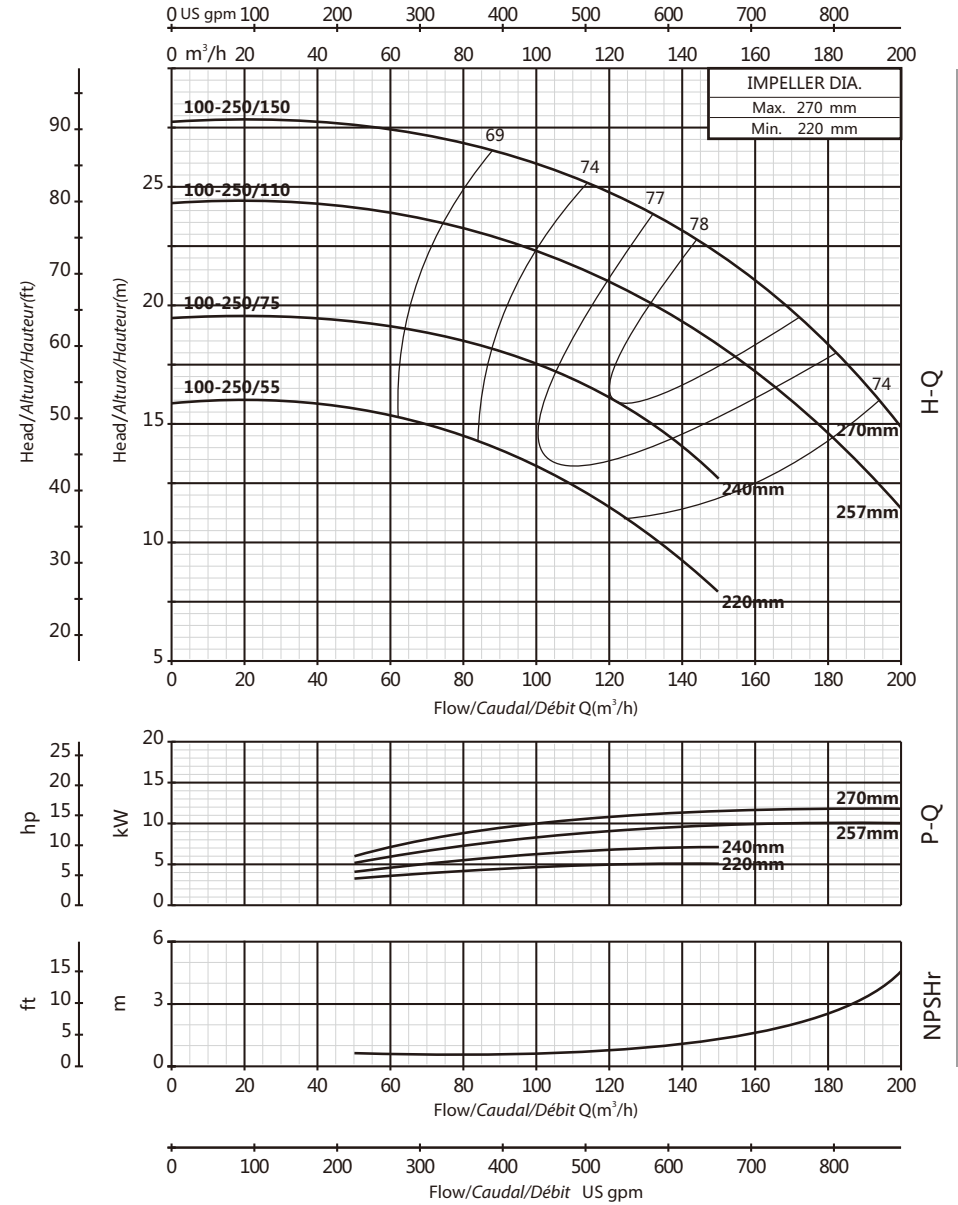

PERFORMANCE CURVE/CURVA DE RENDIMIENTO/COURBE DE PERFORMANCE

100-315

1450rpm

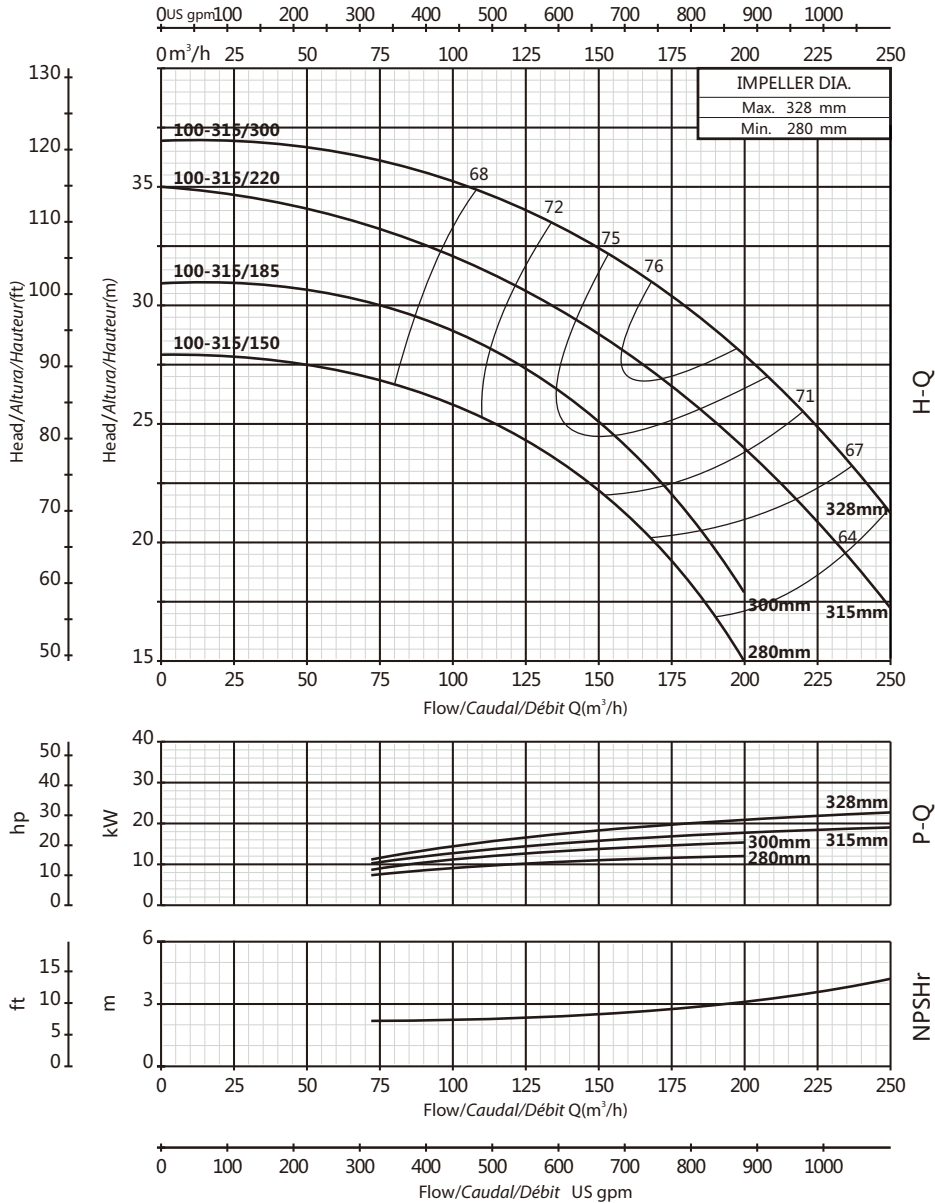

PERFORMANCE CURVE/CURVA DE RENDIMIENTO/COURBE DE PERFORMANCE

100-400

1450rpm

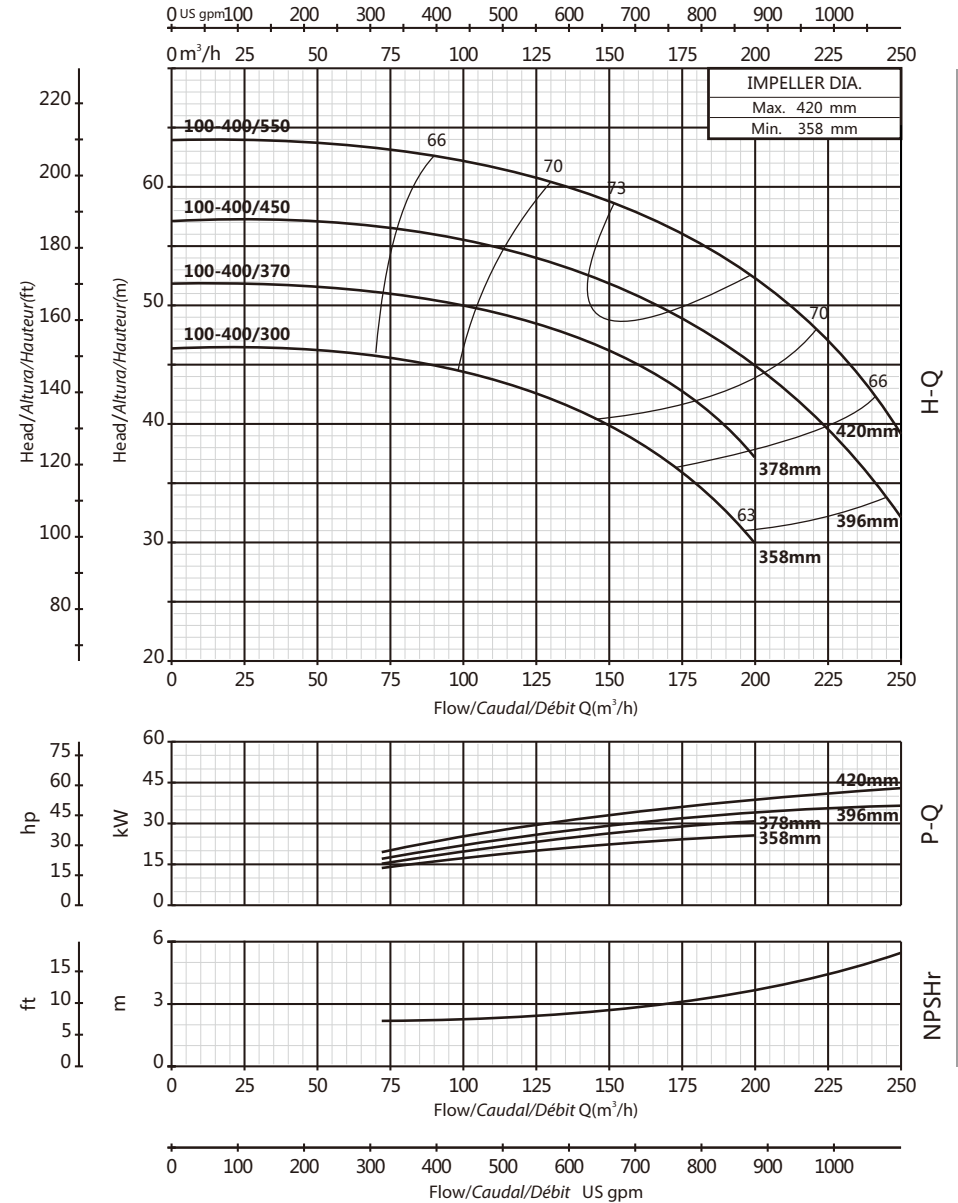

PERFORMANCE CURVE/CURVA DE RENDIMIENTO/COURBE DE PERFORMANCE

125-200

1450rpm

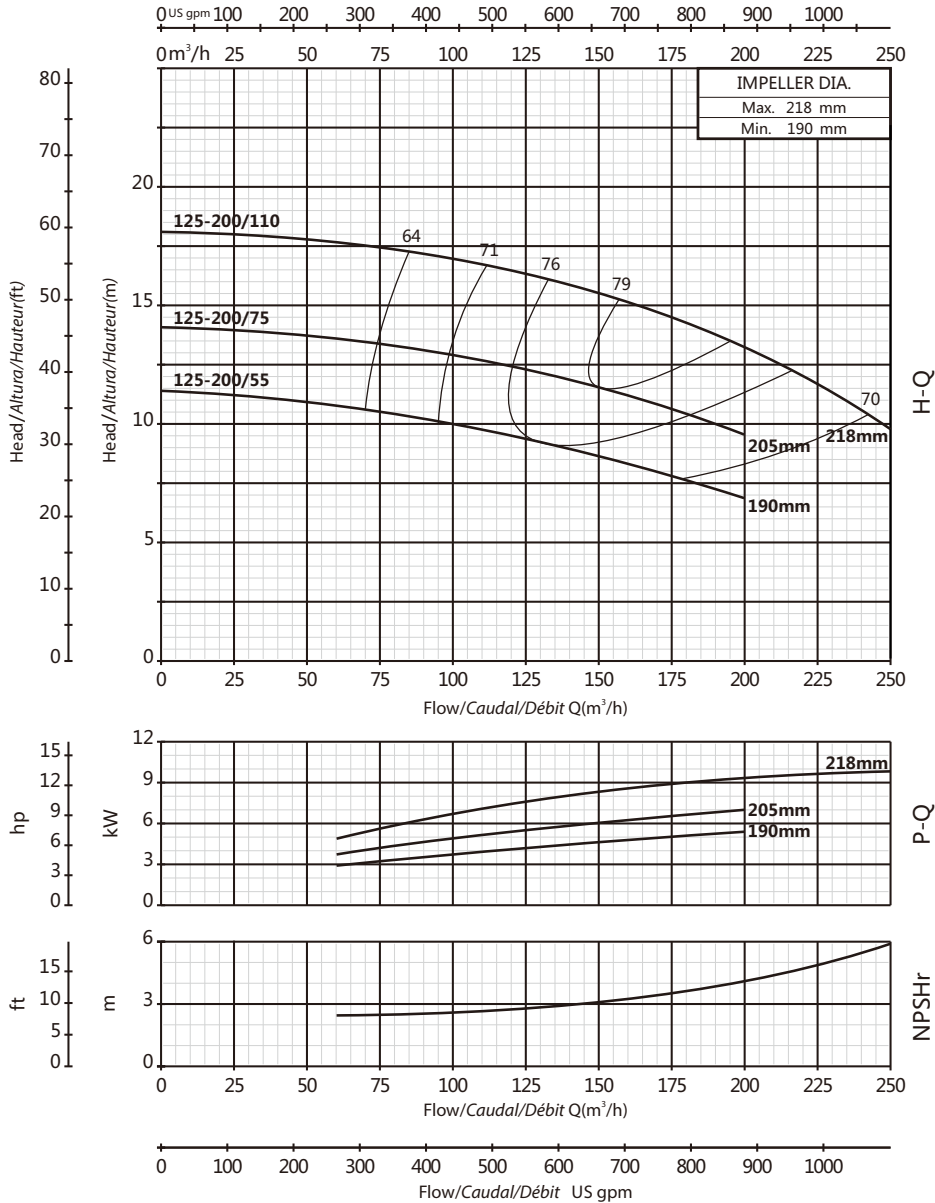

PERFORMANCE CURVE/CURVA DE RENDIMIENTO/COURBE DE PERFORMANCE

125-250

1450rpm

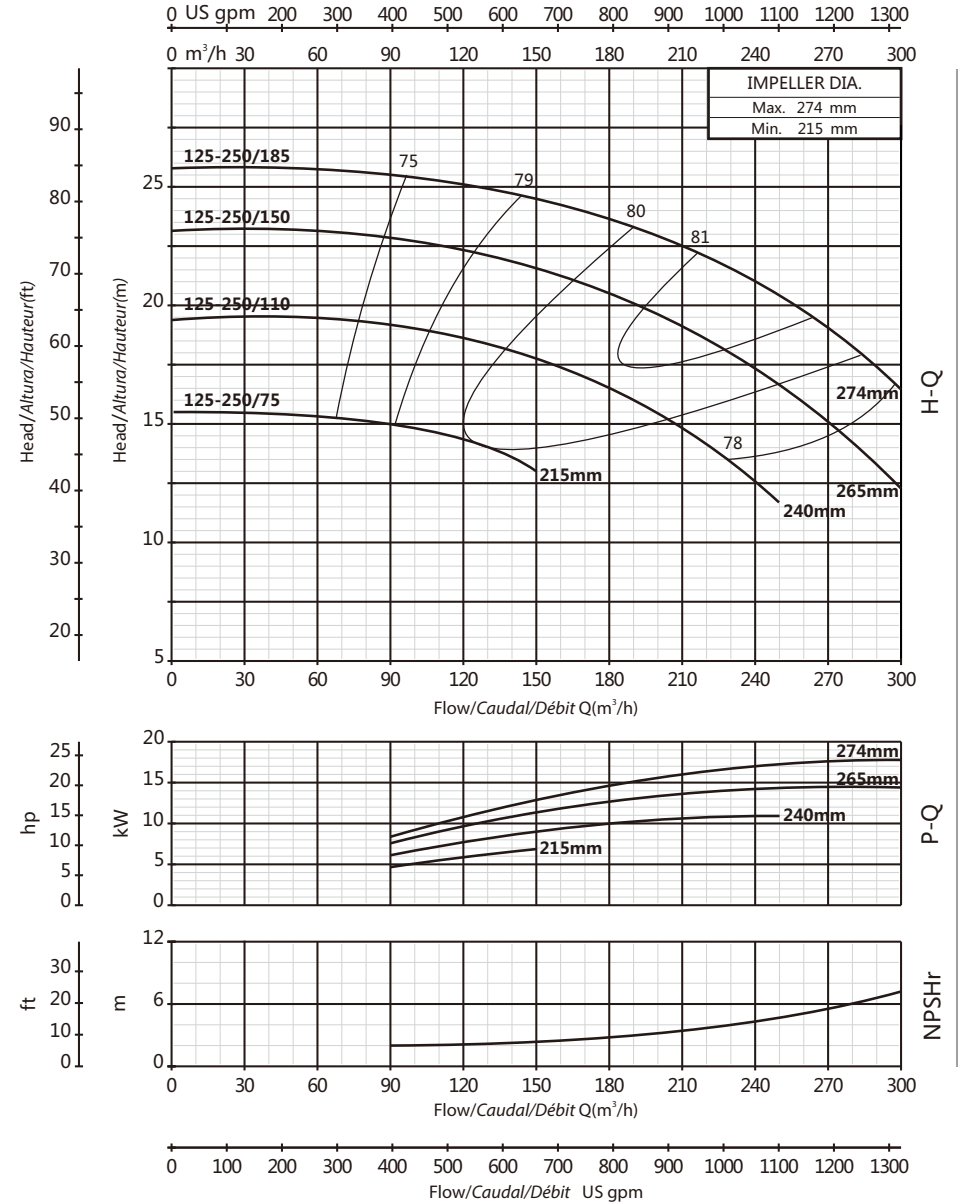

PERFORMANCE CURVE/CURVA DE RENDIMIENTO/COURBE DE PERFORMANCE

125-315

1450rpm

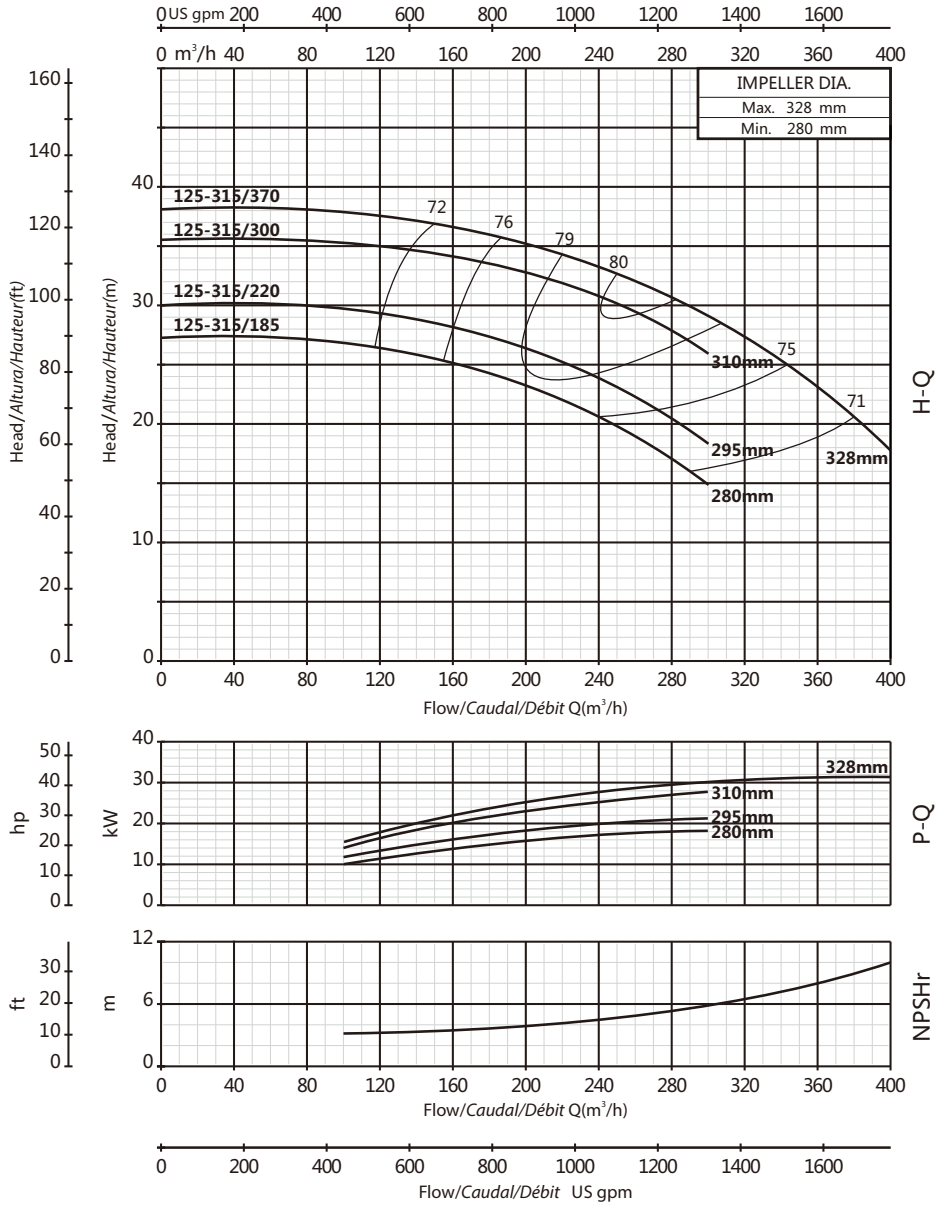

125-400

1450rpm

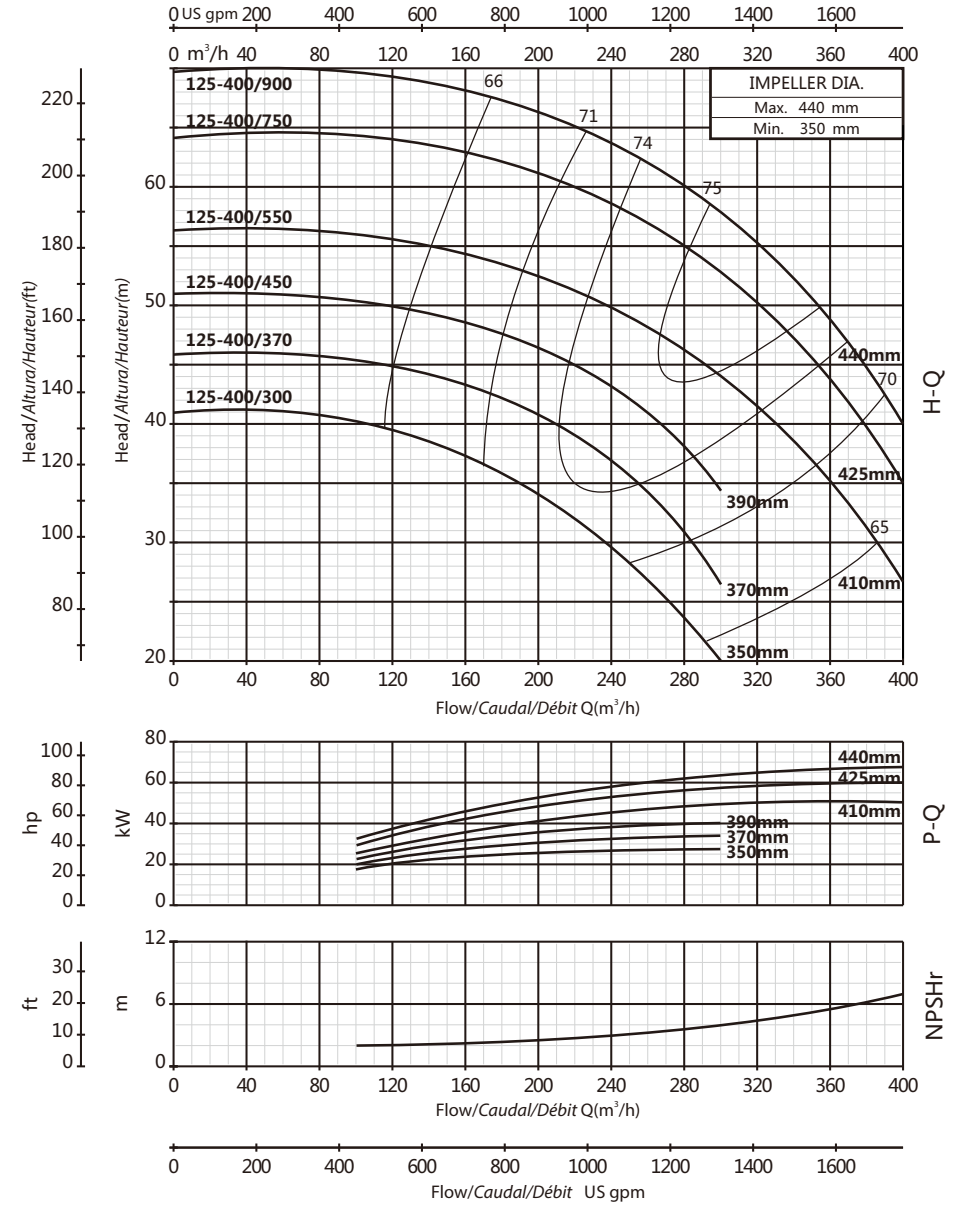

PERFORMANCE CURVE/CURVA DE RENDIMIENTO/COURBE DE PERFORMANCE

PERFORMANCE CURVE/CURVA DE RENDIMIENTO/COURBE DE PERFORMANCE

150-200

1450rpm

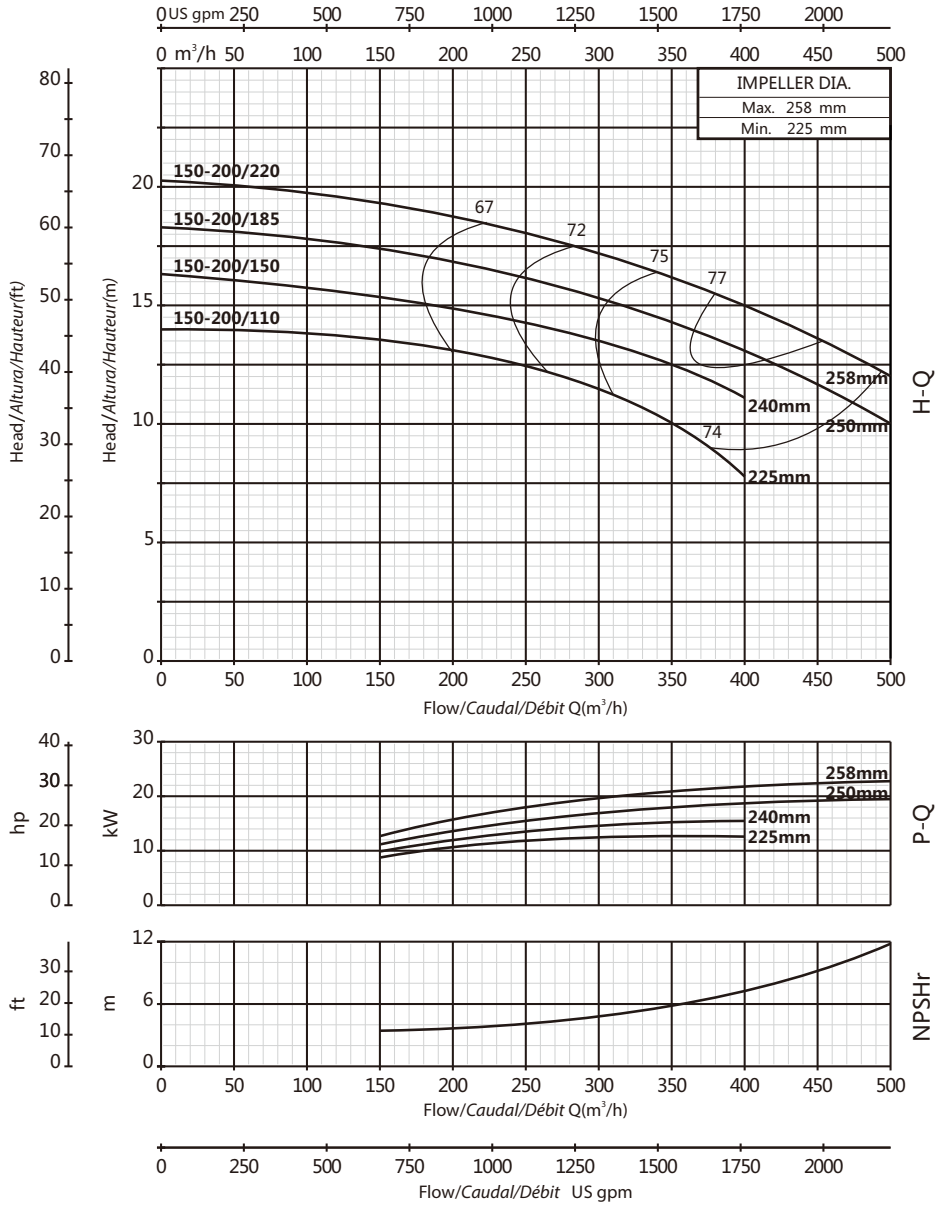

PERFORMANCE CURVE/CURVA DE RENDIMIENTO/COURBE DE PERFORMANCE

150-250

1450rpm

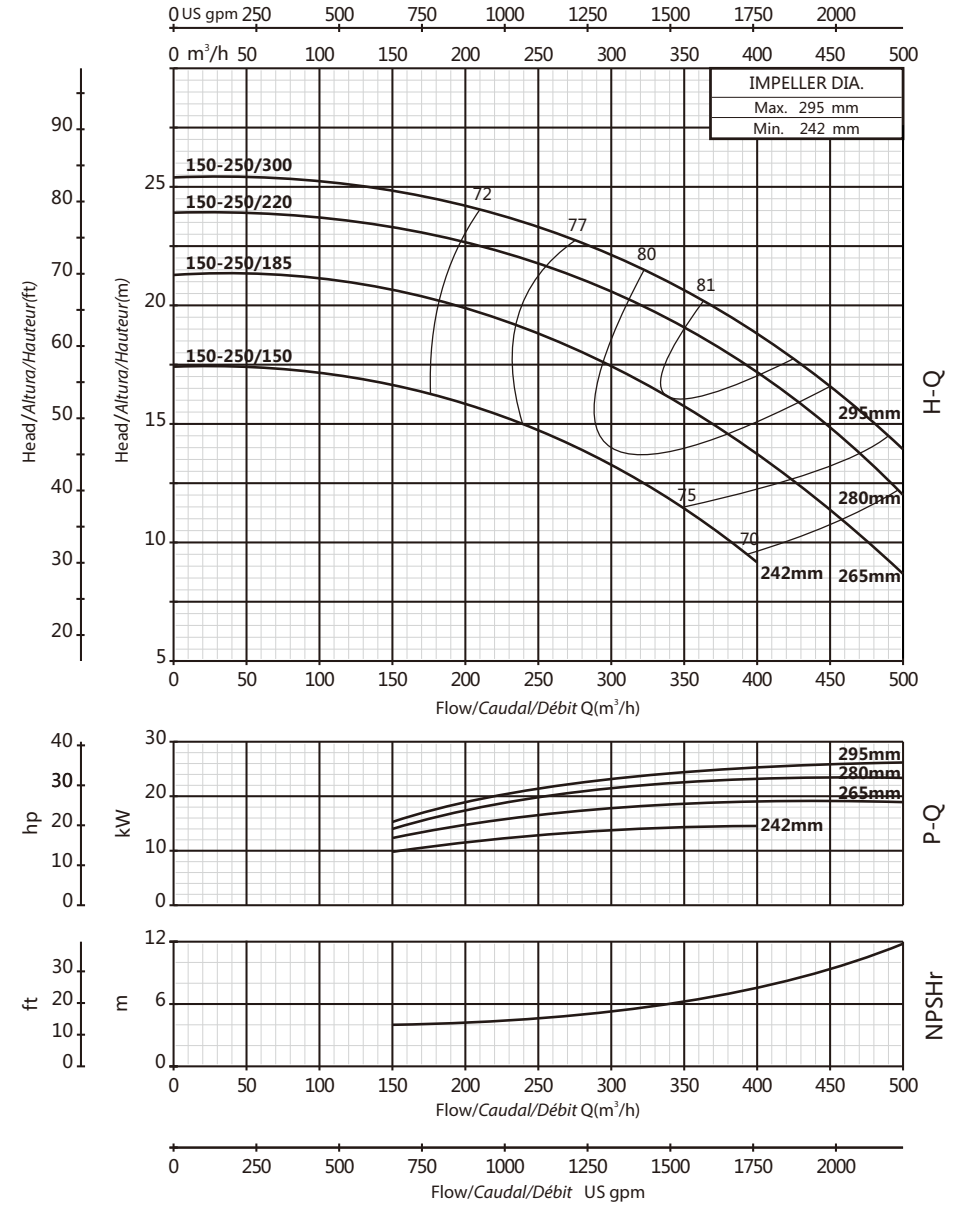

PERFORMANCE CURVE/CURVA DE RENDIMIENTO/COURBE DE PERFORMANCE

150-315

1450rpm

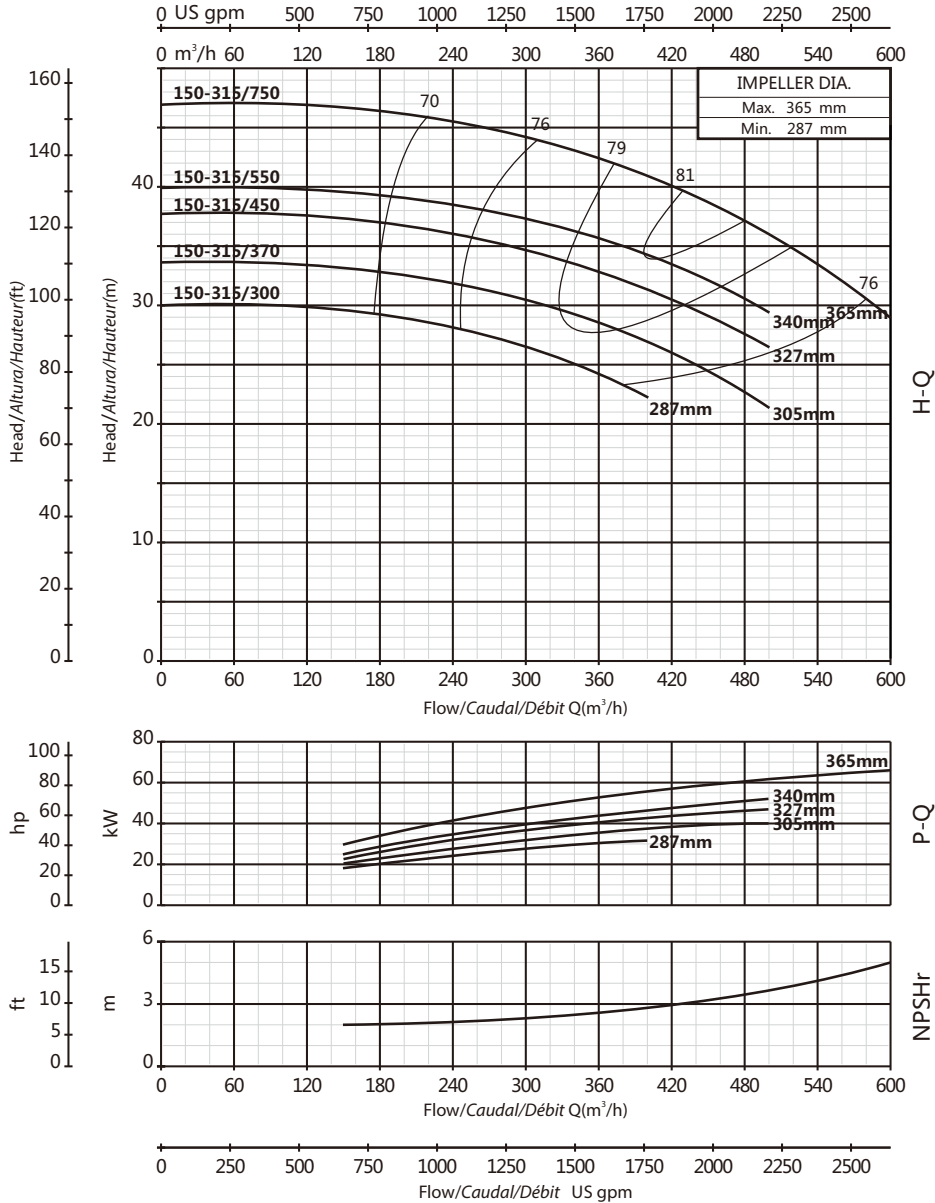

150-400

1450rpm

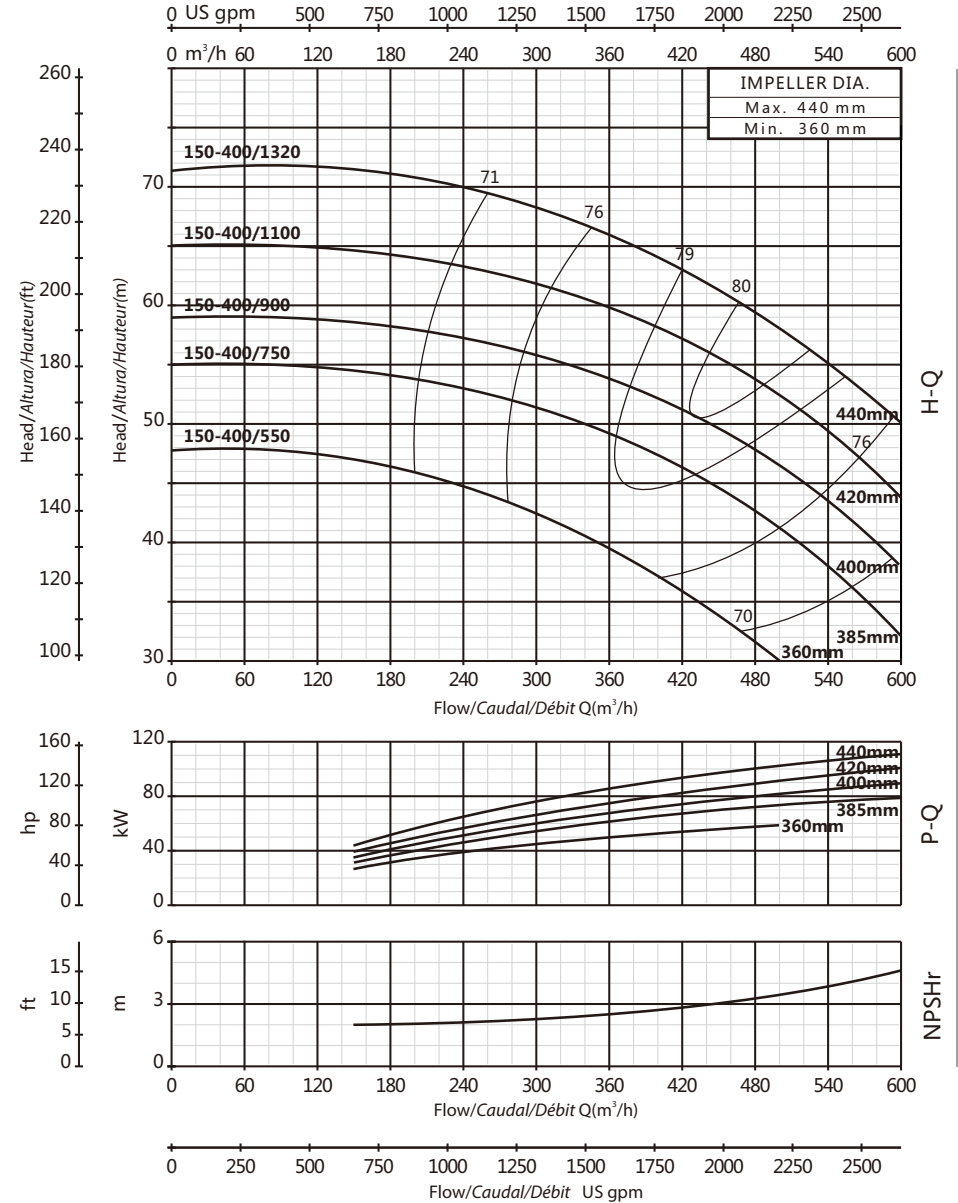

PERFORMANCE CURVE/CURVA DE RENDIMIENTO/COURBE DE PERFORMANCE

PERFORMANCE CURVE/CURVA DE RENDIMIENTO/COURBE DE PERFORMANCE

200-250

1450rpm

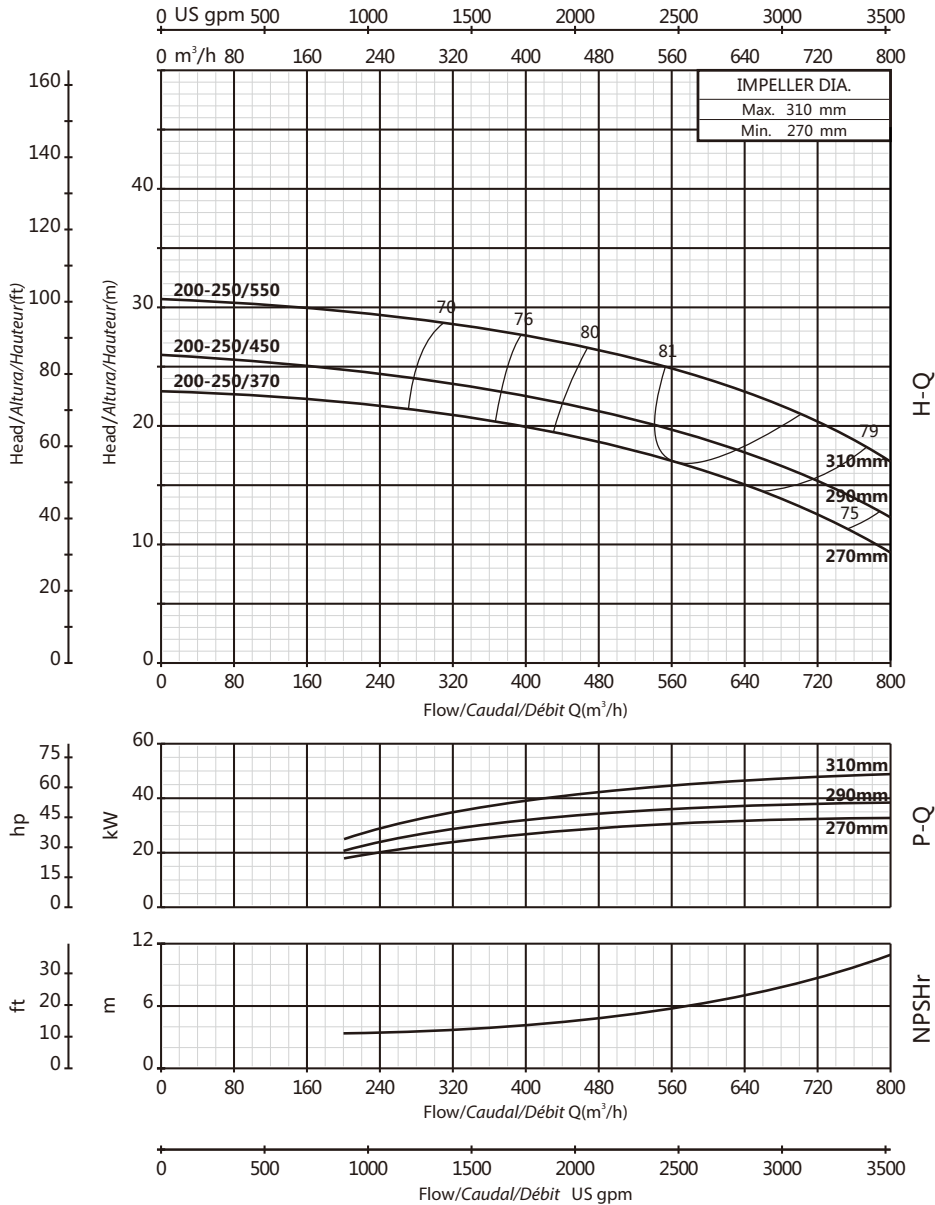

200-315

1450rpm

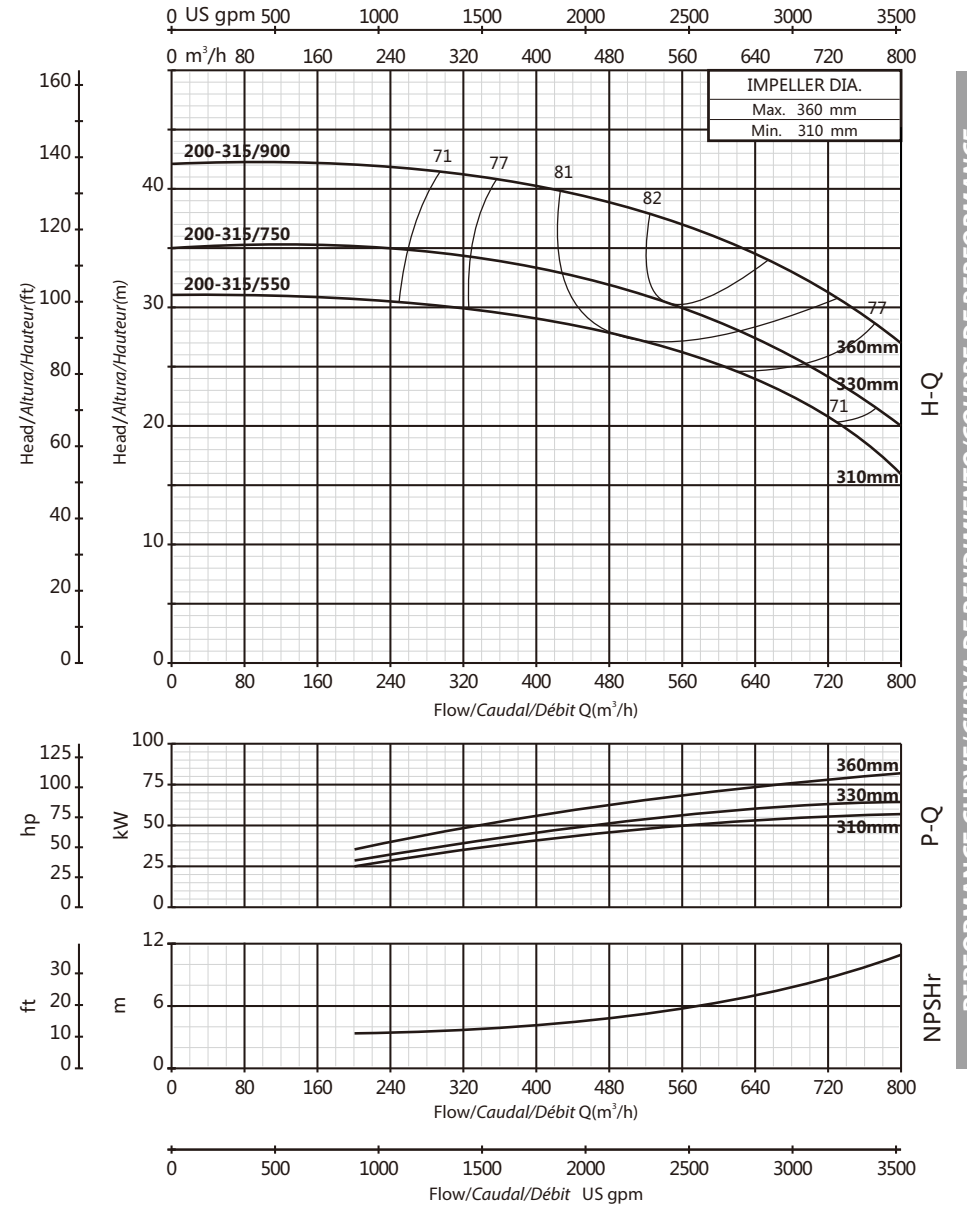

PERFORMANCE CURVE/CURVA DE RENDIMIENTO/COURBE DE PERFORMANCE

PERFORMANCE CURVE/CURVA DE RENDIMIENTO/COURBE DE PERFORMANCE

200-400

1450rpm

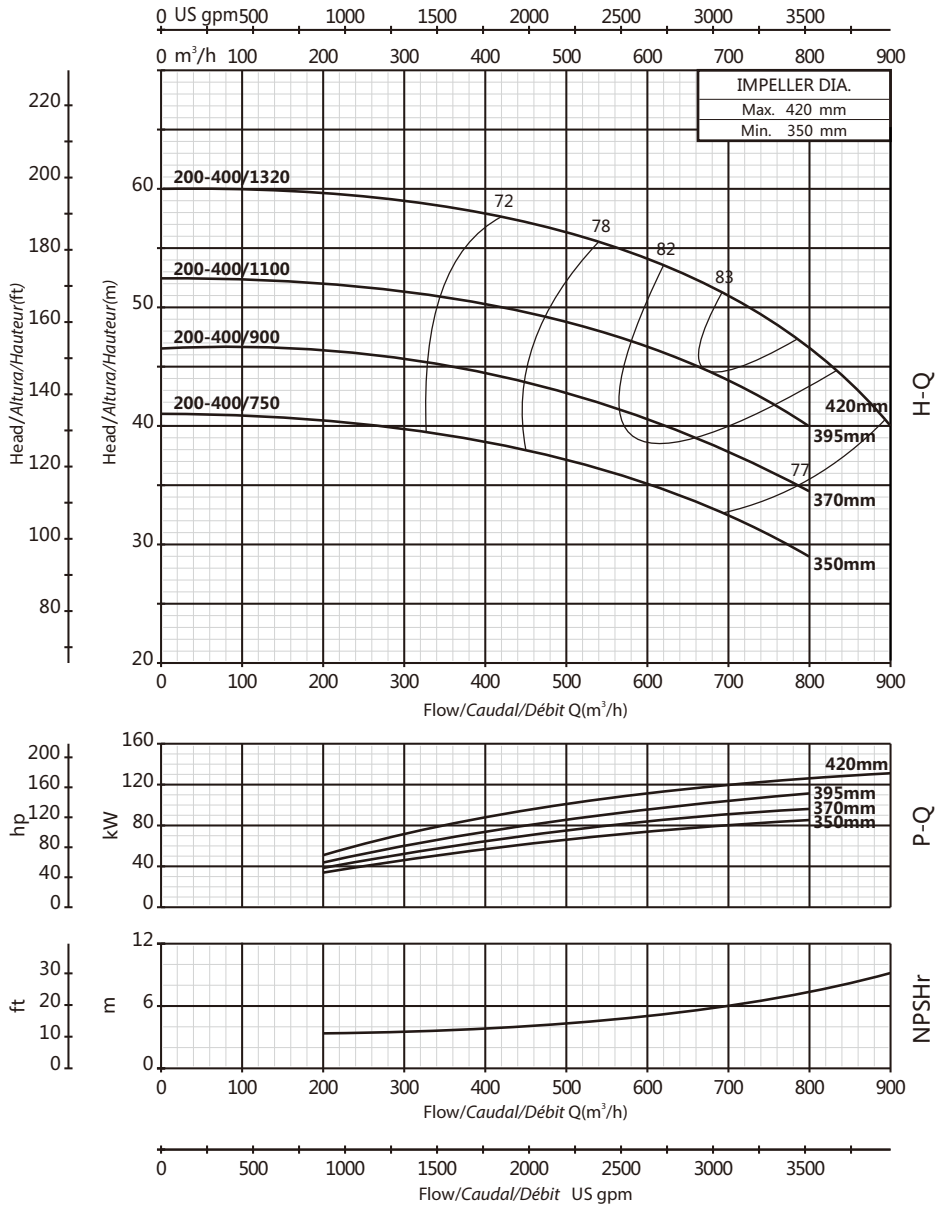

250-315

1450rpm

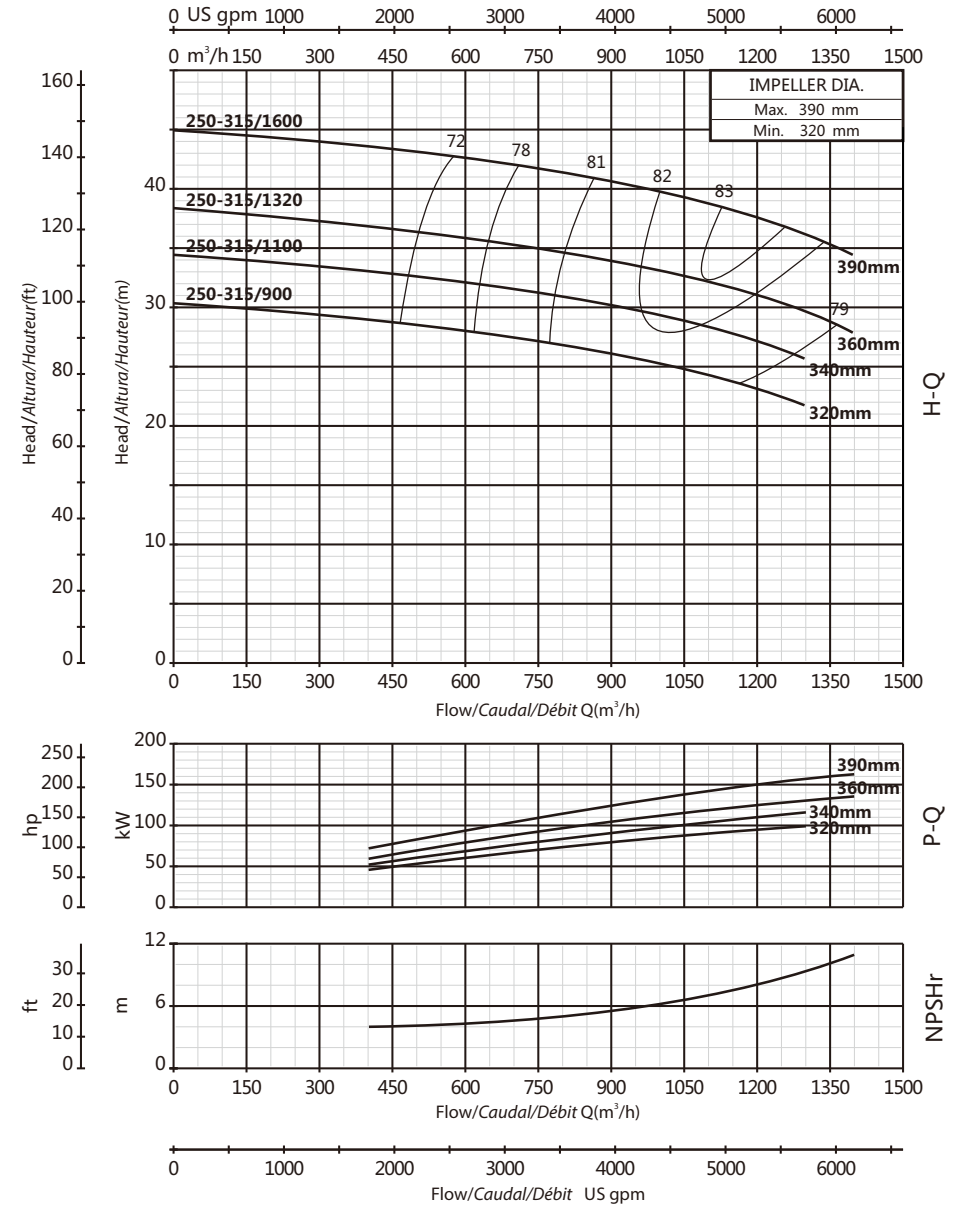

PERFORMANCE CURVE/CURVA DE RENDIMIENTO/COURBE DE PERFORMANCE

PERFORMANCE CURVE/CURVA DE RENDIMIENTO/COURBE DE PERFORMANCE

250-400

1450rpm

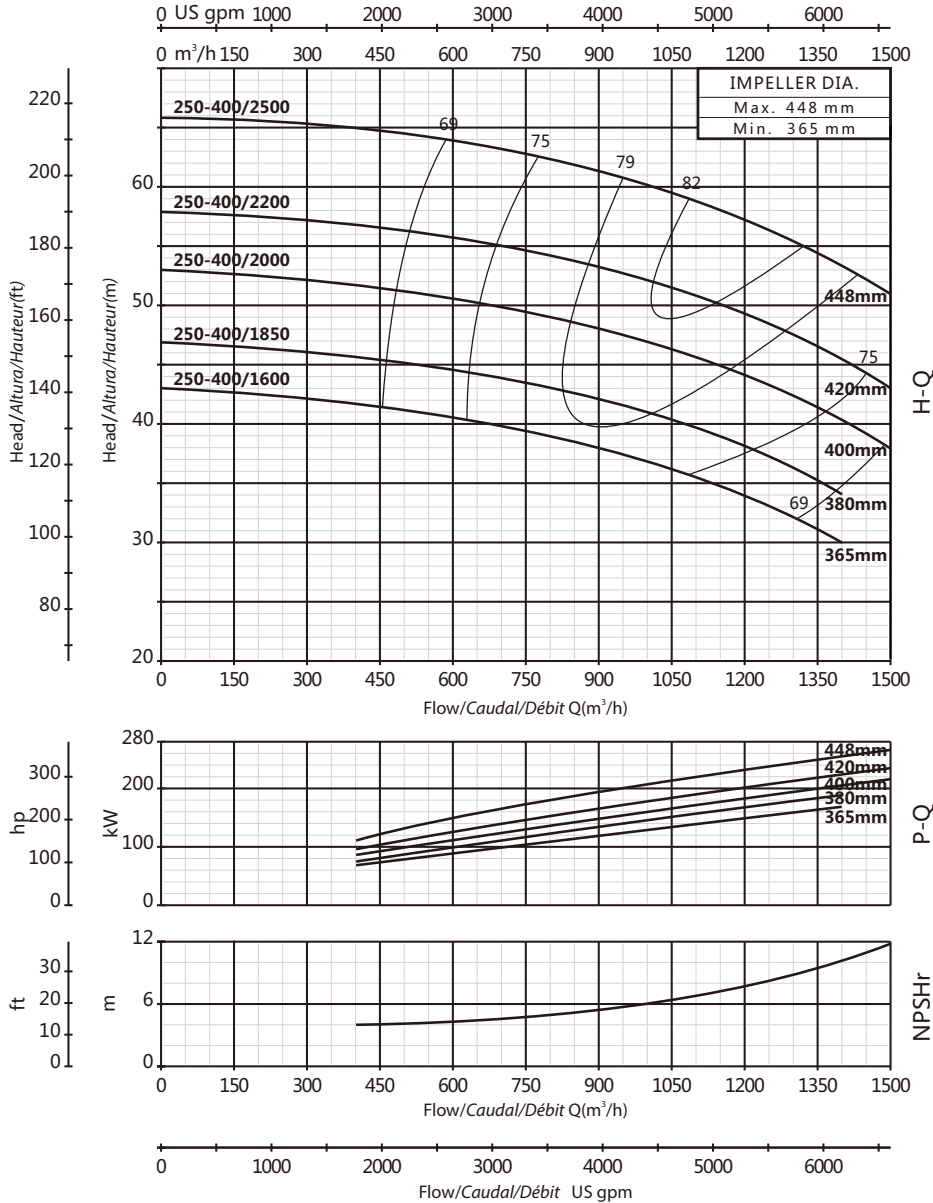

PV 4

2900rpm

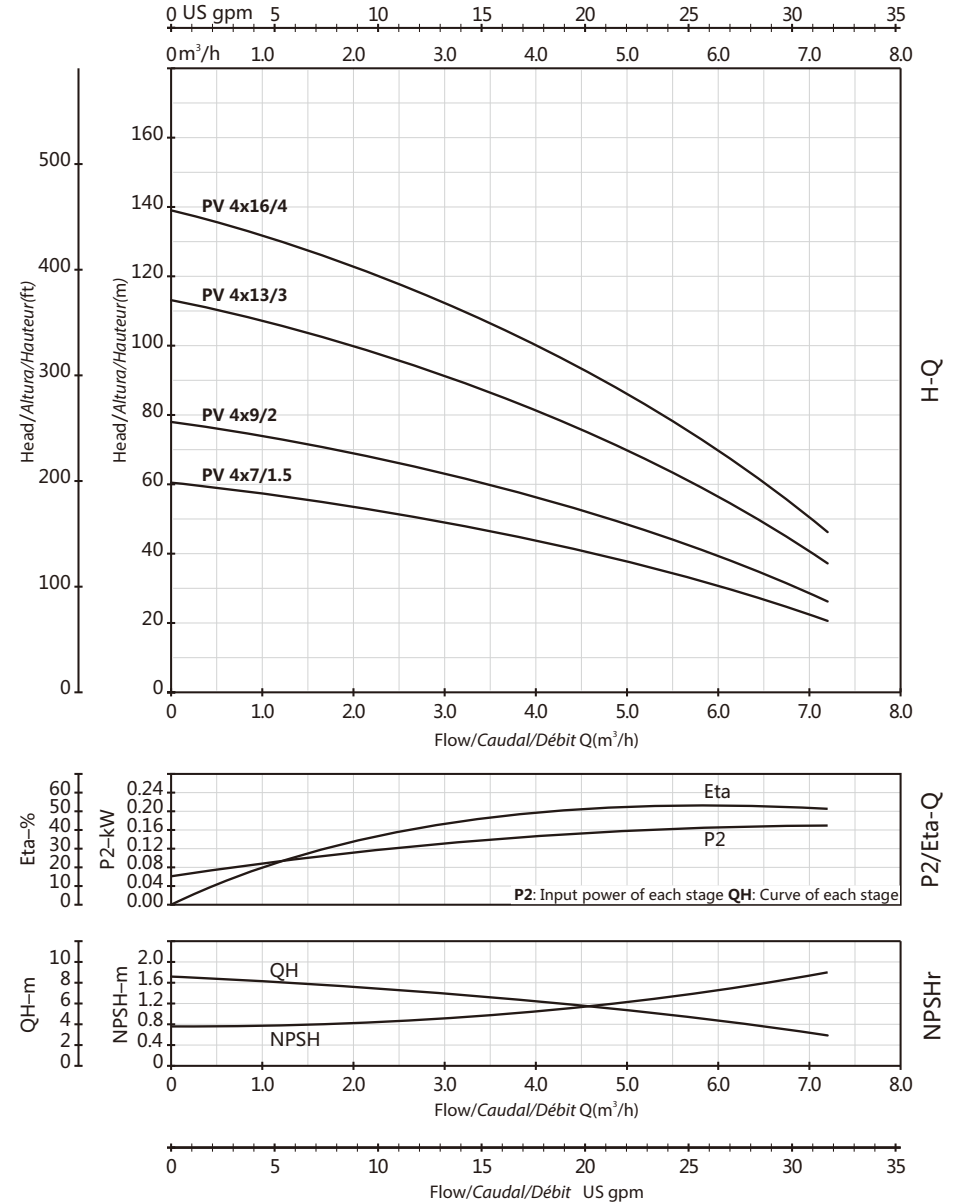

PERFORMANCE CURVE/CURVA DE RENDIMIENTO/COURBE DE PERFORMANCE

PERFORMANCE CURVE/CURVA DE RENDIMIENTO/COURBE DE PERFORMANCE

PV 6

2900rpm

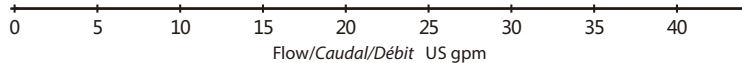
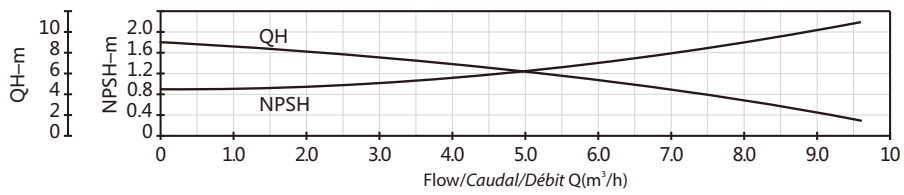
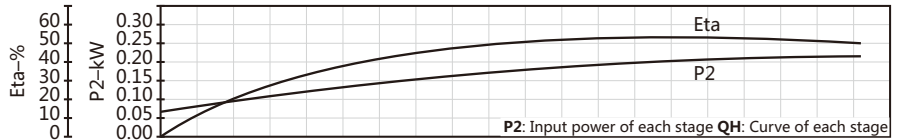
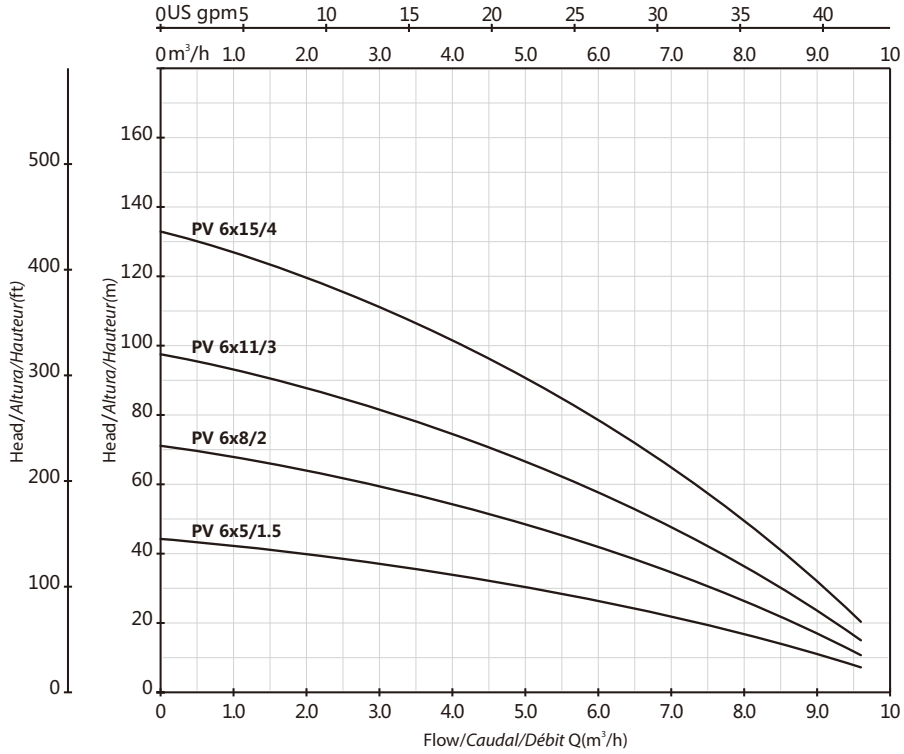

PERFORMANCE CURVE/CURVA DE RENDIMIENTO/COURBE DE PERFORMANCE

PV 8

2900rpm

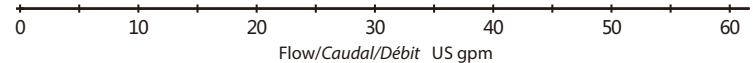
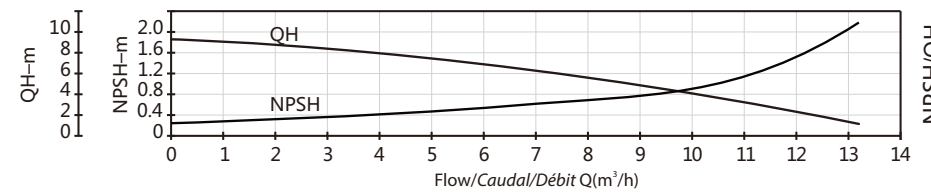
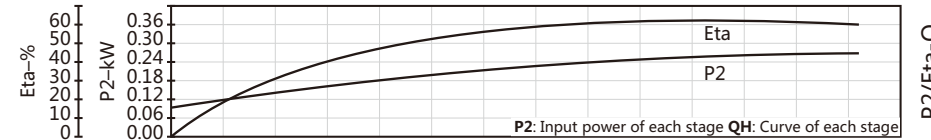
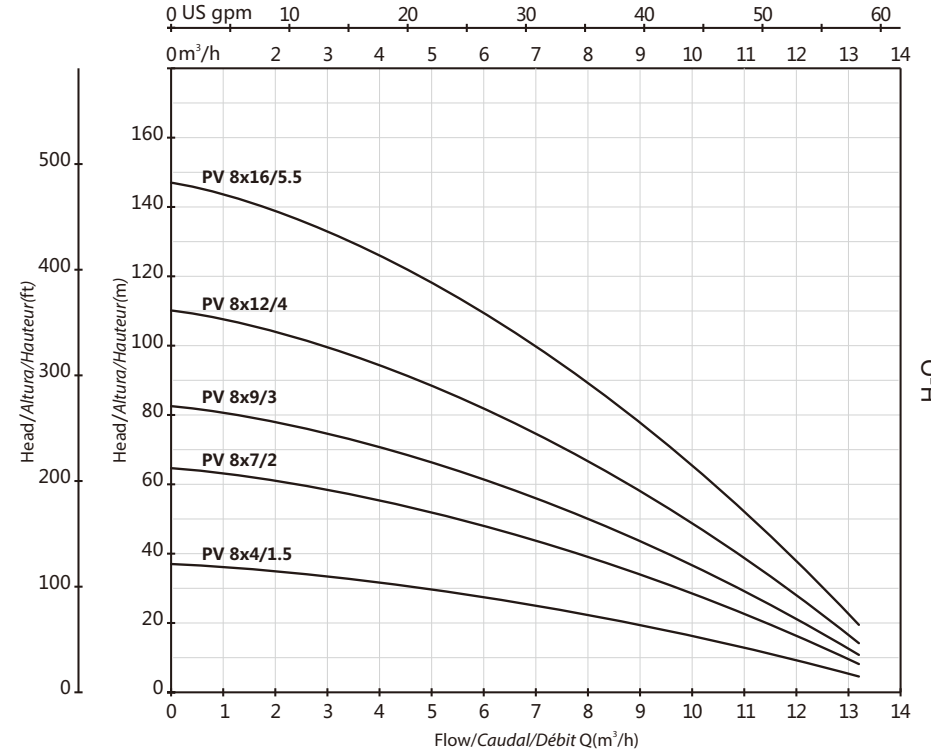

PERFORMANCE CURVE/CURVA DE RENDIMIENTO/COURBE DE PERFORMANCE

PV 12

2900rpm

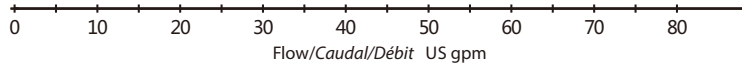
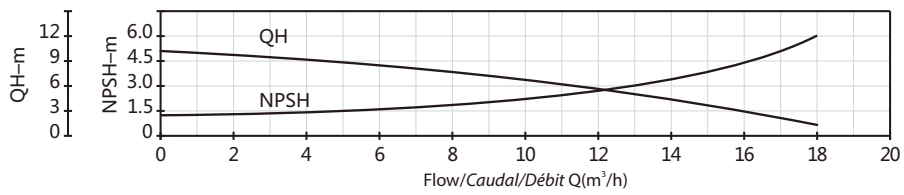
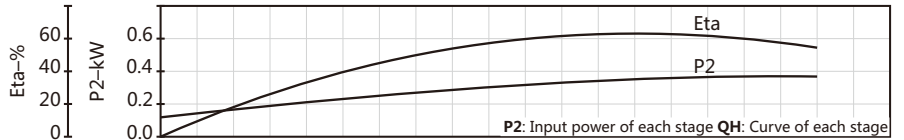
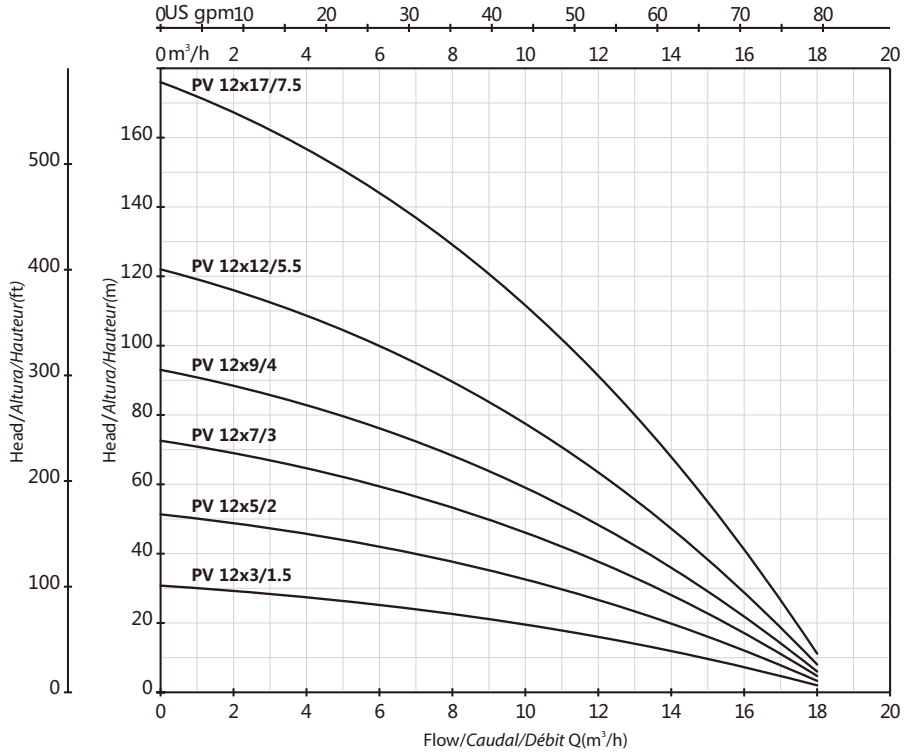

PERFORMANCE CURVE/CURVA DE RENDIMIENTO/COURBE DE PERFORMANCE

H-Q

P2/Eta-Q

NPSH/QH

PV 30

2900rpm

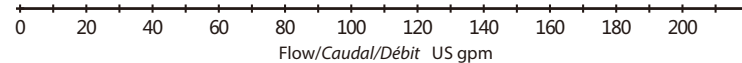
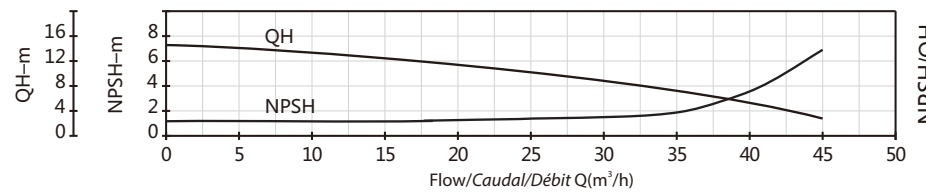
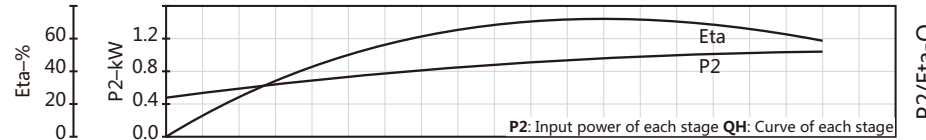
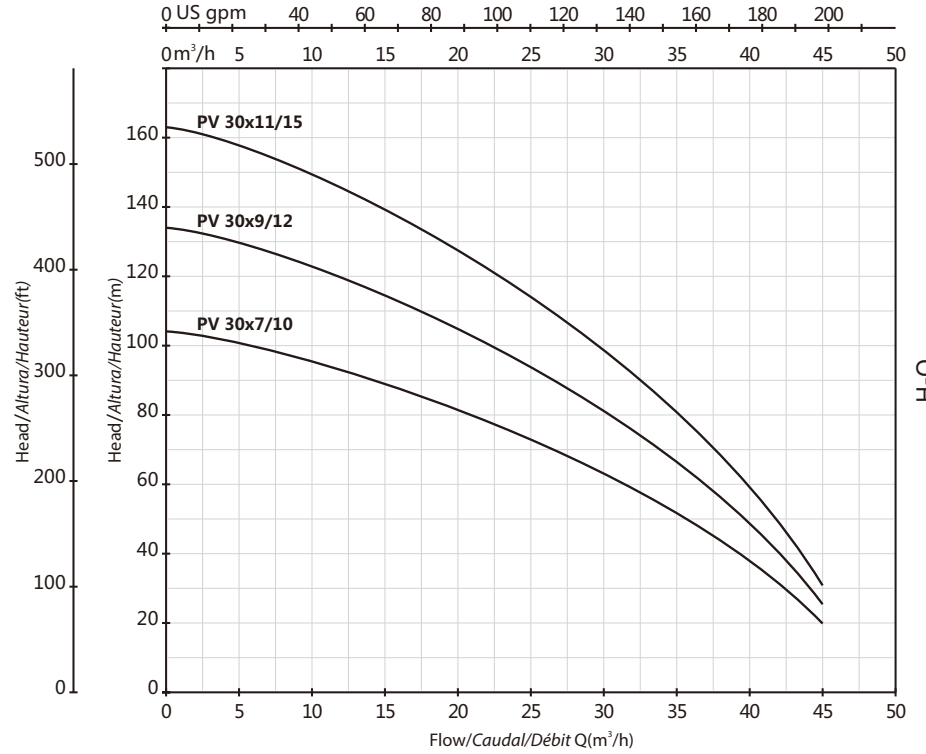

PERFORMANCE CURVE/CURVA DE RENDIMIENTO/COURBE DE PERFORMANCE

H-Q

P2/Eta-Q

NPSH/QH

PVT(S)1

2900rpm

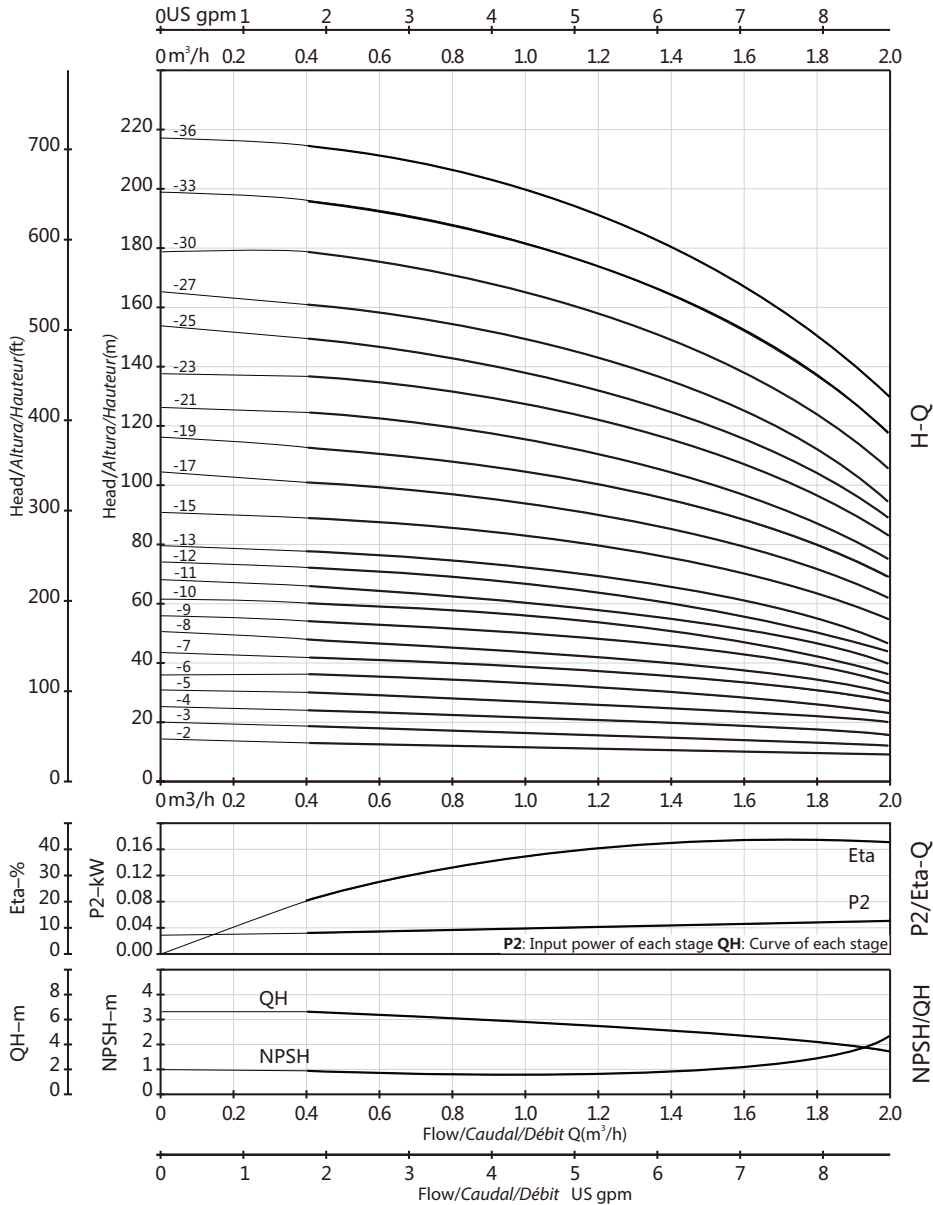

PERFORMANCE CURVE/CURVA DE RENDIMIENTO/COURBE DE PERFORMANCE

PVT(S)2

2900rpm

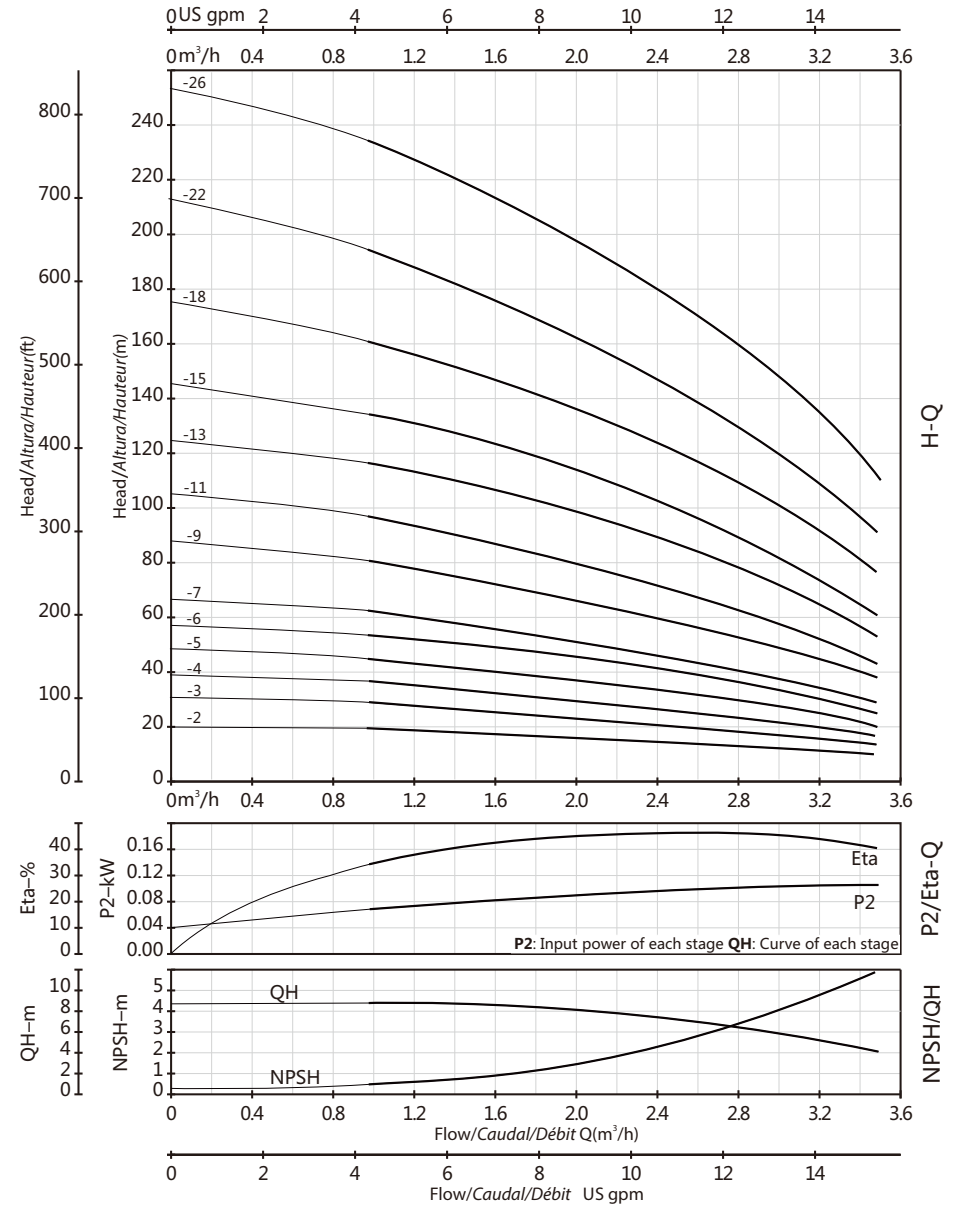

PERFORMANCE CURVE/CURVA DE RENDIMIENTO/COURBE DE PERFORMANCE

PVT(S)3

2900rpm

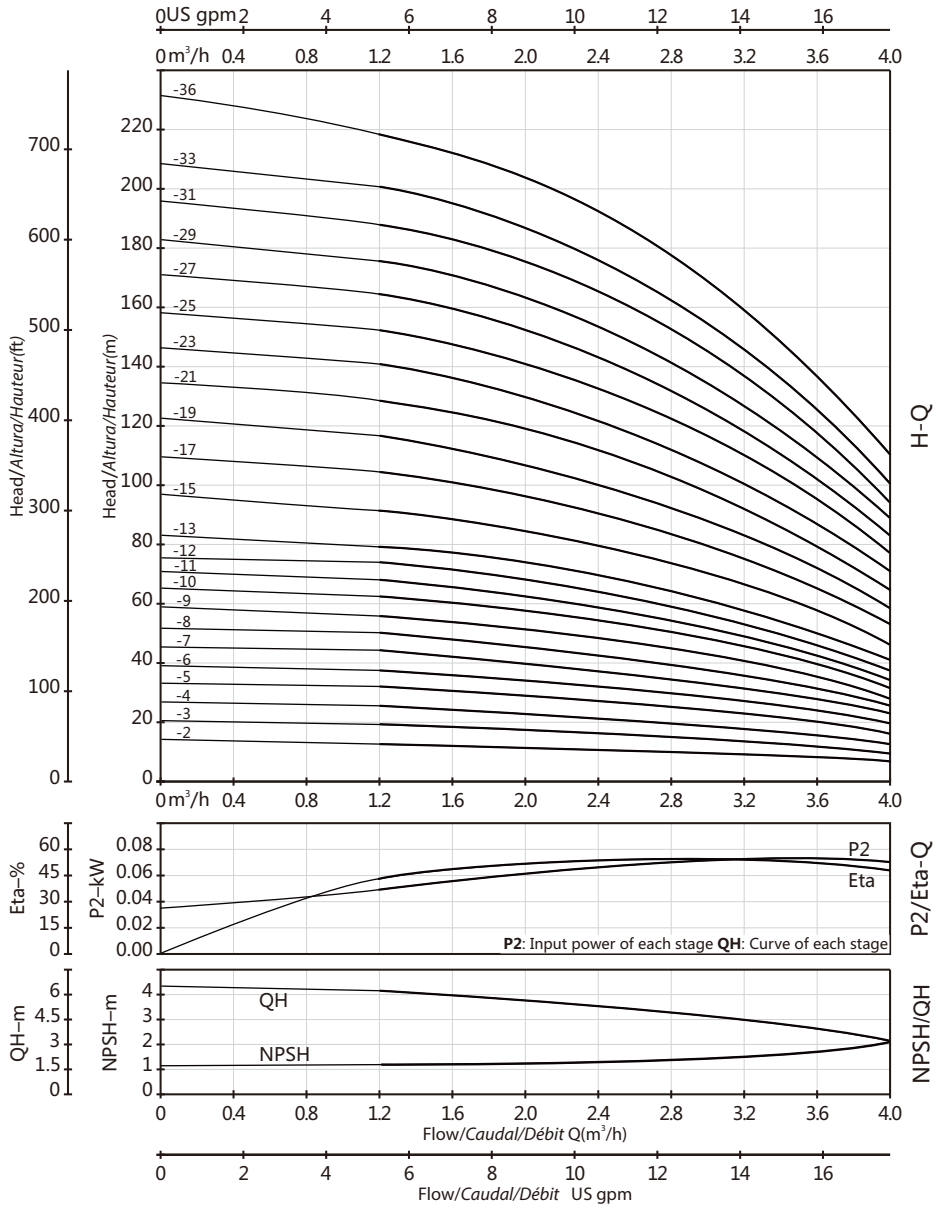

PERFORMANCE CURVE/CURVA DE RENDIMIENTO/COURBE DE PERFORMANCE

PVT(S)4

2900rpm

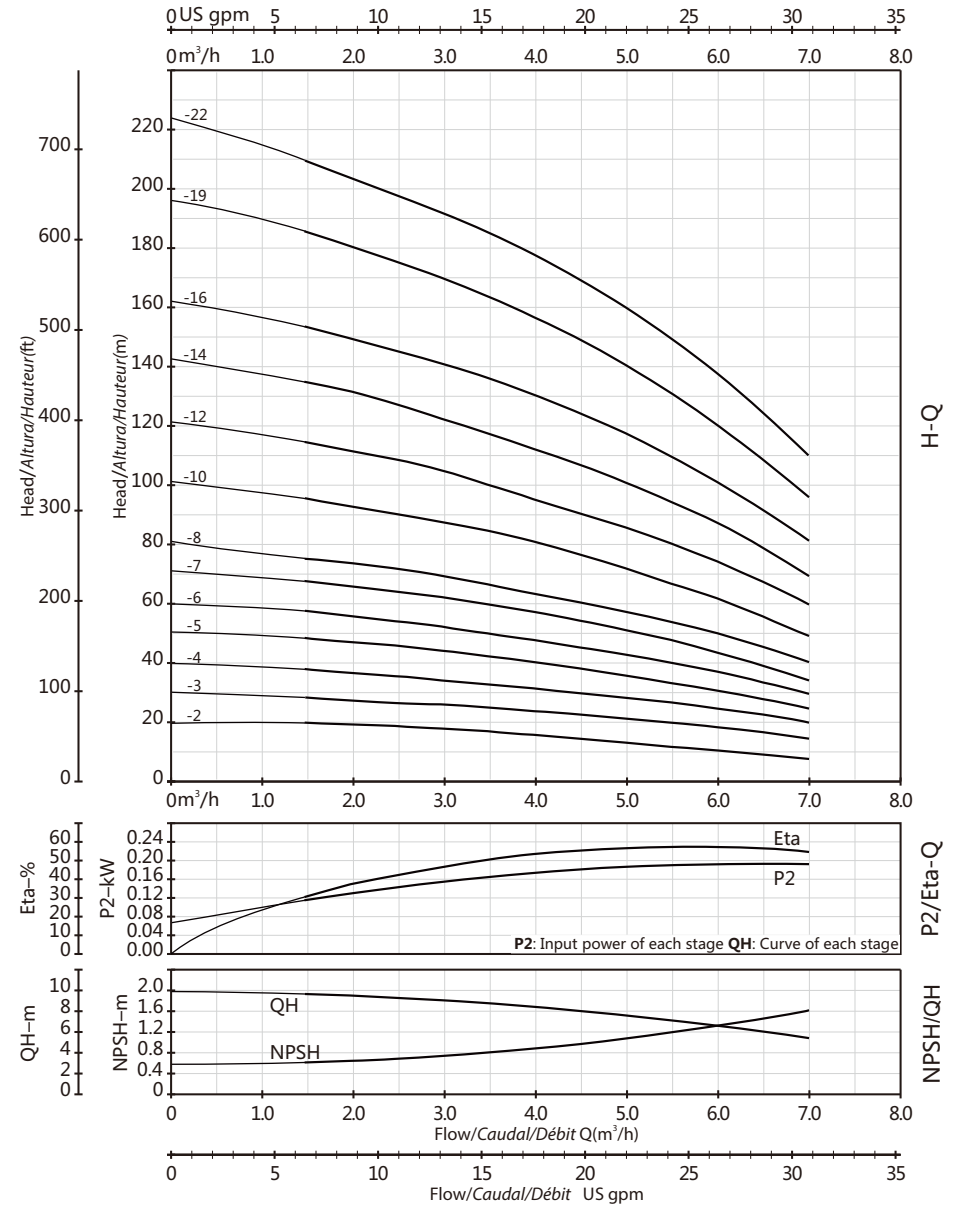

PERFORMANCE CURVE/CURVA DE RENDIMIENTO/COURBE DE PERFORMANCE

PVT(S)8

2900rpm

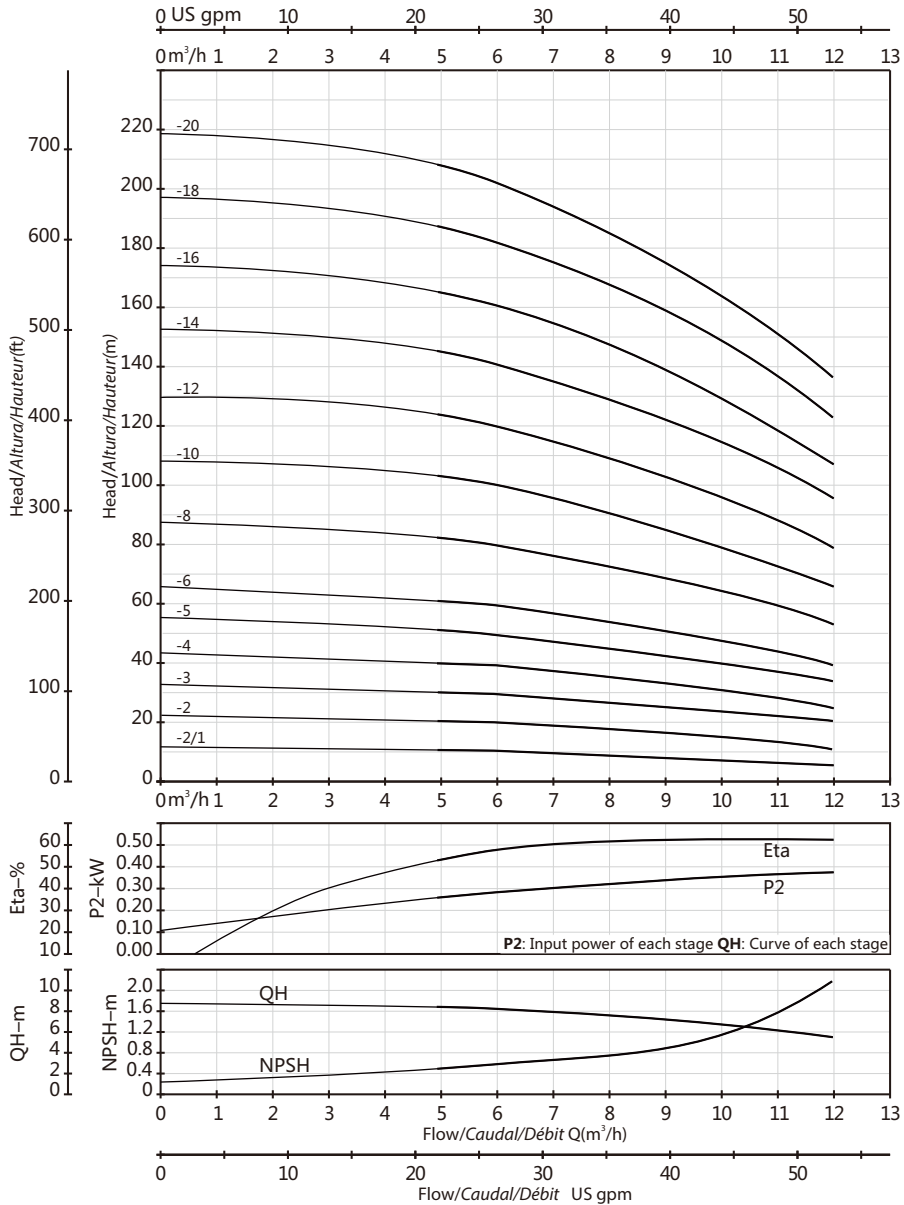

PERFORMANCE CURVE/CURVA DE RENDIMIENTO/COURBE DE PERFORMANCE

PVT(S)10

2900rpm

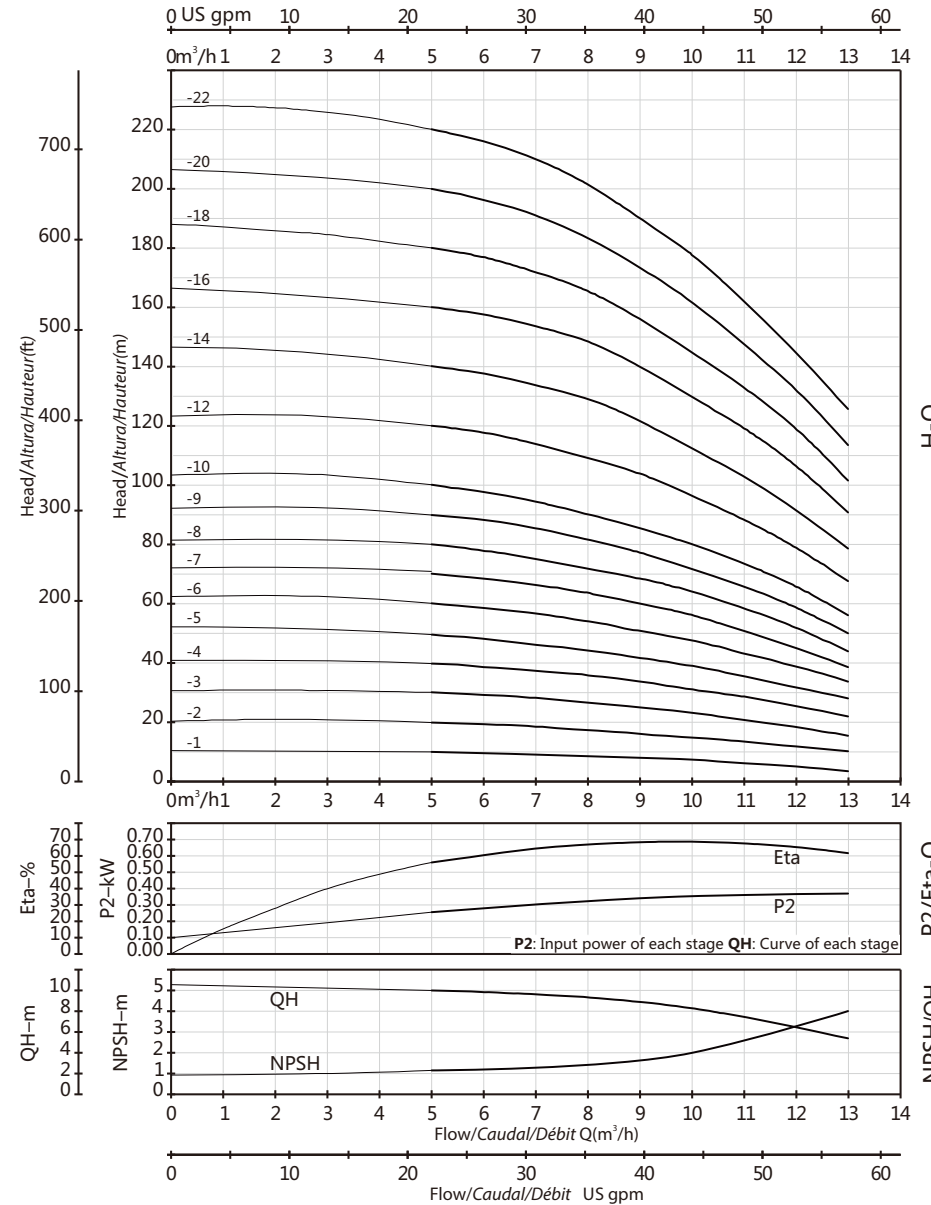

PERFORMANCE CURVE/CURVA DE RENDIMIENTO/COURBE DE PERFORMANCE

PVT(S)12

2900rpm

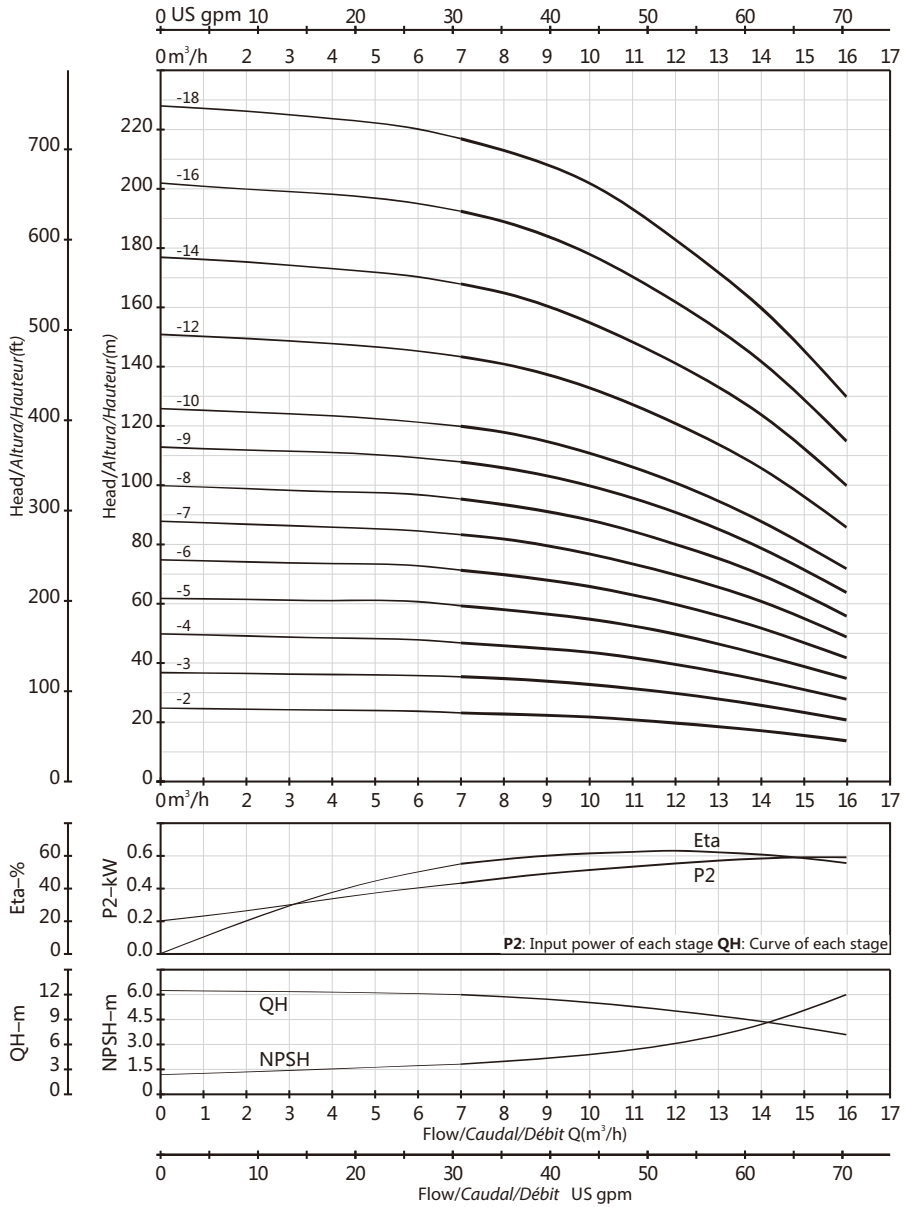

PERFORMANCE CURVE/CURVA DE RENDIMIENTO/COURBE DE PERFORMANCE

PVT(S)16

2900rpm

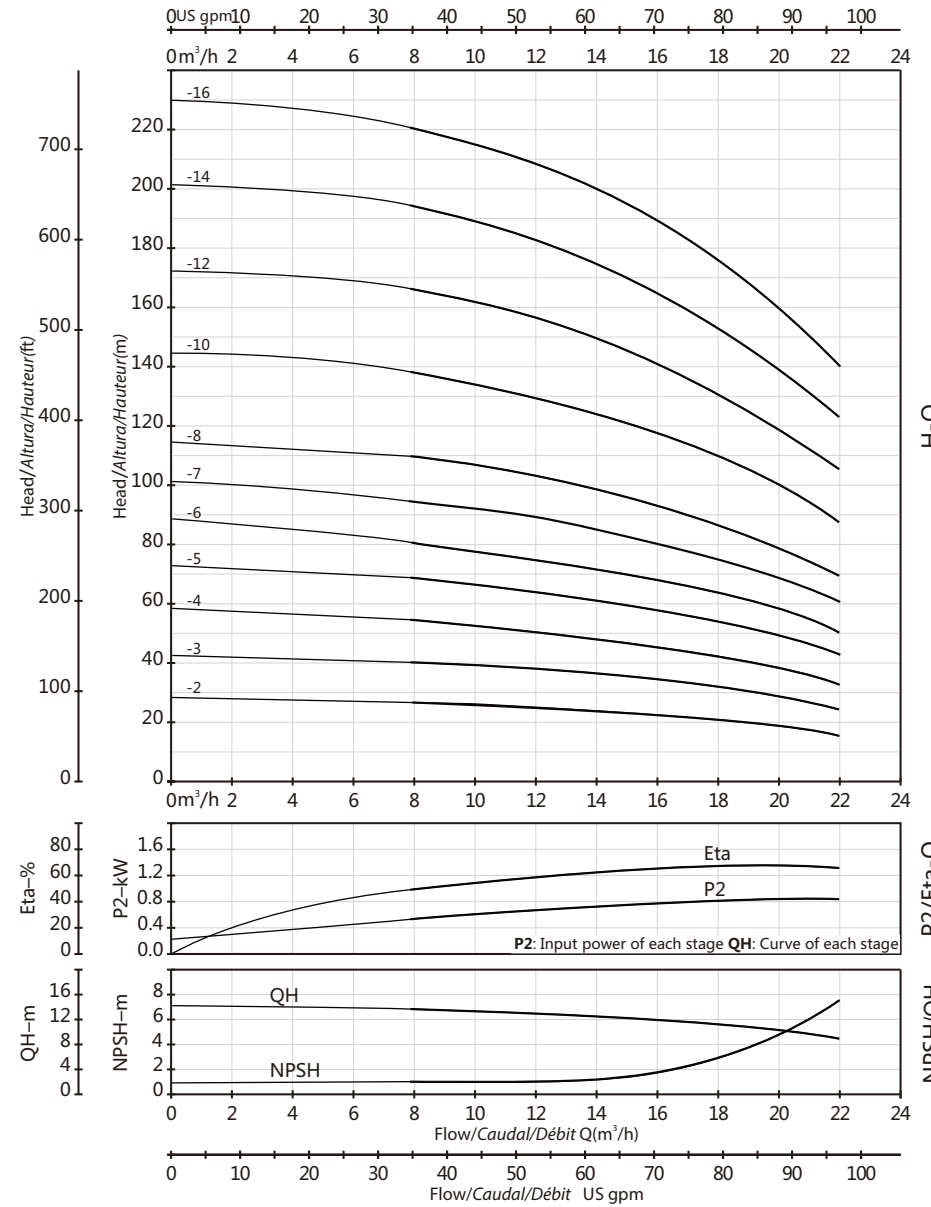

PERFORMANCE CURVE/CURVA DE RENDIMIENTO/COURBE DE PERFORMANCE

PVT(S)20

2900rpm

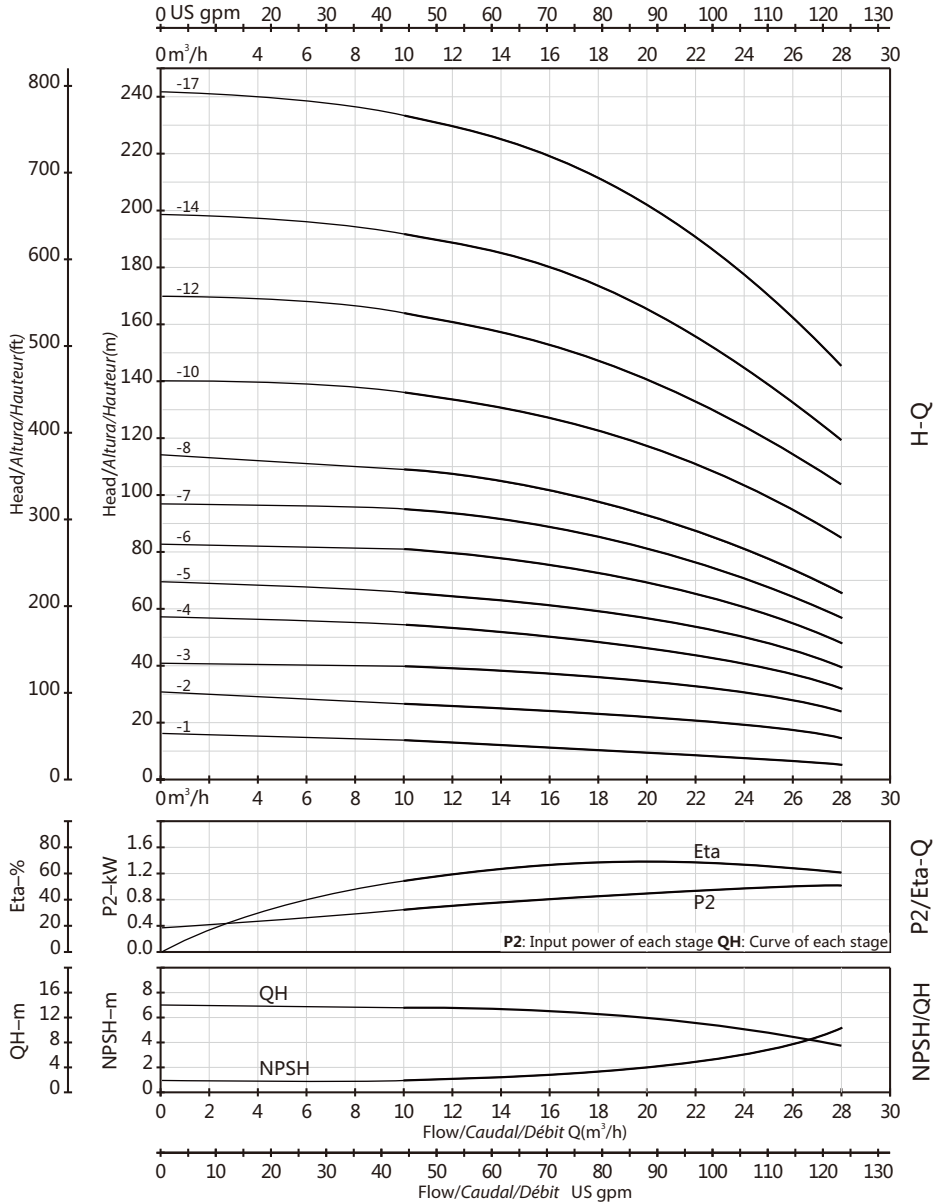

PERFORMANCE CURVE/CURVA DE RENDIMIENTO/COURBE DE PERFORMANCE

PVT(S)32

2900rpm

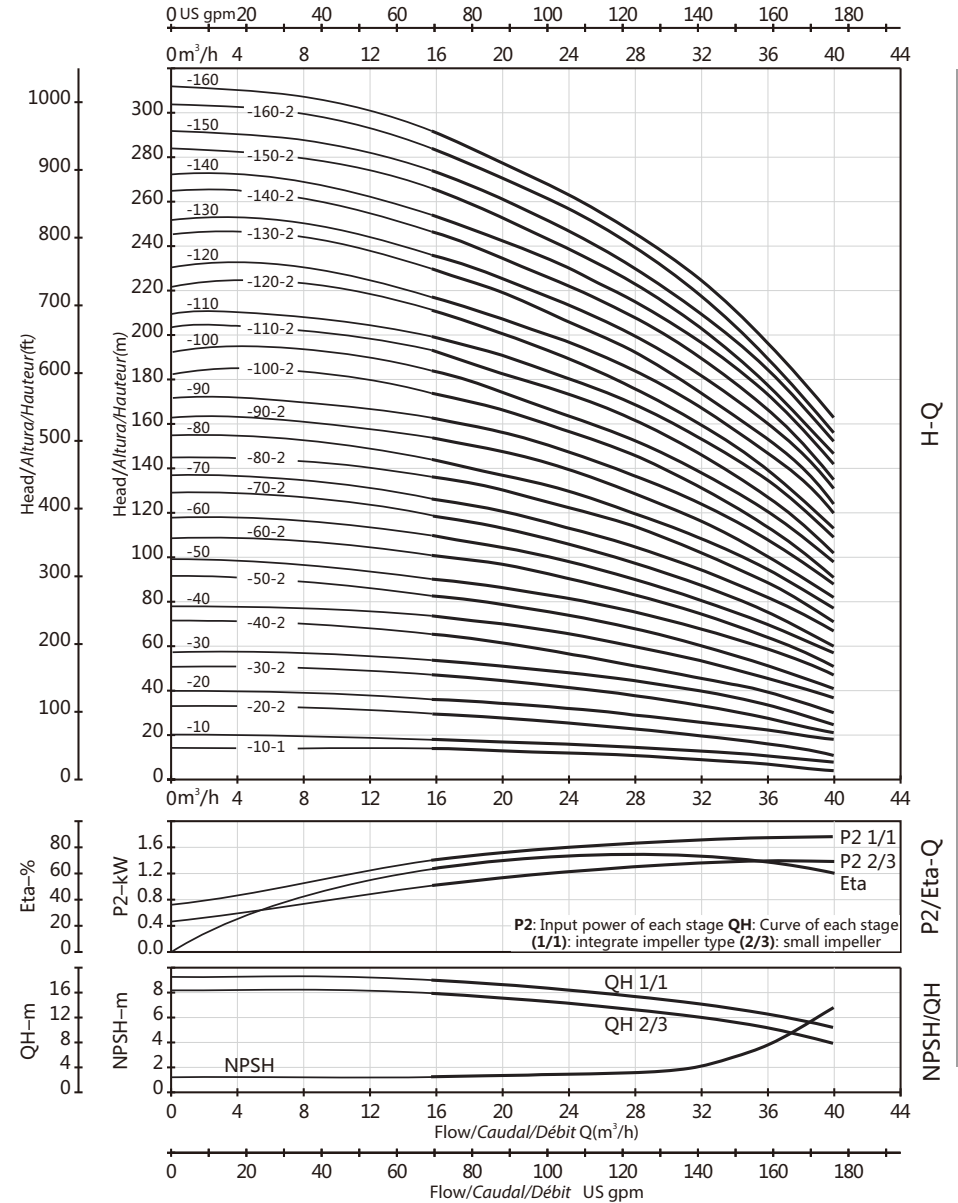

PERFORMANCE CURVE/CURVA DE RENDIMIENTO/COURBE DE PERFORMANCE

PVT(S)45

2900rpm

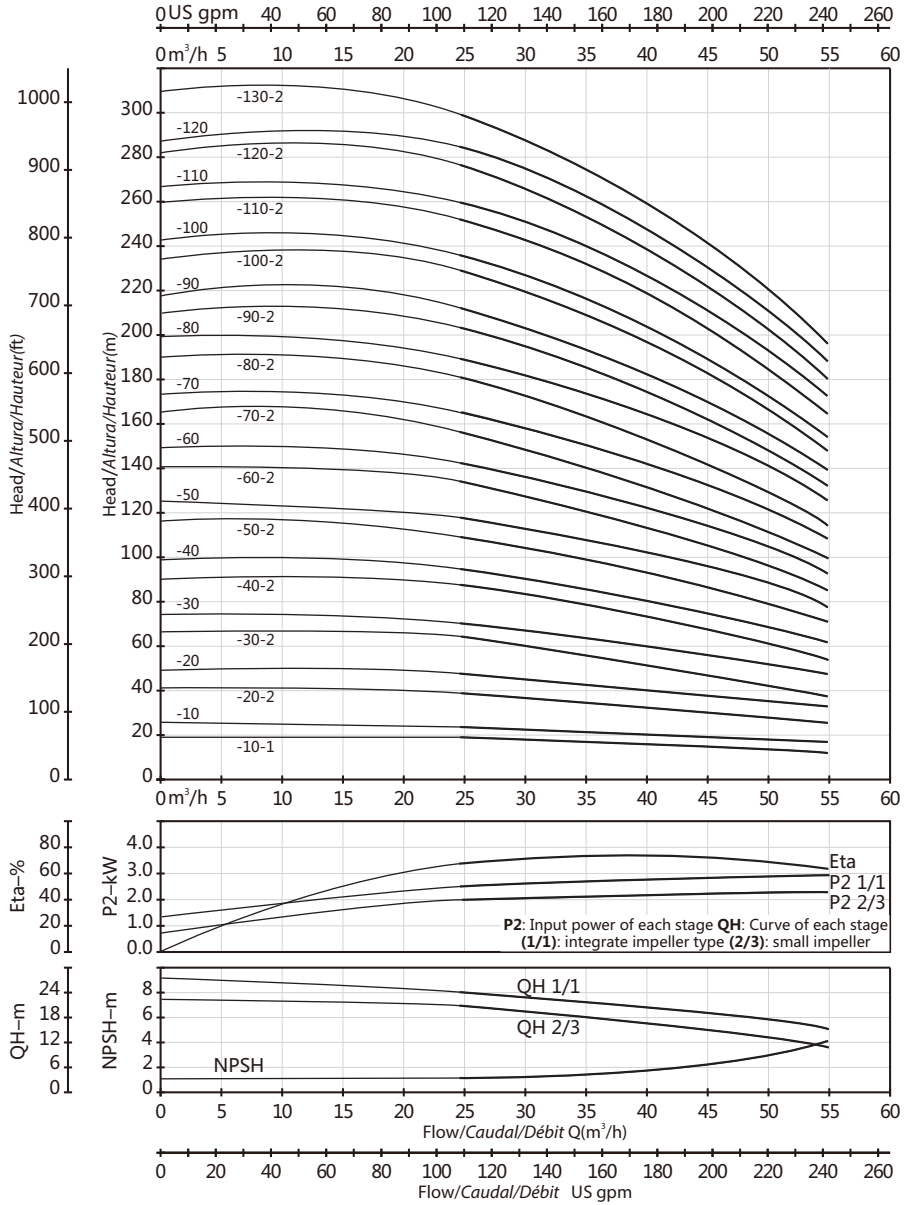

PVT(S)64

2900rpm

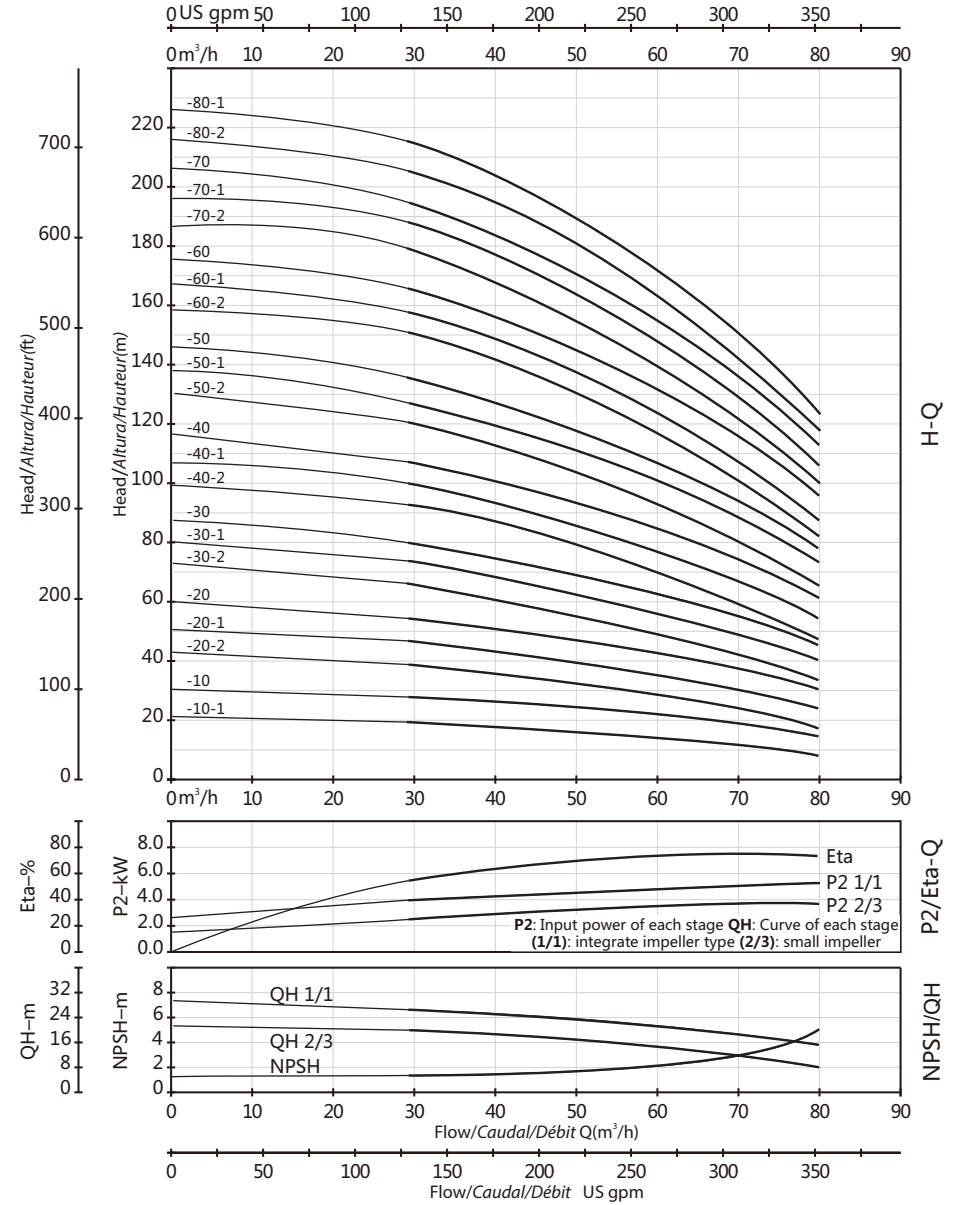

PVT(S)90

2900rpm

PERFORMANCE CURVE/CURVA DE RENDIMIENTO/COURBE DE PERFORMANCE

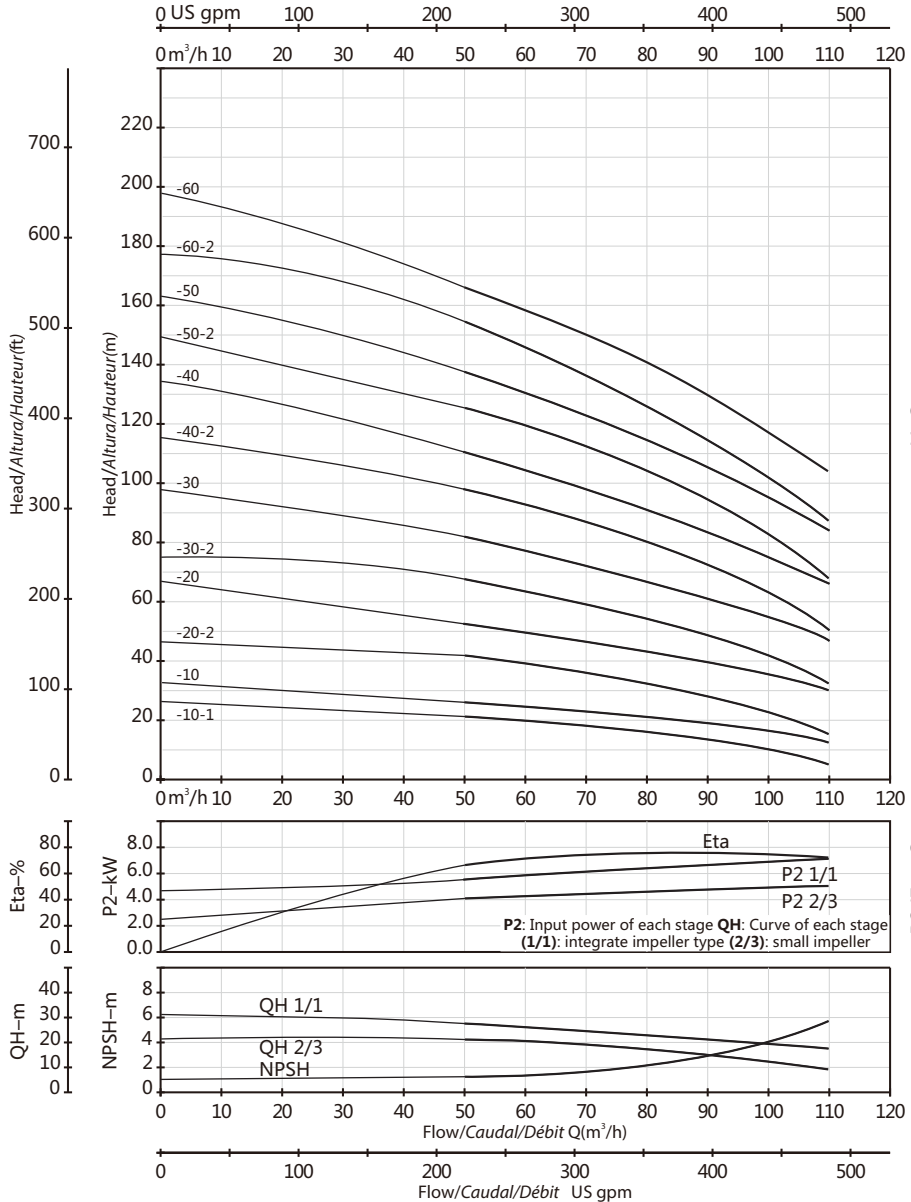

GENERAL SALES CONDITIONS

1) ORDERS: Any order sent to us, whether by our representatives or by letter, telephone or fax, will be considered definite only after our regular acceptance in writing. 2) DELIVERY: The terms indicated for delivery are not binding but subject to manufacturing factors and unforeseeable circumstances (trade unions unrest, breakdown of machinery, late delivery by our suppliers, general unavailability of raw materials, fire, flood or other forces majeure). Any delay which might occur will not give rise on the part of the purchaser of the right to annul the order or to claim damages. 3) TRANSPORT: Goods travel at the customer's risk even if the price is stated as carriage free. The vendor will not be liable for the underweight goods or damage caused during transit as the carrier is exclusively liable in such cases and it is to him that the receiving party must promptly address a right informative notice in writing to this to the dealer. After 8 days have passed from receipt of the goods, no claims are in any case ammissible. 4) PRICES: The prices are to be understood as net of tax duties and may be changed without notice. 5) RIGHT OF PROPERTY: The goods property belongs to the manufacturer and it is not acquired by the customer until the complete payment is made for the goods, and for any interest and costs involved. In case of payment not honoured, goods will, on the manufacturer's express request, be promptly sent back to the stores in free port indicated by the manufacturer. In any case the manufacturer reserves the right to charge the customer with the cost of restoration and renewal of returned goods. 6) PAYMENTS: Payments must be effected at due dates and in the terms agreed at our Headquarters. Payments made to agents, representatives or others are not recognized even by bills unless there is an express written authority by the manufacturer. In case of payment by instalments the failure to pay even one instalment allows the manufacturer to require the balance immediately plus the interest accrued at the average rate in force for the period. 7) BLOCKAGE OF CLAIMS: The customer may not, for any reason, delay or suspend payments owed on any account even if claims or disputes have arisen, nor may he start or take legal action of any kind if he has not first paid by the terms and in the terms agreed. 8) TECHNICAL CHARACTERISTICS: The technical data and characteristics stated in all the manufacturer's official publications refer to indicative nominal values. For specific needs and on explicit demand, the manufacturer can provide detailed technical sheets from which the internal acceptance criteria of the product can be deduced. The manufacturer reserves the right to make any modification without prior notice. Therefore weights, dimensions, performances and any other stated issues are indicative only and not binding.



CONDICIONES GENERALES DE VENTA

1) PEDIDOS: Cualquier pedido transmitidosnos, ya sea por medio de nuestros agentes, ya sea por medio de carta, teléfono o fax, se considera defniti vno sólo después de nuestra regular aceptación por escrito. 2) ENTREGA: Los términos indicados para la entrega no resultan obligativos sino que están sometidos a las posibilidades de fabricación o a fuerzas mayores (movimientos sindicales, averías de las maquinárias, entrega retrasada por parte de los proveedores, condiciones generales por las que las materias primas resultan imposibles de hallar, incendios, inundaciones o otras fuerzas mayores). Un retraso eventual no puede resultar por parte del comprador en cancelación del pedido ni en pretensión de indemnización. 3) ENVIO: La mercancía viaja por cuenta y riesgo del remitente aun si su precio está fijado franco domicilio del comprador. No se responde de algún daño debido a falta de peso o a averías de viaje ya que por eso resulta responsable solamente y exclusivamente el transportista al que el desti natario debe rápidamente elevar reserva antes de retirar la mercancía y de eso dar comunicación por escrito también al cesionario. Transcurridos 8 días de la data de recepción de la mercancía no se admiten más reclamaciones. 4) PRECIOS: Los precios se entienden libres de gravámenes fiscales pueden variarse sin previo aviso. 5) RESERVA DE PROPIEDAD: La propiedad de los bienes entregados es del fabricante y pasa al cliente sólo después del pago integral del precio, de los intereses y de los gastos debidos. En caso de incumplimiento la mercancía será, sobre expreso pedido del fabricante, rápidamente devuelta a los depósitos del fabricante indicados puerto franco. El fabricante se reserva el derecho de adeudar al cliente los gastos soportados para la regeneración y renovación del material devuelto. 6) PAGOS: Los pagos deben efectuarse al vencimiento y según las modalidades establecidas, a nuestra sede. No se reconocen pagos efectuados a agentes, representantes o otras personas aun si por medio de efectos, salvo expresa autorización del fabricante por escrito. En caso de pago dilacionado, la falta de pago aun de una rata solamente permite al fabricante de exigir el saldo destinatario del crédito residuo añadido de los intereses devengados al tipo medio en vigor en aquel período. 7) ACCION PROHIBIDA: El cliente no puede por ninguna razón retrasar o suspender los pagos debidos a cualquier título, aun si hubieran recl maciones o contestaciones, ni puede entablar o continuar acciones judiciales de cualquier tipo si antes no haya tomado medidas para el pago dentro de los términos y según las modalidades establecidas. 8) CARACTERISTICAS TECNICAS: Los datos y las características citadas en todas las publicaciones oficiales del fabricante, se refieren a valores nominales indicativos. Para responder a especificas necesidades y bajo explicita demanda, el fabricante dispone de fichas técnicas detalladas donde se pueden deducir los criterios de aceptación interna del producto. El fabri cante se reserva el derecho de aportar cualquier modificación sin previo aviso: por lo tanto pesos, medidas, prestaciones y demás informaciones no son vinculantes sino que indicativos.



CONDITIONS GENERALES DE VENTE

1) COMMANDES: Toute commande, faite par l'intermédiaire de nos agents, par lettre, par téléphone ou encore par télécopie, doit être considérée définie seulement après acceptation écrite de notre part. 2) LIVRAISON: Les délais indiqués pour la livraison ne nous engagent pas, mais ils sont subordonnés aux possibilités de fabrication et aux cas de force majeure (agitations syndicales, dégâts aux machineries, livraison différée de la part des fournisseurs, situations générales d'impossibilité de trouver les matières premières, incendies, inondations, ou d'autres causes de force majeure). Un retard éventuel ne peut pas déterminer, de la part de l'acheteur, l'annulation de la commande ni la prétention d'un dédommagement. 3) EXPEDITION: Les marchandises voyagent au risque et péril du commettant même si le prix est établi franco destination. Nous ne répondons pas des réclamations dues à faute de poids ni à avaries de voyage, étant responsable de cela uniquement et exclusivement le transporteur au quel destinataire doit promptement dresser une réserve avant de retirer la marchandise et communiquer cela par écrit, pour information, même au cessionnaire. Après 8 jours à calculer à partir de la date de réception des marchandises, aucune pas au clients sinon après paiement intégral du prix, des intérêts et des frais dus. En cas de défaillance, la marchandise sera livrée de nouveau, sur demande précise du fabricant, aux dépôts indiqués par le fabricant franco de port. De toute façon le fabricant se réserve la faculté de débiter au client les frais supportés pour la régénération et la mise à neuf du matériel rendu. 4) PAIEMENTS: Les paiements doivent être effectués à l'échéance et selon les formes convenues dans notre siège. Le paiement faits à agents, représentants ou autres même si au moyen d'effets ne sont pas reconnus, sauf précise autorisation écrite de la part du fabricant. En cas de paiement échelonné, le non-paiement même d'un seul versement permet au fabricant d'exiger le solde immédiat du crédit restant augmenté des intérêts rapportés au taux moyen en vigueur dans cette période. 7) DEFENSE D'ACTION: Le client ne peut, pour aucune raison, différer ni suspendre les paiements dus à réclamation n'est acceptée. 4) PRIX: les prix s'entendent nets des charges fiscales et peuvent être variés sans que le fabricant soit obligée de donner un préavis. 5) RESERVE DE PROPRIETE: La propriété des biens livrés reste au fabricant et ne passe n'importe quel titre, même si des réclamations ou des contestations ont surgi. En outre, il ne peut ni tenter ni poursuivre aucune action en justice de n'importe quel genre, si, avant cela, il n'a pas pourvu au paiement dans les termes et les formes convenus. 8) CARACTERISTIQUES TECHNIQUES: Les données et les caractéristiques techniques citées dans toutes les publications officielles du fabricant se rapportent à des valeurs nominales indicatives. Sur demande et pour des nécessités spécifiques, le fabricant peut mettre à disposition des fiches techniques des produits détaillées par lesquelles on peut déduire aussi les critères de recevabilité technique interne des produits. Le fabricant se réserve le droit d'apporter n'importe quelle modification sans aucun préavis; par conséquent les poids, les mesures les performances et tout ce qui est indiqué ne sont pas contraignants mais simplement indicatifs.

По вопросам продаж и поддержки обращайтесь:

Алматы (7273)495-231
Архангельск (8182)63-90-72
Астрахань (8512)99-46-04
Барнаул (3852)73-04-60
Белгород (4722)40-23-64
Брянск (4832)59-03-52
Владивосток (423)249-28-31
Волгоград (844)278-03-48
Вологда (8172)26-41-59
Воронеж (473)204-51-73
Екатеринбург (343)384-55-89
Иваново (4932)77-34-06
Ижевск (3412)26-03-58
Иркутск (395)279-98-46
Россия (495)268-04-70

Казань (843)206-01-48
Калининград (4012)72-03-81
Калуга (4842)92-23-67
Кемерово (3842)65-04-62
Киров (8332)68-02-04
Краснодар (861)203-40-90
Красноярск (391)204-63-61
Курск (4712)77-13-04
Липецк (4742)52-20-81
Магнитогорск (3519)55-03-13
Москва (495)268-04-70
Мурманск (8152)59-64-93
Набережные Челны (8552)20-53-41
Нижний Новгород (831)429-08-12
Киргизия (996)312-96-26-47

Новокузнецк (3843)20-46-81
Новосибирск (383)227-86-73
Омск (3812)21-46-40
Орел (4862)44-53-42
Оренбург (3532)37-68-04
Пенза (8412)22-31-16
Пермь (342)205-81-47
Ростов-на-Дону (863)308-18-15
Рязань (4912)46-61-64
Самара (846)206-03-16
Санкт-Петербург (812)309-46-40
Саратов (845)249-38-78
Севастополь (8692)22-31-93
Симферополь (3652)67-13-56
Казахстан (7172)727-132

Смоленск (4812)29-41-54
Сочи (862)225-72-31
Ставрополь (8652)20-65-13
Сургут (3462)77-98-35
Тверь (4822)63-31-35
Томск (3822)98-41-53
Тула (4872)74-02-29
Тюмень (3452)66-21-18
Ульяновск (8422)24-23-59
Уфа (347)229-48-12
Хабаровск (4212)92-98-04
Челябинск (351)202-03-61
Череповец (8202)49-02-64
Ярославль (4852)69-52-93